

PHYSICS

PART I

TEXTBOOK FOR CLASS XI



11086

विद्यया ऽ मृतमश्नुते



एन सी ई आर टी
NCERT

राष्ट्रीय शैक्षिक अनुसंधान और प्रशिक्षण परिषद्
NATIONAL COUNCIL OF EDUCATIONAL RESEARCH AND TRAINING

11086 – PHYSICS (PART I)

Textbook for Class XI

ISBN 81-7450-508-3

First Edition

February 2006 Phalguna 1927

Reprinted

October 2006, December 2007,
January 2009, January 2010,
January 2011, March 2012,
November 2012, November 2013,
December 2014, May 2016,
February 2017, December 2017,
January 2019, October 2019,
January 2021, July 2021 and
November 2021

Revised Edition

November 2022 Kartika 1944

Reprinted

March 2024 Chaitra 1946

PD 360T SU

© National Council of Educational
Research and Training, 2006, 2022

₹ 160.00

Printed on 80 GSM paper with NCERT
watermark

Published at the Publication Division by the
Secretary, National Council of Educational
Research and Training, Sri Aurobindo Marg,
New Delhi 110016 and printed at New King
Offset Press, D-18-19, Udyog Puram,
Industrial Area, Delhi Road, Meerut City,
Meerut-250 002 (UP)

ALL RIGHTS RESERVED

- ❑ No part of this publication may be reproduced, stored in a retrieval system or transmitted, in any form or by any means, electronic, mechanical, photocopying, recording or otherwise without the prior permission of the publisher.
- ❑ This book is sold subject to the condition that it shall not, by way of trade, be lent, re-sold, hired out or otherwise disposed of without the publisher's consent, in any form of binding or cover other than that in which it is published.
- ❑ The correct price of this publication is the price printed on this page. Any revised price indicated by a rubber stamp or by a sticker or by any other means is incorrect and should be unacceptable.

OFFICES OF THE PUBLICATION DIVISION, NCERT

NCERT Campus
Sri Aurobindo Marg
New Delhi 110 016

Phone : 011-26562708

108, 100 Feet Road
Hosdakere Halli Extension
Banashankari III Stage
Bengaluru 560 085

Phone : 080-26725740

Navjivan Trust Building
P.O. Navjivan
Ahmedabad 380 014

Phone : 079-27541446

CWC Campus
Opp. Dhankal Bus Stop
Panihati
Kolkata 700 114

Phone : 033-25530454

CWC Complex
Maligaon
Guwahati 781 021

Phone : 0361-2674869

Publication Team

Head, Publication Division : Anup Kumar Rajput
Chief Editor : Shveta Uppal
Chief Production Officer : Arun Chitkara
Chief Business Manager (In charge) : Amitabh Kumar
Editor : R.N. Bhardwaj
Assistant Production Officer : Om Prakash

Cover and Illustrations
Shweta Rao

FOREWORD

The National Curriculum Framework (NCF), 2005 recommends that children's life at school must be linked to their life outside the school. This principle marks a departure from the legacy of bookish learning which continues to shape our system and causes a gap between the school, home and community. The syllabi and textbooks developed on the basis of NCF signify an attempt to implement this basic idea. They also attempt to discourage rote learning and the maintenance of sharp boundaries between different subject areas. We hope these measures will take us significantly further in the direction of a child-centred system of education outlined in the National Policy on Education (1986).

The success of this effort depends on the steps that school principals and teachers will take to encourage children to reflect on their own learning and to pursue imaginative activities and questions. We must recognise that, given space, time and freedom, children generate new knowledge by engaging with the information passed on to them by adults. Treating the prescribed textbook as the sole basis of examination is one of the key reasons why other resources and sites of learning are ignored. Inculcating creativity and initiative is possible if we perceive and treat children as participants in learning, not as receivers of a fixed body of knowledge.

These aims imply considerable change in school routines and mode of functioning. Flexibility in the daily time-table is as necessary as rigour in implementing the annual calendar so that the required number of teaching days are actually devoted to teaching. The methods used for teaching and evaluation will also determine how effective this textbook proves for making children's life at school a happy experience, rather than a source of stress or boredom. Syllabus designers have tried to address the problem of curricular burden by restructuring and reorienting knowledge at different stages with greater consideration for child psychology and the time available for teaching. The textbook attempts to enhance this endeavour by giving higher priority and space to opportunities for contemplation and wondering, discussion in small groups, and activities requiring hands-on experience.

The National Council of Educational Research and Training (NCERT) appreciates the hard work done by the textbook development committee responsible for this book. We wish to thank the Chairperson of the advisory group in science and mathematics, Professor J.V. Narlikar and the Chief Advisor for this book, Professor A.W. Joshi for guiding the work of this committee. Several teachers contributed to the development of this textbook; we are grateful to their principals for making this possible. We are indebted to the institutions and organisations which have generously permitted us to draw upon their resources, material and personnel. We are especially grateful to the members of the National Monitoring Committee, appointed by the Department of Secondary and Higher Education, Ministry of Human Resource Development under the Chairpersonship of Professor Mrinal Miri and Professor G.P. Deshpande, for their valuable time and contribution. As an organisation committed to systemic reform and continuous improvement in the quality of its products, NCERT welcomes comments and suggestions which will enable us to undertake further revision and refinement.

New Delhi
20 December 2005

Director
National Council of Educational
Research and Training

© NCERT
not to be republished

RATIONALISATION OF CONTENT IN THE TEXTBOOKS

In view of the COVID-19 pandemic, it is imperative to reduce content load on students. The National Education Policy 2020, also emphasises reducing the content load and providing opportunities for experiential learning with creative mindset. In this background, the NCERT has undertaken the exercise to rationalise the textbooks across all classes. Learning Outcomes already developed by the NCERT across classes have been taken into consideration in this exercise.

Contents of the textbooks have been rationalised in view of the following:

- Overlapping with similar content included in other subject areas in the same class
- Similar content included in the lower or higher class in the same subject
- Difficulty level
- Content, which is easily accessible to students without much interventions from teachers and can be learned by children through self-learning or peer-learning
- Content, which is irrelevant in the present context

This present edition, is a reformatted version after carrying out the changes given above.

© NCERT
not to be republished

TEXTBOOK DEVELOPMENT COMMITTEE

CHAIRPERSON, ADVISORY GROUP FOR TEXTBOOKS IN SCIENCE AND MATHEMATICS

J.V. Narlikar, *Emeritus Professor*, Chairman, Advisory Committee, Inter University Centre for Astronomy and Astrophysics (IUCAA), Ganeshkhind, Pune University, Pune

CHIEF ADVISOR

A.W. Joshi, *Professor*, Honorary Visiting Scientist, NCRA, Pune (Formerly at Department of Physics, University of Pune)

MEMBERS

Anuradha Mathur, *PGT*, Modern School, Vasant Vihar, New Delhi

Chitra Goel, *PGT*, Rajkiya Pratibha Vikas Vidyalaya, Tyagraj Nagar, Lodhi Road, New Delhi

Gagan Gupta, *Reader*, DESM, NCERT, New Delhi

H.C. Pradhan, *Professor*, Homi Bhabha Centre of Science Education, Tata Institute of Fundamental Research, V.N. Purav Marg, Mankhurd, Mumbai

N. Panchapakesan, *Professor (Retd.)*, Department of Physics and Astrophysics, University of Delhi, Delhi

P.K. Srivastava, *Professor (Retd.)*, Director, CSEC, University of Delhi, Delhi

P.K. Mohanty, *PGT*, Sainik School, Bhubaneswar

P.C. Agarwal, *Reader*, Regional Institute of Education, NCERT, Sachivalaya Marg, Bhubaneswar

R. Joshi, *Lecturer (S.G.)*, DESM, NCERT, New Delhi

S. Rai Choudhary, *Professor*, Department of Physics and Astrophysics, University of Delhi, Delhi

S.K. Dash, *Reader*, DESM, NCERT, New Delhi

Sher Singh, *PGT*, NDMC Navyug School, Lodhi Road, New Delhi

S.N. Prabhakara, *PGT*, DM School, Regional Institute of Education, NCERT, Mysore

Thiyam Jekendra Singh, *Professor*, Department of Physics, University of Manipur, Imphal

V.P. Srivastava, *Reader*, DESM, NCERT, New Delhi

MEMBER-COORDINATOR

B.K. Sharma, *Professor*, DESM, NCERT, New Delhi

ACKNOWLEDGEMENTS

The National Council of Educational Research and Training acknowledges the valuable contribution of the individuals and organisations involved in the development of Physics textbook for Class XI. The Council also acknowledges the valuable contribution of the following academics for reviewing and refining the manuscripts of this book: Deepak Kumar, *Professor*, School of Physical Sciences, Jawaharlal Nehru University, New Delhi; Pankaj Sharan, *Professor*, Jamia Millia Islamia, New Delhi; Ajoy Ghatak, *Emeritus Professor*, Indian Institute of Technology, New Delhi; V. Sundara Raja, *Professor*, Sri Venkateswara University, Tirupati, Andhra Pradesh; C.S. Adgaonkar, *Reader (Retd)*, Institute of Science, Nagpur, Maharashtra; D.A. Desai, *Lecturer (Retd)*, Ruparel College, Mumbai, Maharashtra; F.I. Surve, *Lecturer*, Nowrosjee Wadia College, Pune, Maharashtra; Atul Mody, *Lecturer (SG)*, VES College of Arts, Science and Commerce, Chembur, Mumbai, Maharashtra; A.K. Das, *PGT*, St. Xavier's Senior Secondary School, Delhi; Suresh Kumar, *PGT*, Delhi Public School, Dwarka, New Delhi; Yashu Kumar, *PGT*, Kulachi Hansraj Model School, Ashok Vihar, Delhi; K.S. Upadhyay, *PGT*, Jawahar Navodaya Vidyalaya, Muzaffar Nagar (U.P.); I.K. Gogia, *PGT*, Kendriya Vidyalaya, Gole Market, New Delhi; Vijay Sharma, *PGT*, Vasant Valley School, Vasant Kunj, New Delhi; R.S. Dass, *Vice Principal (Retd)*, Balwant Ray Mehta Vidya Bhawan, Lajpat Nagar, New Delhi and Parthasarathi Panigrahi, *PGT*, D.V. CLW Girls School, Chittranjan, West Bengal.

The Council also gratefully acknowledges the valuable contribution of the following academics for the editing and finalisation of this book: A.S. Mahajan, *Professor (Retd)*, Indian Institute of Technology, Mumbai, Maharashtra; D.A. Desai, *Lecturer (Retd)*, Ruparel College, Mumbai, Maharashtra; V.H. Raybagkar, *Reader*, Nowrosjee Wadia College, Pune, Maharashtra and Atul Mody, *Lecturer (SG)*, VES College of Arts, Science and Commerce, Chembur, Mumbai, Maharashtra.

The council also acknowledges the valuable contributions of the following academics for reviewing and refining the text in 2017: A.K. Srivastava, DESM, NCERT, New Delhi; Arnab Sen, NERIE, New Delhi; L.S. Chauhan, RIE, Bhopal; O.N. Awasthi (*Retd.*), RIE., Bhopal; Rachna Garg, DESM, NCERT, New Delhi; Raman Namboodiri, RIE, Mysuru; R.R. Koireng, DCS, NCERT, New Delhi; Shashi Prabha, DESM, NCERT, New Delhi; and S.V. Sharma, RIE, Ajmer.

Special thanks are due to M. Chandra, *Professor and Head*, DESM, NCERT for her support.

The Council also acknowledges the efforts of Deepak Kapoor, *Incharge*, Computer Station, Inder Kumar, *DTP Operator*; Saswati Banerjee, *Copy Editor*; Abhimanu Mohanty and Anuradha, *Proof Readers* in shaping this book.

The contributions of the Publication Department in bringing out this book are also duly acknowledged.

PREFACE

More than a decade ago, based on National Policy of Education (NPE-1986), National Council of Educational Research and Training published physics textbooks for Classes XI and XII, prepared under the chairmanship of Professor T. V. Ramakrishnan, F.R.S., with the help of a team of learned co-authors. The books were well received by the teachers and students alike. The books, in fact, proved to be milestones and trend-setters. However, the development of textbooks, particularly science books, is a dynamic process in view of the changing perceptions, needs, feedback and the experiences of the students, educators and the society. Another version of the physics books, which was the result of the revised syllabus based on *National Curriculum Framework for School Education-2000* (NCFSE-2000), was brought out under the guidance of Professor Suresh Chandra, which continued up to now. Recently the NCERT brought out the *National Curriculum Framework-2005* (NCF-2005), and the syllabus was accordingly revised during a curriculum renewal process at school level. The higher secondary stage syllabus (NCERT, 2005) has been developed accordingly. The Class XI textbook contains fifteen chapters in two parts. Part I contains first eight chapters while Part II contains next seven chapters. This book is the result of the renewed efforts of the present Textbook Development Team with the hope that the students will appreciate the beauty and logic of physics. The students may or may not continue to study physics beyond the higher secondary stage, but we feel that they will find the thought process of physics useful in any other branch they may like to pursue, be it finance, administration, social sciences, environment, engineering, technology, biology or medicine. For those who pursue physics beyond this stage, the matter developed in these books will certainly provide a sound base.

Physics is basic to the understanding of almost all the branches of science and technology. It is interesting to note that the ideas and concepts of physics are increasingly being used in other branches such as economics and commerce, and behavioural sciences too. We are conscious of the fact that some of the underlying simple basic physics principles are often conceptually quite intricate. In this book, we have tried to bring in a conceptual coherence. The pedagogy and the use of easily understandable language are at the core of our effort without sacrificing the **rigour** of the subject. The nature of the subject of physics is such that a certain minimum use of mathematics is a must. We have tried to develop the mathematical formulations in a logical fashion, as far as possible.

Students and teachers of physics must realise that physics is a branch which needs to be understood, not necessarily memorised. As one goes from secondary to higher secondary stage and beyond, physics involves mainly four components, (a) large amount of **mathematical base**, (b) **technical words and terms**, whose normal English meanings could be quite different, (c) new **intricate concepts**, and (d) **experimental foundation**. Physics needs mathematics because we wish to develop objective description of the world around us and express our observations in terms of measurable quantities. Physics discovers new properties of particles and wants to create a name for each one. The words are picked up normally from common English or Latin or Greek, but gives entirely different meanings to these words. It would be illuminating to look up words like energy, force, power, charge, spin, and several others, in any standard English dictionary, and compare their

meanings with their physics meanings. Physics develops intricate and often weird-looking concepts to explain the behaviour of particles. Finally, it must be remembered that entire physics is based on observations and experiments, without which a theory does not get acceptance into the domain of physics.

This book has some features which, we earnestly hope, will enhance its usefulness for the students. Each chapter is provided with a **Summary** at its end for a quick overview of the contents of the chapter. This is followed by **Points to Ponder** which points out the likely misconceptions arising in the minds of students, hidden implications of certain statements/principles given in the chapter and **cautions** needed in applying the knowledge gained from the chapter. They also raise some thought-provoking questions which would make a student think about life beyond physics. Students will find it interesting to think and apply their mind on these **points**. Further, a large number of **solved examples** are included in the text in order to clarify the concepts and/or to illustrate the application of these concepts in everyday real-life situations. Occasionally, historical perspective has been included to share the excitement of sequential development of the subject of physics. Some **Boxed** items are introduced in many chapters either for this purpose or to highlight some special features of the contents requiring additional attention of the learners. Finally, a **Subject Index** has been added at the end of the book for ease in locating keywords in the book.

The special nature of physics demands, apart from conceptual understanding, the knowledge of certain conventions, basic mathematical tools, numerical values of important physical constants, and systems of measurement units covering a vast range from microscopic to galactic levels. In order to equip the students, we have included the necessary tools and database in the form of **Appendices A-1 to A-9** at the end of the book. There are also some other appendices at the end of some chapters giving additional information or applications of matter discussed in that chapter.

Special attention has been paid for providing illustrative figures. To increase the clarity, the figures are drawn in two colours. A large number of **Exercises** are given at the end of each chapter. Some of these are from real-life situations. Students are urged to solve these and in doing so, they may find them very educational. Moreover, some **Additional Exercises** are given which are more challenging. Answers and hints to solve some of these are also included. In the entire book, SI units have been used. A comprehensive account of 'units and measurement' is given in Chapter 2 as a part of prescribed syllabus/curriculum as well as a help in their pursuit of physics. A box-item in this chapter brings out the difficulty in measuring as simple a thing as the length of a long curved line. Tables of SI base units and other related units are given here merely to indicate the presently accepted definitions and to indicate the high degree of accuracy with which measurements are possible today. The numbers given here are not to be memorised or asked in examinations.

There is a perception among students, teachers, as well as the general public that there is a steep gradient between secondary and higher secondary stages. But a little thought shows that it is bound to be there in the present scenario of education. Education up to secondary stage is general education where a student has to learn several subjects – sciences, social sciences, mathematics, languages, at an elementary level. Education at the higher secondary stage and beyond, borders on acquiring professional competence, in some chosen fields of endeavour. You may like to compare this with the following situation. Children play cricket or badminton in lanes and small spaces outside (or inside) their homes. But then

some of them want to make it to the school team, then district team, then State team and then the National team. At every stage, there is bound to be a steep gradient. Hard work would have to be put in whether students want to pursue their education in the area of sciences, humanities, languages, music, fine arts, commerce, finance, architecture, or if they want to become sportspersons or fashion designers.

Completing this book has only been possible because of the spontaneous and continuous support of many people. The Textbook Development Team is thankful to Dr. V. H. Raybagkar for allowing us to use his box item in Chapter 4 and to Dr. F. I. Surve for allowing us to use two of his box items in Chapter 15. We express also our gratitude to the Director, NCERT, for entrusting us with the task of preparing this textbook as a part of national effort for improving science education. The Head, Department of Education in Science and Mathematics, NCERT, was always willing to help us in our endeavour in every possible way.

The previous text got excellent academic inputs from teachers, students and experts who sincerely suggested improvement during the past few years. We are thankful to all those who conveyed these inputs to NCERT. We are also thankful to the members of the Review Workshop and Editing Workshop organised to discuss and refine the first draft. We thank the Chairmen and their teams of authors for the text written by them in 1988, which provided the base and reference for developing the 2002 version as well as the present version of the textbook. Occasionally, substantial portions from the earlier versions, particularly those appreciated by students/teachers, have been adopted/adapted and retained in the present book for the benefit of coming generation of learners.

We welcome suggestions and comments from our valued users, especially students and teachers. We wish our young readers a happy journey to the exciting realm of physics.

A. W. JOSHI
Chief Advisor

Textbook Development Committee

A NOTE FOR THE TEACHERS

To make the curriculum learner-centred, students should be made to participate and interact in the learning process directly. Once a week or one out of every six classes would be a good periodicity for such seminars and mutual interaction. Some suggestions for making the discussion participatory are given below, with reference to some specific topics in this book.

Students may be divided into groups of five to six. The membership of these groups may be rotated during the year, if felt necessary.

The topic for discussion can be presented on the board or on slips of paper. Students should be asked to write their reactions or answers to questions, whichever is asked, on the given sheets. They should then discuss in their groups and add modifications or comments in those sheets. These should be discussed either in the same or in a different class. The sheets may also be evaluated.

We suggest here three possible topics from the book. The first two topics suggested are, in fact, very general and refer to the development of science over the past four centuries or more. Students and teachers may think of more such topics for each seminar.

1. Ideas that changed civilisation

Suppose human beings are becoming extinct. A message has to be left for future generations or alien visitors. Eminent physicist R P Feynmann wanted the following message left for future beings, if any.

“Matter is made up of atoms”

A lady student and teacher of literature, wanted the following message left:

“Water existed, so human beings could happen”.

Another person thought it should be: **“Idea of wheel for motion”**

Write down what message each one of you would like to leave for future generations. Then discuss it in your group and add or modify, if you want to change your mind. Give it to your teacher and join in any discussion that follows.

2. Reductionism

Kinetic Theory of Gases relates the Big to the Small, the Macro to the Micro. A gas as a system is related to its components, the molecules. This way of describing a system as a result of the properties of its components is usually called **Reductionism**. It explains the behaviour of the group by the simpler and predictable behaviour of individuals. Macroscopic observations and microscopic properties have a mutual interdependence in this approach. Is this method useful?

This way of understanding has its limitations outside physics and chemistry, may be even in these subjects. A painting **cannot** be discussed as a collection of the properties of chemicals used in making the canvas and the painting. What emerges is more than the sum of its components.

Question: Can you think of other areas where such an approach is used?

Describe briefly a system which is fully describable in terms of its components. Describe one which is not. Discuss with other members of the group and write your views. Give it to your teacher and join in any discussion that may follow.

3. Molecular approach to heat

Describe what you think will happen in the following case. An enclosure is separated by a porous wall into two parts. One is filled with nitrogen gas (N_2) and the other with CO_2 . Gases will diffuse from one side to the other.

Question 1: Will both gases diffuse to the same extent? If not, which will diffuse more. Give reasons.

Question 2: Will the pressure and temperature be unchanged? If not, what will be the changes in both. Give reasons.

Write down your answers. Discuss with the group and modify them or add comments. Give to the teacher and join in the discussion.

Students and teachers will find that such seminars and discussions lead to tremendous understanding, not only of physics, but also of science and social sciences. They also bring in some maturity among students.

CONTENTS

| | |
|--|------------|
| FOREWORD | <i>iii</i> |
| RATIONALISATION OF CONTENT IN THE TEXTBOOKS | <i>v</i> |
| PREFACE | <i>ix</i> |
| A NOTE FOR THE TEACHER | <i>xii</i> |
| | |
| CHAPTER 1 | |
| UNITS AND MEASUREMENTS | |
| 1.1 Introduction | 1 |
| 1.2 The international system of units | 1 |
| 1.3 Significant figures | 3 |
| 1.4 Dimensions of physical quantities | 7 |
| 1.5 Dimensional formulae and dimensional equations | 7 |
| 1.6 Dimensional analysis and its applications | 7 |
| | |
| CHAPTER 2 | |
| MOTION IN A STRAIGHT LINE | |
| 2.1 Introduction | 13 |
| 2.2 Instantaneous velocity and speed | 14 |
| 2.3 Acceleration | 15 |
| 2.4 Kinematic equations for uniformly accelerated motion | 17 |
| | |
| CHAPTER 3 | |
| MOTION IN A PLANE | |
| 3.1 Introduction | 27 |
| 3.2 Scalars and vectors | 27 |
| 3.3 Multiplication of vectors by real numbers | 29 |
| 3.4 Addition and subtraction of vectors – graphical method | 29 |
| 3.5 Resolution of vectors | 31 |
| 3.6 Vector addition – analytical method | 33 |
| 3.7 Motion in a plane | 34 |
| 3.8 Motion in a plane with constant acceleration | 37 |
| 3.9 Projectile motion | 38 |
| 3.10 Uniform circular motion | 40 |
| | |
| CHAPTER 4 | |
| LAWS OF MOTION | |
| 4.1 Introduction | 49 |
| 4.2 Aristotle's fallacy | 50 |
| 4.3 The law of inertia | 50 |
| 4.4 Newton's first law of motion | 51 |
| 4.5 Newton's second law of motion | 53 |
| 4.6 Newton's third law of motion | 56 |

| | | |
|-------------|-------------------------------|----|
| 4.7 | Conservation of momentum | 57 |
| 4.8 | Equilibrium of a particle | 58 |
| 4.9 | Common forces in mechanics | 59 |
| 4.10 | Circular motion | 63 |
| 4.11 | Solving problems in mechanics | 64 |

CHAPTER 5

WORK, ENERGY AND POWER

| | | |
|-------------|--|----|
| 5.1 | Introduction | 71 |
| 5.2 | Notions of work and kinetic energy : The work-energy theorem | 73 |
| 5.3 | Work | 73 |
| 5.4 | Kinetic energy | 74 |
| 5.5 | Work done by a variable force | 75 |
| 5.6 | The work-energy theorem for a variable force | 76 |
| 5.7 | The concept of potential energy | 77 |
| 5.8 | The conservation of mechanical energy | 78 |
| 5.9 | The potential energy of a spring | 80 |
| 5.10 | Power | 83 |
| 5.11 | Collisions | 83 |

CHAPTER 6

SYSTEM OF PARTICLES AND ROTATIONAL MOTION

| | | |
|-------------|--|-----|
| 6.1 | Introduction | 92 |
| 6.2 | Centre of mass | 95 |
| 6.3 | Motion of centre of mass | 99 |
| 6.4 | Linear momentum of a system of particles | 100 |
| 6.5 | Vector product of two vectors | 101 |
| 6.6 | Angular velocity and its relation with linear velocity | 103 |
| 6.7 | Torque and angular momentum | 105 |
| 6.8 | Equilibrium of a rigid body | 108 |
| 6.9 | Moment of inertia | 114 |
| 6.10 | Kinematics of rotational motion about a fixed axis | 116 |
| 6.11 | Dynamics of rotational motion about a fixed axis | 118 |
| 6.12 | Angular momentum in case of rotations about a fixed axis | 120 |

CHAPTER 7

GRAVITATION

| | | |
|------------|--|-----|
| 7.1 | Introduction | 127 |
| 7.2 | Kepler's laws | 128 |
| 7.3 | Universal law of gravitation | 129 |
| 7.4 | The gravitational constant | 131 |
| 7.5 | Acceleration due to gravity of the earth | 132 |
| 7.6 | Acceleration due to gravity below and above the surface of earth | 133 |

| | | |
|-------------|---------------------------------|-----|
| 7.7 | Gravitational potential energy | 134 |
| 7.8 | Escape speed | 135 |
| 7.9 | Earth satellites | 137 |
| 7.10 | Energy of an orbiting satellite | 138 |
| APPENDICES | | 144 |
| ANSWERS | | 160 |

© NCERT
not to be republished

COVER DESIGN

(Adapted from the website of the Nobel Foundation
<http://www.nobelprize.org>)

The strong nuclear force binds protons and neutrons in a nucleus and is the strongest of nature's four fundamental forces. A mystery surrounding the strong nuclear force has been solved. The three quarks within the proton can sometimes appear to be free, although no free quarks have ever been observed. The quarks have a quantum mechanical property called 'colour' and interact with each other through the exchange of particles called 'gluons' — nature glue.

BACK COVER

(Adapted from the website of the ISRO
<http://www.isro.gov.in>)

CARTOSAT-1 is a state-of-the-art Remote Sensing Satellite, being eleventh one in the Indian Remote Sensing (IRS) Satellite Series, built by ISRO. CARTOSAT-1, having mass of 156 kg at lift off, has been launched into a 618 km high polar Sun Synchronous Orbit (SSO) by ISRO's Polar Satellite Launch Vehicle, PSLV-C6. It is mainly intended for cartographic applications.



UNITS AND MEASUREMENT

| | |
|-----|--|
| 1.1 | Introduction |
| 1.2 | The international system of units |
| 1.3 | Significant figures |
| 1.4 | Dimensions of physical quantities |
| 1.5 | Dimensional formulae and dimensional equations |
| 1.6 | Dimensional analysis and its applications |
| | Summary |
| | Exercises |

1.1 INTRODUCTION

Measurement of any physical quantity involves comparison with a certain basic, arbitrarily chosen, internationally accepted reference standard called **unit**. The result of a measurement of a physical quantity is expressed by a number (or numerical measure) accompanied by a unit. Although the number of physical quantities appears to be very large, we need only a limited number of units for expressing all the physical quantities, since they are inter-related with one another. The units for the fundamental or base quantities are called **fundamental** or **base units**. The units of all other physical quantities can be expressed as combinations of the base units. Such units obtained for the derived quantities are called **derived units**. A complete set of these units, both the base units and derived units, is known as the **system of units**.

1.2 THE INTERNATIONAL SYSTEM OF UNITS

In earlier time scientists of different countries were using different systems of units for measurement. Three such systems, the CGS, the FPS (or British) system and the MKS system were in use extensively till recently.

The base units for length, mass and time in these systems were as follows :

- In CGS system they were centimetre, gram and second respectively.
- In FPS system they were foot, pound and second respectively.
- In MKS system they were metre, kilogram and second respectively.

The system of units which is at present internationally accepted for measurement is the *Système Internationale d' Unites* (French for International System of Units), abbreviated as SI. The SI, with standard scheme of symbols, units and abbreviations, developed by the Bureau International des Poids et mesures (The International Bureau of Weights and Measures, BIPM) in 1971 were recently revised by the General Conference on Weights and Measures in November 2018. The scheme is now for

international usage in scientific, technical, industrial and commercial work. Because SI units used decimal system, conversions within the system are quite simple and convenient. We shall follow the SI units in this book.

In SI, there are seven base units as given in Table 1.1. Besides the seven base units, there are two more units that are defined for (a) plane angle $d\theta$ as the ratio of length of arc ds to the radius r and (b) solid angle $d\Omega$ as the ratio of the intercepted area dA of the spherical surface, described about the apex O as the centre, to the square of its radius r , as shown in Fig. 1.1(a) and (b) respectively. The unit for plane angle is radian with the symbol rad and the unit for the solid angle is steradian with the symbol sr. Both these are dimensionless quantities.

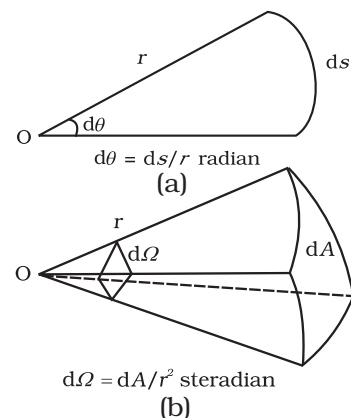

Fig. 1.1 Description of (a) plane angle $d\theta$ and (b) solid angle $d\Omega$.

Table 1.1 SI Base Quantities and Units*

| Base quantity | SI Units | | |
|---------------------------|----------|--------|--|
| | Name | Symbol | Definition |
| Length | metre | m | The metre, symbol m, is the SI unit of length. It is defined by taking the fixed numerical value of the speed of light in vacuum c to be 299792458 when expressed in the unit m s^{-1} , where the second is defined in terms of the caesium frequency $\Delta\nu_{\text{Cs}}$. |
| Mass | kilogram | kg | The kilogram, symbol kg, is the SI unit of mass. It is defined by taking the fixed numerical value of the Planck constant h to be $6.62607015 \times 10^{-34}$ when expressed in the unit J s , which is equal to $\text{kg m}^2 \text{s}^{-1}$, where the metre and the second are defined in terms of c and $\Delta\nu_{\text{Cs}}$. |
| Time | second | s | The second, symbol s, is the SI unit of time. It is defined by taking the fixed numerical value of the caesium frequency $\Delta\nu_{\text{Cs}}$, the unperturbed ground-state hyperfine transition frequency of the caesium-133 atom, to be 9192631770 when expressed in the unit Hz, which is equal to s^{-1} . |
| Electric | ampere | A | The ampere, symbol A, is the SI unit of electric current. It is defined by taking the fixed numerical value of the elementary charge e to be $1.602176634 \times 10^{-19}$ when expressed in the unit C, which is equal to A s, where the second is defined in terms of $\Delta\nu_{\text{Cs}}$. |
| Thermodynamic Temperature | kelvin | K | The kelvin, symbol K, is the SI unit of thermodynamic temperature. It is defined by taking the fixed numerical value of the Boltzmann constant k to be 1.380649×10^{-23} when expressed in the unit J K^{-1} , which is equal to $\text{kg m}^2 \text{s}^{-2} \text{K}^{-1}$, where the kilogram, metre and second are defined in terms of h , c and $\Delta\nu_{\text{Cs}}$. |
| Amount of substance | mole | mol | The mole, symbol mol, is the SI unit of amount of substance. One mole contains exactly $6.02214076 \times 10^{23}$ elementary entities. This number is the fixed numerical value of the Avogadro constant, N_{A} , when expressed in the unit mol^{-1} and is called the Avogadro number. The amount of substance, symbol n , of a system is a measure of the number of specified elementary entities. An elementary entity may be an atom, a molecule, an ion, an electron, any other particle or specified group of particles. |
| Luminous intensity | candela | cd | The candela, symbol cd, is the SI unit of luminous intensity in given direction. It is defined by taking the fixed numerical value of the luminous efficacy of monochromatic radiation of frequency 540×10^{12} Hz, K_{cd} , to be 683 when expressed in the unit lm W^{-1} , which is equal to cd sr W^{-1} , or $\text{cd sr kg}^{-1} \text{m}^{-2} \text{s}^3$, where the kilogram, metre and second are defined in terms of h , c and $\Delta\nu_{\text{Cs}}$. |

* The values mentioned here need not be remembered or asked in a test. They are given here only to indicate the extent of accuracy to which they are measured. With progress in technology, the measuring techniques get improved leading to measurements with greater precision. The definitions of base units are revised to keep up with this progress.

Table 1.2 Some units retained for general use (Though outside SI)

| Name | Symbol | Value in SI Unit |
|-------------------------------|--------|--|
| minute | min | 60 s |
| hour | h | 60 min = 3600 s |
| day | d | 24 h = 86400 s |
| year | y | 365.25 d = 3.156×10^7 s |
| degree | ° | $1^\circ = (\pi/180)$ rad |
| litre | L | $1 \text{ dm}^3 = 10^{-3} \text{ m}^3$ |
| tonne | t | 10^3 kg |
| carat | c | 200 mg |
| bar | bar | $0.1 \text{ MPa} = 10^5 \text{ Pa}$ |
| curie | Ci | $3.7 \times 10^{10} \text{ s}^{-1}$ |
| roentgen | R | $2.58 \times 10^{-4} \text{ C/kg}$ |
| quintal | q | 100 kg |
| barn | b | $100 \text{ fm}^2 = 10^{-28} \text{ m}^2$ |
| are | a | $1 \text{ dam}^2 = 10^2 \text{ m}^2$ |
| hectare | ha | $1 \text{ hm}^2 = 10^4 \text{ m}^2$ |
| standard atmospheric pressure | atm | $101325 \text{ Pa} = 1.013 \times 10^5 \text{ Pa}$ |

Note that when mole is used, the elementary entities must be specified. These entities may be atoms, molecules, ions, electrons, other particles or specified groups of such particles.

We employ units for some physical quantities that can be derived from the seven base units (Appendix A 6). Some derived units in terms of the SI base units are given in (Appendix A 6.1). Some SI derived units are given special names (Appendix A 6.2) and some derived SI units make use of these units with special names and the seven base units (Appendix A 6.3). These are given in Appendix A 6.2 and A 6.3 for your ready reference. Other units retained for general use are given in Table 1.2.

Common SI prefixes and symbols for multiples and sub-multiples are given in Appendix A2. General guidelines for using symbols for physical quantities, chemical elements and nuclides are given in Appendix A7 and those for SI units and some other units are given in Appendix A8 for your guidance and ready reference.

1.3 SIGNIFICANT FIGURES

As discussed above, every measurement involves errors. Thus, the result of measurement should be reported in a way that indicates the precision of measurement. Normally, the reported result of measurement is a number that includes all digits in the number that are known reliably plus the first digit that is uncertain. The reliable digits plus

the first uncertain digit are known as **significant digits** or **significant figures**. If we say the period of oscillation of a simple pendulum is 1.62 s, the digits 1 and 6 are reliable and certain, while the digit 2 is uncertain. Thus, the measured value has three significant figures. The length of an object reported after measurement to be 287.5 cm has four significant figures, the digits 2, 8, 7 are certain while the digit 5 is uncertain. Clearly, reporting the result of measurement that includes more digits than the significant digits is superfluous and also misleading since it would give a wrong idea about the precision of measurement.

The rules for determining the number of significant figures can be understood from the following examples. Significant figures indicate, as already mentioned, the precision of measurement which depends on the least count of the measuring instrument. **A choice of change of different units does not change the number of significant digits or figures in a measurement.** This important remark makes most of the following observations clear:

(1) For example, the length 2.308 cm has four significant figures. But in different units, the same value can be written as 0.02308 m or 23.08 mm or 23080 μm .

All these numbers have the same number of significant figures (digits 2, 3, 0, 8), namely four.

This shows that the location of decimal point is of no consequence in determining the number of significant figures.

The example gives the following rules :

- **All the non-zero digits are significant.**
- **All the zeros between two non-zero digits are significant, no matter where the decimal point is, if at all.**
- **If the number is less than 1, the zero(s) on the right of decimal point but to the left of the first non-zero digit are not significant.** [In 0.00 2308, the underlined zeroes are not significant].
- **The terminal or trailing zero(s) in a number without a decimal point are not significant.**

[Thus 123 m = 12300 cm = 123000 mm has *three* significant figures, the trailing zero(s) being not significant.] However, you can also see the next observation.

- **The trailing zero(s) in a number with a decimal point are significant.**

[The numbers 3.500 or 0.06900 have four significant figures each.]

(2) There can be some confusion regarding the trailing zero(s). Suppose a length is reported to be 4.700 m. It is evident that the zeroes here are meant to convey the precision of measurement and are, therefore, significant. [If these were not, it would be superfluous to write them explicitly, the reported measurement would have been simply 4.7 m]. Now suppose we change units, then

$$4.700 \text{ m} = 470.0 \text{ cm} = 4700 \text{ mm} = 0.004700 \text{ km}$$

Since the last number has trailing zero(s) in a number with no decimal, we would conclude erroneously from observation (1) above that the number has *two* significant figures, while in fact, it has four significant figures and a mere change of units cannot change the number of significant figures.

(3) **To remove such ambiguities in determining the number of significant figures, the best way is to report every measurement in scientific notation (in the power of 10).** In this notation, every number is expressed as $a \times 10^b$, where a is a number between 1 and 10, and b is any positive or

negative exponent (or power) of 10. In order to get an approximate idea of the number, we may round off the number a to 1 (for $a \leq 5$) and to 10 (for $5 < a \leq 10$). Then the number can be expressed approximately as 10^b in which the exponent (or power) b of 10 is called **order of magnitude** of the physical quantity. When only an estimate is required, the quantity is of the order of 10^b . For example, the diameter of the earth ($1.28 \times 10^7 \text{ m}$) is of the order of 10^7 m with the order of magnitude 7. The diameter of hydrogen atom ($1.06 \times 10^{-10} \text{ m}$) is of the order of 10^{-10} m , with the order of magnitude -10 . Thus, the diameter of the earth is 17 orders of magnitude larger than the hydrogen atom.

It is often customary to write the decimal after the first digit. Now the confusion mentioned in (a) above disappears :

$$\begin{aligned} 4.700 \text{ m} &= 4.700 \times 10^2 \text{ cm} \\ &= 4.700 \times 10^3 \text{ mm} = 4.700 \times 10^{-3} \text{ km} \end{aligned}$$

The power of 10 is irrelevant to the determination of significant figures. However, all zeroes appearing in the base number in the scientific notation are significant. Each number in this case has *four* significant figures.

Thus, in the scientific notation, no confusion arises about the trailing zero(s) in the base number a . They are always significant.

(4) The scientific notation is ideal for reporting measurement. But if this is not adopted, we use the rules adopted in the preceding example :

- **For a number greater than 1, without any decimal, the trailing zero(s) are not significant.**
- **For a number with a decimal, the trailing zero(s) are significant.**

(5) The digit 0 conventionally put on the left of a decimal for a number less than 1 (like 0.1250) is never significant. However, the zeroes at the end of such number are significant in a measurement.

(6) The multiplying or dividing factors which are neither rounded numbers nor numbers representing measured values are exact and have infinite number of significant digits. For

example in $r = \frac{d}{2}$ or $s = 2\pi r$, the factor 2 is an exact number and it can be written as 2.0, 2.00

or 2.0000 as required. Similarly, in $T = \frac{t}{n}$, n is an exact number.

1.3.1 Rules for Arithmetic Operations with Significant Figures

The result of a calculation involving approximate measured values of quantities (i.e. values with limited number of significant figures) must reflect the uncertainties in the original measured values. It cannot be more accurate than the original measured values themselves on which the result is based. In general, the final result should not have more significant figures than the original data from which it was obtained. Thus, if mass of an object is measured to be, say, 4.237 g (four significant figures) and its volume is measured to be 2.51 cm³, then its density, by mere arithmetic division, is 1.68804780876 g/cm³ upto 11 decimal places. It would be clearly absurd and irrelevant to record the calculated value of density to such a precision when the measurements on which the value is based, have much less precision. The following rules for arithmetic operations with significant figures ensure that the final result of a calculation is shown with the precision that is consistent with the precision of the input measured values :

(1) **In multiplication or division, the final result should retain as many significant figures as are there in the original number with the least significant figures.**

Thus, in the example above, density should be reported to *three* significant figures.

$$\text{Density} = \frac{4.237 \text{ g}}{2.51 \text{ cm}^3} = 1.69 \text{ g cm}^{-3}$$

Similarly, if the speed of light is given as $3.00 \times 10^8 \text{ m s}^{-1}$ (three significant figure) and one year (1y = 365.25 d) has $3.1557 \times 10^7 \text{ s}$ (*five* significant figures), the light year is $9.47 \times 10^{15} \text{ m}$ (*three* significant figures).

(2) **In addition or subtraction, the final result should retain as many decimal places as are there in the number with the least decimal places.**

For example, the sum of the numbers 436.32 g, 227.2 g and 0.301 g by mere arithmetic addition, is 663.821 g. But the least precise measurement (227.2 g) is correct to only one

decimal place. The final result should, therefore, be rounded off to 663.8 g.

Similarly, the difference in length can be expressed as :

$$0.307 \text{ m} - 0.304 \text{ m} = 0.003 \text{ m} = 3 \times 10^{-3} \text{ m}.$$

Note that we should not use the *rule*(1) applicable for multiplication and division and write 664 g as the result in the example of **addition** and $3.00 \times 10^{-3} \text{ m}$ in the example of **subtraction**. They do not convey the precision of measurement properly. For addition and subtraction, the rule is in terms of decimal places.

1.3.2 Rounding off the Uncertain Digits

The result of computation with approximate numbers, which contain more than one uncertain digit, should be rounded off. The rules for rounding off numbers to the appropriate significant figures are obvious in most cases. A number 2.746 rounded off to three significant figures is 1.75, while the number 1.743 would be 1.74. The *rule* by convention is that the **preceding digit is raised by 1 if the insignificant digit to be dropped (the underlined digit in this case) is more than 5, and is left unchanged if the latter is less than 5.** But what if the number is 2.745 in which the insignificant digit is 5. Here, the convention is that **if the preceding digit is even, the insignificant digit is simply dropped and, if it is odd, the preceding digit is raised by 1.** Then, the number 2.745 rounded off to three significant figures becomes 1.74. On the other hand, the number 2.735 rounded off to three significant figures becomes 1.74 since the preceding digit is odd.

In any involved or complex multi-step calculation, you should retain, in intermediate steps, one digit more than the significant digits and round off to proper significant figures at the end of the calculation. Similarly, a number known to be within many significant figures, such as in $1.99792458 \times 10^8 \text{ m/s}$ for the speed of light in vacuum, is rounded off to an approximate value $3 \times 10^8 \text{ m/s}$, which is often employed in computations. Finally, remember that exact numbers that appear in formulae like

$$2\pi \text{ in } T = 2\pi \sqrt{\frac{L}{g}}, \text{ have a large (infinite) number}$$

of significant figures. The value of $\pi = 3.1415926\dots$ is known to a large number of significant figures. You may take the value as 3.142 or 3.14 for π , with limited number of significant figures as required in specific cases.

► **Example 1.1** Each side of a cube is measured to be 7.203 m. What are the total surface area and the volume of the cube to appropriate significant figures?

Answer The number of significant figures in the measured length is 4. The calculated area and the volume should therefore be rounded off to 4 significant figures.

$$\begin{aligned} \text{Surface area of the cube} &= 6(7.203)^2 \text{ m}^2 \\ &= 311.299254 \text{ m}^2 \\ &= 311.3 \text{ m}^2 \\ \text{Volume of the cube} &= (7.203)^3 \text{ m}^3 \\ &= 373.714754 \text{ m}^3 \\ &= 373.7 \text{ m}^3 \end{aligned}$$

► **Example 1.2** 5.74 g of a substance occupies 1.2 cm³. Express its density by keeping the significant figures in view.

Answer There are 3 significant figures in the measured mass whereas there are only 2 significant figures in the measured volume. Hence the density should be expressed to only 2 significant figures.

$$\begin{aligned} \text{Density} &= \frac{5.74}{1.2} \text{ g cm}^{-3} \\ &= 4.8 \text{ g cm}^{-3}. \end{aligned}$$

1.3.3 Rules for Determining the Uncertainty in the Results of Arithmetic Calculations

The rules for determining the uncertainty or error in the number/measured quantity in arithmetic operations can be understood from the following examples.

(1) If the length and breadth of a thin rectangular sheet are measured, using a metre scale as 16.2 cm and, 10.1 cm respectively, there are three significant figures in each measurement. It means that the length l may be written as

$$l = 16.2 \pm 0.1 \text{ cm}$$

$$= 16.2 \text{ cm} \pm 0.6 \%$$

Similarly, the breadth b may be written as

$$\begin{aligned} b &= 10.1 \pm 0.1 \text{ cm} \\ &= 10.1 \text{ cm} \pm 1 \% \end{aligned}$$

Then, the error of the product of two (or more) experimental values, using the combination of errors rule, will be

$$\begin{aligned} lb &= 163.62 \text{ cm}^2 \pm 1.6\% \\ &= 163.62 \pm 2.6 \text{ cm}^2 \end{aligned}$$

This leads us to quote the final result as

$$lb = 164 \pm 3 \text{ cm}^2$$

Here 3 cm² is the uncertainty or error in the estimation of area of rectangular sheet.

(2) If a set of experimental data is specified to n significant figures, a result obtained by combining the data will also be valid to n significant figures.

However, if data are subtracted, the number of significant figures can be reduced.

For example, 12.9 g – 7.06 g, both specified to three significant figures, cannot properly be evaluated as 5.84 g but only as 5.8 g, as uncertainties in subtraction or addition combine in a different fashion (smallest number of decimal places rather than the number of significant figures in any of the number added or subtracted).

(3) The relative error of a value of number specified to significant figures depends not only on n but also on the number itself.

For example, the accuracy in measurement of mass 1.02 g is ± 0.01 g whereas another measurement 9.89 g is also accurate to ± 0.01 g. The relative error in 1.02 g is

$$\begin{aligned} &= (\pm 0.01/1.02) \times 100 \% \\ &= \pm 1\% \end{aligned}$$

Similarly, the relative error in 9.89 g is

$$\begin{aligned} &= (\pm 0.01/9.89) \times 100 \% \\ &= \pm 0.1 \% \end{aligned}$$

Finally, remember that **intermediate results in a multi-step computation should be calculated to one more significant figure in every measurement than the number of digits in the least precise measurement.** These should be justified by the data and then the arithmetic operations may be carried out;

otherwise rounding errors can build up. For example, the reciprocal of 9.58, calculated (after rounding off) to the same number of significant figures (three) is 0.104, but the reciprocal of 0.104 calculated to three significant figures is 9.62. However, if we had written $1/9.58 = 0.1044$ and then taken the reciprocal to three significant figures, we would have retrieved the original value of 9.58.

This example justifies the idea to retain one more extra digit (than the number of digits in the least precise measurement) in intermediate steps of the complex multi-step calculations in order to avoid additional errors in the process of rounding off the numbers.

1.4 DIMENSIONS OF PHYSICAL QUANTITIES

The nature of a physical quantity is described by its dimensions. All the physical quantities represented by derived units can be expressed in terms of some combination of seven fundamental or base quantities. We shall call these base quantities as the seven dimensions of the physical world, which are denoted with square brackets []. Thus, length has the dimension [L], mass [M], time [T], electric current [A], thermodynamic temperature [K], luminous intensity [cd], and amount of substance [mol]. **The dimensions of a physical quantity are the powers (or exponents) to which the base quantities are raised to represent that quantity.** Note that using the square brackets [] round a quantity means that we are dealing with 'the dimensions of' the quantity.

In mechanics, all the physical quantities can be written in terms of the dimensions [L], [M] and [T]. For example, the volume occupied by an object is expressed as the product of length, breadth and height, or three lengths. Hence the dimensions of volume are $[L] \times [L] \times [L] = [L]^3 = [L^3]$. As the volume is independent of mass and time, it is said to possess zero dimension in mass $[M^0]$, zero dimension in time $[T^0]$ and three dimensions in length.

Similarly, force, as the product of mass and acceleration, can be expressed as

$$\begin{aligned} \text{Force} &= \text{mass} \times \text{acceleration} \\ &= \text{mass} \times (\text{length})/(\text{time})^2 \end{aligned}$$

The dimensions of force are $[M] [L]/[T]^2 = [M L T^{-2}]$. Thus, the force has one dimension in

mass, one dimension in length, and -2 dimensions in time. The dimensions in all other base quantities are zero.

Note that in this type of representation, the magnitudes are not considered. It is the quality of the type of the physical quantity that enters. Thus, a change in velocity, initial velocity, average velocity, final velocity, and speed are all equivalent in this context. Since all these quantities can be expressed as length/time, their dimensions are $[L]/[T]$ or $[L T^{-1}]$.

1.5 DIMENSIONAL FORMULAE AND DIMENSIONAL EQUATIONS

The expression which shows how and which of the base quantities represent the dimensions of a physical quantity is called the *dimensional formula* of the given physical quantity. For example, the dimensional formula of the volume is $[M^0 L^3 T^0]$, and that of speed or velocity is $[M^0 L T^{-1}]$. Similarly, $[M^0 L T^{-2}]$ is the dimensional formula of acceleration and $[M L^{-3} T^0]$ that of mass density.

An equation obtained by equating a physical quantity with its dimensional formula is called the **dimensional equation** of the physical quantity. Thus, the dimensional equations are the equations, which represent the dimensions of a physical quantity in terms of the base quantities. For example, the dimensional equations of volume [V], speed [v], force [F] and mass density [ρ] may be expressed as

$$\begin{aligned} [V] &= [M^0 L^3 T^0] \\ [v] &= [M^0 L T^{-1}] \\ [F] &= [M L T^{-2}] \\ [\rho] &= [M L^{-3} T^0] \end{aligned}$$

The dimensional equation can be obtained from the equation representing the relations between the physical quantities. The dimensional formulae of a large number and wide variety of physical quantities, derived from the equations representing the relationships among other physical quantities and expressed in terms of base quantities are given in Appendix 9 for your guidance and ready reference.

1.6 DIMENSIONAL ANALYSIS AND ITS APPLICATIONS

The recognition of concepts of dimensions, which guide the description of physical behaviour is of basic importance as only those physical

quantities can be added or subtracted which have the same dimensions. A thorough understanding of dimensional analysis helps us in deducing certain relations among different physical quantities and checking the derivation, accuracy and dimensional consistency or homogeneity of various mathematical expressions. When magnitudes of two or more physical quantities are multiplied, their units should be treated in the same manner as ordinary algebraic symbols. We can cancel identical units in the numerator and denominator. The same is true for dimensions of a physical quantity. Similarly, physical quantities represented by symbols on both sides of a mathematical equation must have the same dimensions.

1.6.1 Checking the Dimensional Consistency of Equations

The magnitudes of physical quantities may be added together or subtracted from one another only if they have the same dimensions. In other words, we can add or subtract similar physical quantities. Thus, velocity cannot be added to force, or an electric current cannot be subtracted from the thermodynamic temperature. This simple principle called **the principle of homogeneity of dimensions** in an equation is extremely useful in checking the correctness of an equation. If the dimensions of all the terms are not same, the equation is wrong. Hence, if we derive an expression for the length (or distance) of an object, regardless of the symbols appearing in the original mathematical relation, when all the individual dimensions are simplified, the remaining dimension must be that of length. Similarly, if we derive an equation of speed, the dimensions on both the sides of equation, when simplified, must be of length/time, or $[L T^{-1}]$.

Dimensions are customarily used as a preliminary test of the consistency of an equation, when there is some doubt about the correctness of the equation. However, the dimensional consistency does not guarantee correct equations. It is uncertain to the extent of dimensionless quantities or functions. The arguments of special functions, such as the trigonometric, logarithmic and exponential functions must be dimensionless. A pure number, ratio of similar physical quantities,

such as angle as the ratio (length/length), refractive index as the ratio (speed of light in vacuum/speed of light in medium) etc., has no dimensions.

Now we can test the dimensional consistency or homogeneity of the equation

$$x = x_0 + v_0 t + (1/2) a t^2$$

for the distance x travelled by a particle or body in time t which starts from the position x_0 with an initial velocity v_0 at time $t = 0$ and has uniform acceleration a along the direction of motion.

The dimensions of each term may be written as

$$\begin{aligned} [x] &= [L] \\ [x_0] &= [L] \\ [v_0 t] &= [L T^{-1}] [T] \\ &= [L] \\ [(1/2) a t^2] &= [L T^{-2}] [T^2] \\ &= [L] \end{aligned}$$

As each term on the right hand side of this equation has the same dimension, namely that of length, which is same as the dimension of left hand side of the equation, hence this equation is a dimensionally correct equation.

It may be noted that a test of consistency of dimensions tells us no more and no less than a test of consistency of units, but has the advantage that we need not commit ourselves to a particular choice of units, and we need not worry about conversions among multiples and sub-multiples of the units. It may be borne in mind that **if an equation fails this consistency test, it is proved wrong, but if it passes, it is not proved right. Thus, a dimensionally correct equation need not be actually an exact (correct) equation, but a dimensionally wrong (incorrect) or inconsistent equation must be wrong.**

► **Example 1.3** Let us consider an equation

$$\frac{1}{2} m v^2 = m g h$$

where m is the mass of the body, v its velocity, g is the acceleration due to gravity and h is the height. Check whether this equation is dimensionally correct.

Answer The dimensions of LHS are

$$\begin{aligned} [M] [L T^{-1}]^2 &= [M] [L^2 T^{-2}] \\ &= [M L^2 T^{-2}] \end{aligned}$$

The dimensions of RHS are

$$[M][L T^{-2}] [L] = [M][L^2 T^{-2}] \\ = [M L^2 T^{-2}]$$

The dimensions of LHS and RHS are the same and hence the equation is dimensionally correct. ◀

▶ **Example 1.4** The SI unit of energy is $J = \text{kg m}^2 \text{s}^{-2}$; that of speed v is m s^{-1} and of acceleration a is m s^{-2} . Which of the formulae for kinetic energy (K) given below can you rule out on the basis of dimensional arguments (m stands for the mass of the body) :

- (a) $K = m^2 v^3$
- (b) $K = (1/2)mv^2$
- (c) $K = ma$
- (d) $K = (3/16)mv^2$
- (e) $K = (1/2)mv^2 + ma$

Answer Every correct formula or equation must have the same dimensions on both sides of the equation. Also, only quantities with the same physical dimensions can be added or subtracted. The dimensions of the quantity on the right side are $[M^2 L^3 T^{-3}]$ for (a); $[M L^2 T^{-2}]$ for (b) and (d); $[M L T^{-2}]$ for (c). The quantity on the right side of (e) has no proper dimensions since two quantities of different dimensions have been added. Since the kinetic energy K has the dimensions of $[M L^2 T^{-2}]$, formulas (a), (c) and (e) are ruled out. Note that dimensional arguments cannot tell which of the two, (b) or (d), is the correct formula. For this, one must turn to the actual definition of kinetic energy (see Chapter 5). The correct formula for kinetic energy is given by (b). ▶

1.6.2 Deducing Relation among the Physical Quantities

The method of dimensions can sometimes be used to deduce relation among the physical quantities. For this we should know the dependence of the physical quantity on other quantities (upto three physical quantities or linearly independent variables) and consider it as a product type of the dependence. Let us take an example.

▶ **Example 1.5** Consider a simple pendulum, having a bob attached to a

string, that oscillates under the action of the force of gravity. Suppose that the period of oscillation of the simple pendulum depends on its length (l), mass of the bob (m) and acceleration due to gravity (g). Derive the expression for its time period using method of dimensions.

Answer The dependence of time period T on the quantities l , g and m as a product may be written as :

$$T = k l^x g^y m^z$$

where k is dimensionless constant and x , y and z are the exponents.

By considering dimensions on both sides, we have

$$[L^0 M^0 T^1] = [L^1]^x [L^1 T^{-2}]^y [M^1]^z \\ = L^{x+y} T^{-2y} M^z$$

On equating the dimensions on both sides, we have

$$x + y = 0; -2y = 1; \text{ and } z = 0$$

$$\text{So that } x = \frac{1}{2}, y = -\frac{1}{2}, z = 0$$

$$\text{Then, } T = k l^{1/2} g^{-1/2}$$

$$\text{or, } T = k \sqrt{\frac{l}{g}}$$

Note that value of constant k can not be obtained by the method of dimensions. Here it does not matter if some number multiplies the right side of this formula, because that does not affect its dimensions.

$$\text{Actually, } k = 2\pi \text{ so that } T = 2\pi \sqrt{\frac{l}{g}} \quad \blacktriangleleft$$

Dimensional analysis is very useful in deducing relations among the interdependent physical quantities. However, dimensionless constants cannot be obtained by this method. The method of dimensions can only test the dimensional validity, but not the exact relationship between physical quantities in any equation. It does not distinguish between the physical quantities having same dimensions.

A number of exercises at the end of this chapter will help you develop skill in dimensional analysis.

SUMMARY

1. Physics is a quantitative science, based on measurement of physical quantities. Certain physical quantities have been chosen as fundamental or base quantities (such as length, mass, time, electric current, thermodynamic temperature, amount of substance, and luminous intensity).
2. Each base quantity is defined in terms of a certain basic, arbitrarily chosen but properly standardised reference standard called unit (such as metre, kilogram, second, ampere, kelvin, mole and candela). The units for the fundamental or base quantities are called fundamental or base units.
3. Other physical quantities, derived from the base quantities, can be expressed as a combination of the base units and are called derived units. A complete set of units, both fundamental and derived, is called a system of units.
4. The International System of Units (SI) based on seven base units is at present internationally accepted unit system and is widely used throughout the world.
5. The SI units are used in all physical measurements, for both the base quantities and the derived quantities obtained from them. Certain derived units are expressed by means of SI units with special names (such as joule, newton, watt, etc).
6. The SI units have well defined and internationally accepted unit symbols (such as m for metre, kg for kilogram, s for second, A for ampere, N for newton etc.).
7. Physical measurements are usually expressed for small and large quantities in scientific notation, with powers of 10. Scientific notation and the prefixes are used to simplify measurement notation and numerical computation, giving indication to the precision of the numbers.
8. Certain general rules and guidelines must be followed for using notations for physical quantities and standard symbols for SI units, some other units and SI prefixes for expressing properly the physical quantities and measurements.
9. In computing any physical quantity, the units for derived quantities involved in the relationship(s) are treated as though they were algebraic quantities till the desired units are obtained.
10. In measured and computed quantities proper significant figures only should be retained. Rules for determining the number of significant figures, carrying out arithmetic operations with them, and 'rounding off' the uncertain digits must be followed.
11. The dimensions of base quantities and combination of these dimensions describe the nature of physical quantities. Dimensional analysis can be used to check the dimensional consistency of equations, deducing relations among the physical quantities, etc. A dimensionally consistent equation need not be actually an exact (correct) equation, but a dimensionally wrong or inconsistent equation must be wrong.

EXERCISES

Note : In stating numerical answers, take care of significant figures.

- 1.1** Fill in the blanks
- (a) The volume of a cube of side 1 cm is equal tom³
 - (b) The surface area of a solid cylinder of radius 2.0 cm and height 10.0 cm is equal to ... (mm)²
 - (c) A vehicle moving with a speed of 18 km h⁻¹ covers....m in 1 s
 - (d) The relative density of lead is 11.3. Its density isg cm⁻³ orkg m⁻³.
- 1.2** Fill in the blanks by suitable conversion of units
- (a) 1 kg m² s⁻² =g cm² s⁻²
 - (b) 1 m = ly
 - (c) 3.0 m s⁻² = km h⁻²
 - (d) $G = 6.67 \times 10^{-11} \text{ N m}^2 (\text{kg})^{-2} = \dots (\text{cm})^3 \text{ s}^{-2} \text{ g}^{-1}$.

- 1.3** A calorie is a unit of heat (energy in transit) and it equals about 4.2 J where $1\text{J} = 1\text{ kg m}^2\text{ s}^{-2}$. Suppose we employ a system of units in which the unit of mass equals α kg, the unit of length equals β m, the unit of time is γ s. Show that a calorie has a magnitude $4.2 \alpha^{-1} \beta^{-2} \gamma^2$ in terms of the new units.
- 1.4** Explain this statement clearly :
 "To call a dimensional quantity 'large' or 'small' is meaningless without specifying a standard for comparison". In view of this, reframe the following statements wherever necessary :
- atoms are very small objects
 - a jet plane moves with great speed
 - the mass of Jupiter is very large
 - the air inside this room contains a large number of molecules
 - a proton is much more massive than an electron
 - the speed of sound is much smaller than the speed of light.
- 1.5** A new unit of length is chosen such that the speed of light in vacuum is unity. What is the distance between the Sun and the Earth in terms of the new unit if light takes 8 min and 20 s to cover this distance ?
- 1.6** Which of the following is the most precise device for measuring length :
 (a) a vernier callipers with 20 divisions on the sliding scale
 (b) a screw gauge of pitch 1 mm and 100 divisions on the circular scale
 (c) an optical instrument that can measure length to within a wavelength of light ?
- 1.7** A student measures the thickness of a human hair by looking at it through a microscope of magnification 100. He makes 20 observations and finds that the average width of the hair in the field of view of the microscope is 3.5 mm. What is the estimate on the thickness of hair ?
- 1.8** Answer the following :
 (a) You are given a thread and a metre scale. How will you estimate the diameter of the thread ?
 (b) A screw gauge has a pitch of 1.0 mm and 200 divisions on the circular scale. Do you think it is possible to increase the accuracy of the screw gauge arbitrarily by increasing the number of divisions on the circular scale ?
 (c) The mean diameter of a thin brass rod is to be measured by vernier callipers. Why is a set of 100 measurements of the diameter expected to yield a more reliable estimate than a set of 5 measurements only ?
- 1.9** The photograph of a house occupies an area of 1.75 cm^2 on a 35 mm slide. The slide is projected on to a screen, and the area of the house on the screen is 1.55 m^2 . What is the linear magnification of the projector-screen arrangement.
- 1.10** State the number of significant figures in the following :
 (a) 0.007 m^2
 (b) $2.64 \times 10^{24}\text{ kg}$
 (c) 0.2370 g cm^{-3}
 (d) 6.320 J
 (e) 6.032 N m^{-2}
 (f) 0.0006032 m^2
- 1.11** The length, breadth and thickness of a rectangular sheet of metal are 4.234 m, 1.005 m, and 2.01 cm respectively. Give the area and volume of the sheet to correct significant figures.
- 1.12** The mass of a box measured by a grocer's balance is 2.30 kg. Two gold pieces of masses 20.15 g and 20.17 g are added to the box. What is (a) the total mass of the box, (b) the difference in the masses of the pieces to correct significant figures ?
- 1.13** A famous relation in physics relates 'moving mass' m to the 'rest mass' m_0 of a particle in terms of its speed v and the speed of light, c . (This relation first arose as a consequence of special relativity due to Albert Einstein). A boy recalls the relation almost correctly but forgets where to put the constant c . He writes :

$$m = \frac{m_0}{(1 - v^2)^{1/2}}$$

Guess where to put the missing c .

- 1.14 The unit of length convenient on the atomic scale is known as an angstrom and is denoted by Å: $1 \text{ \AA} = 10^{-10} \text{ m}$. The size of a hydrogen atom is about 0.5 \AA . What is the total atomic volume in m^3 of a mole of hydrogen atoms ?
- 1.15 One mole of an ideal gas at standard temperature and pressure occupies 22.4 L (molar volume). What is the ratio of molar volume to the atomic volume of a mole of hydrogen ? (Take the size of hydrogen molecule to be about 1 \AA). Why is this ratio so large ?
- 1.16 Explain this common observation clearly : If you look out of the window of a fast moving train, the nearby trees, houses etc. seem to move rapidly in a direction opposite to the train's motion, but the distant objects (hill tops, the Moon, the stars etc.) seem to be stationary. (In fact, since you are aware that you are moving, these distant objects seem to move with you).
- 1.17 The Sun is a hot plasma (ionized matter) with its inner core at a temperature exceeding 10^7 K , and its outer surface at a temperature of about 6000 K . At these high temperatures, no substance remains in a solid or liquid phase. In what range do you expect the mass density of the Sun to be, in the range of densities of solids and liquids or gases ? Check if your guess is correct from the following data : mass of the Sun = $2.0 \times 10^{30} \text{ kg}$, radius of the Sun = $7.0 \times 10^8 \text{ m}$.

© NCERT
not to be republished



MOTION IN A STRAIGHT LINE

- 2.1 Introduction
 - 2.2 Instantaneous velocity and speed
 - 2.3 Acceleration
 - 2.4 Kinematic equations for uniformly accelerated motion
 - 2.5 Relative velocity
- Summary
Points to ponder
Exercises

2.1 INTRODUCTION

Motion is common to everything in the universe. We walk, run and ride a bicycle. Even when we are sleeping, air moves into and out of our lungs and blood flows in arteries and veins. We see leaves falling from trees and water flowing down a dam. Automobiles and planes carry people from one place to the other. The earth rotates once every twenty-four hours and revolves round the sun once in a year. The sun itself is in motion in the Milky Way, which is again moving within its local group of galaxies.

Motion is change in position of an object with time. How does the position change with time? In this chapter, we shall learn how to describe motion. For this, we develop the concepts of velocity and acceleration. We shall confine ourselves to the study of motion of objects along a straight line, also known as **rectilinear motion**. For the case of rectilinear motion with uniform acceleration, a set of simple equations can be obtained. Finally, to understand the relative nature of motion, we introduce the concept of relative velocity.

In our discussions, we shall treat the objects in motion as point objects. This approximation is valid so far as the size of the object is much smaller than the distance it moves in a reasonable duration of time. In a good number of situations in real-life, the size of objects can be neglected and they can be considered as point-like objects without much error.

In **Kinematics**, we study ways to describe motion without going into the causes of motion. What causes motion described in this chapter and the next chapter forms the subject matter of Chapter 4.

2.2 INSTANTANEOUS VELOCITY AND SPEED

The average velocity tells us how fast an object has been moving over a given time interval but does not tell us how fast it moves at different instants of time during that interval. For this, we define **instantaneous velocity** or simply velocity v at an instant t .

The velocity at an instant is defined as the limit of the average velocity as the time interval Δt becomes infinitesimally small. In other words,

$$v = \lim_{\Delta t \rightarrow 0} \frac{\Delta x}{\Delta t} \quad (2.1a)$$

$$= \frac{dx}{dt} \quad (2.1b)$$

where the symbol $\lim_{\Delta t \rightarrow 0}$ stands for the operation of taking limit as $\Delta t \rightarrow 0$ of the quantity on its right. In the language of calculus, the quantity on the right hand side of Eq. (2.1a) is the differential coefficient of x with respect to t and is denoted by $\frac{dx}{dt}$ (see Appendix 2.1). It is the rate of change of position with respect to time, at that instant.

We can use Eq. (2.1a) for obtaining the value of velocity at an instant either **graphically** or **numerically**. Suppose that we want to obtain graphically the value of velocity at time $t = 4$ s (point P) for the motion of the car represented in Fig. 2.1 calculation. Let us take $\Delta t = 2$ s centred at $t = 4$ s. Then, by the definition of the average velocity, the slope of line P_1P_2 (Fig. 2.1) gives the value of average velocity over the interval 3 s to 5 s.

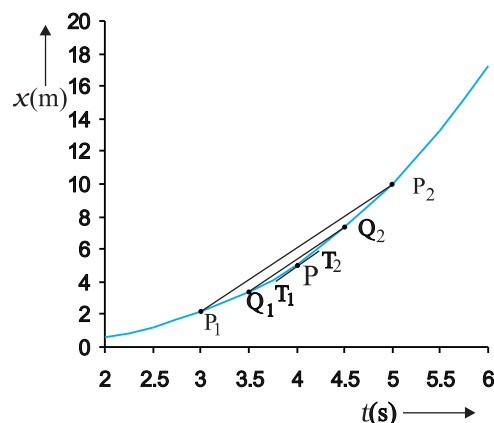

Fig. 2.1 Determining velocity from position-time graph. Velocity at $t = 4$ s is the slope of the tangent to the graph at that instant.

Now, we decrease the value of Δt from 2 s to 1 s. Then line P_1P_2 becomes Q_1Q_2 and its slope gives the value of the average velocity over the interval 3.5 s to 4.5 s. In the limit $\Delta t \rightarrow 0$, the line P_1P_2 becomes tangent to the position-time curve at the point P and the velocity at $t = 4$ s is given by the slope of the tangent at that point. **It is difficult to show this process graphically. But if we use numerical method to obtain the value of the velocity, the meaning of the limiting process becomes clear.** For the graph shown in Fig. 2.1, $x = 0.08 t^3$. Table 2.1 gives the value of $\Delta x/\Delta t$ calculated for Δt equal to 2.0 s, 1.0 s, 0.5 s, 0.1 s and 0.01 s centred at $t = 4.0$ s. The second and third columns give the value of $t_1 = \left(t - \frac{\Delta t}{2} \right)$ and $t_2 = \left(t + \frac{\Delta t}{2} \right)$ and the fourth and the fifth columns give the

Table 2.1 Limiting value of $\frac{\Delta x}{\Delta t}$ at $t = 4$ s

| Δt (s) | t_1 (s) | t_2 (s) | $x(t_1)$ (m) | $x(t_2)$ (m) | Δx (m) | $\Delta x / \Delta t$ (m s ⁻¹) |
|-------------------|--------------|--------------|-----------------|-----------------|-------------------|---|
| 2.0 | 3.0 | 5.0 | 2.16 | 10.0 | 7.84 | 3.92 |
| 1.0 | 3.5 | 4.5 | 3.43 | 7.29 | 3.86 | 3.86 |
| 0.5 | 3.75 | 4.25 | 4.21875 | 6.14125 | 1.9225 | 3.845 |
| 0.1 | 3.95 | 4.05 | 4.93039 | 5.31441 | 0.38402 | 3.8402 |
| 0.01 | 3.995 | 4.005 | 5.100824 | 5.139224 | 0.0384 | 3.8400 |

corresponding values of x , i.e. $x(t_1) = 0.08 t_1^3$ and $x(t_2) = 0.08 t_2^3$. The sixth column lists the difference $\Delta x = x(t_2) - x(t_1)$ and the last column gives the ratio of Δx and Δt , i.e. the average velocity corresponding to the value of Δt listed in the first column.

We see from Table 2.1 that as we decrease the value of Δt from 2.0 s to 0.010 s, the value of the average velocity approaches the limiting value 3.84 m s^{-1} which is the value of velocity at

$t = 4.0 \text{ s}$, i.e. the value of $\frac{dx}{dt}$ at $t = 4.0 \text{ s}$. In this

manner, we can calculate velocity at each instant for motion of the car.

The graphical method for the determination of the instantaneous velocity is always not a convenient method. For this, we must carefully plot the position–time graph and calculate the value of average velocity as Δt becomes smaller and smaller. It is easier to calculate the value of velocity at different instants if we have data of positions at different instants or exact expression for the position as a function of time. Then, we calculate $\Delta x/\Delta t$ from the data for decreasing the value of Δt and find the limiting value as we have done in Table 2.1 or use differential calculus for the given expression and

calculate $\frac{dx}{dt}$ at different instants as done in the following example.

Example 2.1 The position of an object moving along x -axis is given by $x = a + bt^2$ where $a = 8.5 \text{ m}$, $b = 2.5 \text{ m s}^{-2}$ and t is measured in seconds. What is its velocity at $t = 0 \text{ s}$ and $t = 2.0 \text{ s}$. What is the average velocity between $t = 2.0 \text{ s}$ and $t = 4.0 \text{ s}$?

Answer In notation of differential calculus, the velocity is

$$v = \frac{dx}{dt} = \frac{d}{dt}(a + bt^2) = 2bt = 5.0 t \text{ m s}^{-1}$$

At $t = 0 \text{ s}$, $v = 0 \text{ m s}^{-1}$ and at $t = 2.0 \text{ s}$, $v = 10 \text{ m s}^{-1}$.

$$\text{Average velocity} = \frac{x(4.0) - x(2.0)}{4.0 - 2.0}$$

$$= \frac{a + 16b - a - 4b}{2.0} = 6.0 \times b$$

$$= 6.0 \times 2.5 = 15 \text{ m s}^{-1}$$

Note that for uniform motion, velocity is the same as the average velocity at all instants.

Instantaneous speed or simply speed is the magnitude of velocity. For example, a velocity of $+ 24.0 \text{ m s}^{-1}$ and a velocity of $- 24.0 \text{ m s}^{-1}$ — both have an associated speed of 24.0 m s^{-1} . It should be noted that though average speed over a finite interval of time is greater or equal to the magnitude of the average velocity, instantaneous speed at an instant is equal to the magnitude of the instantaneous velocity at that instant. Why so?

2.3 ACCELERATION

The velocity of an object, in general, changes during its course of motion. How to describe this change? Should it be described as the rate of change in velocity **with distance** or **with time**? This was a problem even in Galileo's time. It was first thought that this change could be described by the rate of change of velocity with distance. But, through his studies of motion of freely falling objects and motion of objects on an inclined plane, Galileo concluded that the rate of change of velocity with time is a constant of motion for all objects in free fall. On the other hand, the change in velocity with distance is not constant – it decreases with the increasing distance of fall. This led to the concept of acceleration as the rate of change of velocity with time.

The average acceleration \bar{a} over a time interval is defined as the change of velocity divided by the time interval :

$$\bar{a} = \frac{v_2 - v_1}{t_2 - t_1} = \frac{\Delta v}{\Delta t} \quad (2.2)$$

where v_2 and v_1 are the instantaneous velocities or simply velocities at time t_2 and t_1 . It is the average change of velocity per unit time. The SI unit of acceleration is m s^{-2} .

On a plot of velocity versus time, the average acceleration is the slope of the straight line connecting the points corresponding to (v_2, t_2) and (v_1, t_1) .

Instantaneous acceleration is defined in the same way as the instantaneous velocity :

$$a = \lim_{\Delta t \rightarrow 0} \frac{\Delta v}{\Delta t} = \frac{dv}{dt} \quad (2.3)$$

The acceleration at an instant is the slope of the tangent to the v - t curve at that instant.

Since velocity is a quantity having both magnitude and direction, a change in velocity may involve either or both of these factors. Acceleration, therefore, may result from a change in speed (magnitude), a change in direction or changes in both. Like velocity, acceleration can also be positive, negative or zero. Position-time graphs for motion with positive, negative and zero acceleration are shown in Figs. 2.4 (a), (b) and (c), respectively. Note that the graph curves upward for positive acceleration; downward for negative acceleration and it is a straight line for zero acceleration.

Although acceleration can vary with time, our study in this chapter will be restricted to motion with constant acceleration. In this case, the average acceleration equals the constant value of acceleration during the interval. If the velocity of an object is v_0 at $t = 0$ and v at time t , we have

$$\bar{a} = \frac{v - v_0}{t - 0} \text{ or, } v = v_0 + at \quad (2.4)$$

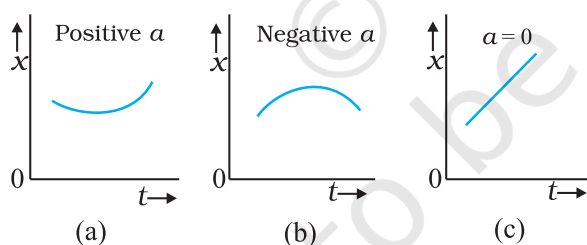

Fig. 2.2 Position-time graph for motion with (a) positive acceleration; (b) negative acceleration, and (c) zero acceleration.

Let us see how velocity-time graph looks like for some simple cases. Fig. 2.3 shows velocity-time graph for motion with constant acceleration for the following cases :

- An object is moving in a positive direction with a positive acceleration.
- An object is moving in positive direction with a negative acceleration.

- An object is moving in negative direction with a negative acceleration.
- An object is moving in positive direction till time t_1 , and then turns back with the same negative acceleration.

An interesting feature of a velocity-time graph for any moving object is that **the area under the curve represents the displacement over a given time interval**. A general proof of this statement requires use of calculus. We can, however, see that it is true for the simple case of an object moving with constant velocity u . Its velocity-time graph is as shown in Fig. 2.4.

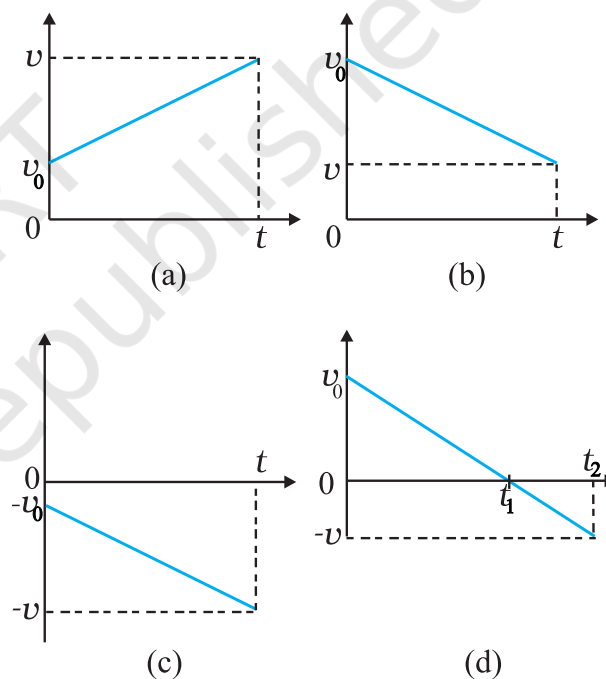

Fig. 2.3 Velocity-time graph for motions with constant acceleration. (a) Motion in positive direction with positive acceleration, (b) Motion in positive direction with negative acceleration, (c) Motion in negative direction with negative acceleration, (d) Motion of an object with negative acceleration that changes direction at time t_1 . Between times 0 to t_1 , it moves in positive x -direction and between t_1 and t_2 it moves in the opposite direction.

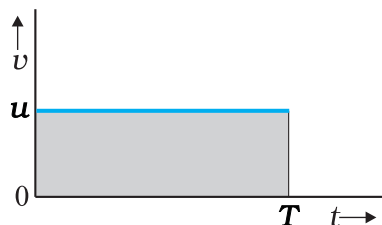

Fig. 2.4 Area under v - t curve equals displacement of the object over a given time interval.

The v - t curve is a straight line parallel to the time axis and the area under it between $t = 0$ and $t = T$ is the area of the rectangle of height u and base T . Therefore, area = $u \times T = uT$ which is the displacement in this time interval. How come in this case an area is equal to a distance? Think! Note the dimensions of quantities on the two coordinate axes, and you will arrive at the answer.

Note that the x - t , v - t , and a - t graphs shown in several figures in this chapter have sharp kinks at some points implying that the functions are not differentiable at these points. In any realistic situation, the functions will be differentiable at all points and the graphs will be smooth.

What this means physically is that acceleration and velocity cannot change values abruptly at an instant. Changes are always continuous.

2.4 KINEMATIC EQUATIONS FOR UNIFORMLY ACCELERATED MOTION

For uniformly accelerated motion, we can derive some simple equations that relate displacement (x), time taken (t), initial velocity (v_0), final velocity (v) and acceleration (a). Equation (2.4) already obtained gives a relation between final and initial velocities v and v_0 of an object moving with uniform acceleration a :

$$v = v_0 + at \quad (2.4)$$

This relation is graphically represented in Fig. 2.5.

The area under this curve is:

Area between instants 0 and $t =$ Area of triangle ABC + Area of rectangle OACD

$$= \frac{1}{2}(v-v_0)t + v_0t$$

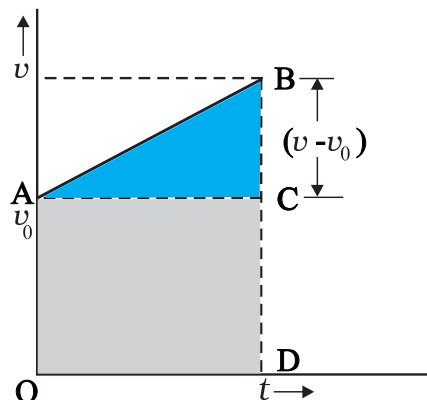

Fig. 2.5 Area under v - t curve for an object with uniform acceleration.

As explained in the previous section, the area under v - t curve represents the displacement. Therefore, the displacement x of the object is:

$$x = \frac{1}{2}(v-v_0)t + v_0t \quad (2.5)$$

But $v - v_0 = at$

Therefore, $x = \frac{1}{2}at^2 + v_0t$

$$\text{or, } x = v_0t + \frac{1}{2}at^2 \quad (2.6)$$

Equation (2.5) can also be written as

$$x = \frac{v+v_0}{2}t = \bar{v}t \quad (2.7a)$$

where,

$$\bar{v} = \frac{v+v_0}{2} \quad \text{(constant acceleration only)} \quad (2.7b)$$

Equations (2.7a) and (2.7b) mean that the object has undergone displacement x with an average velocity equal to the arithmetic average of the initial and final velocities.

From Eq. (2.4), $t = (v - v_0)/a$. Substituting this in Eq. (2.7a), we get

$$x = \bar{v}t = \left(\frac{v+v_0}{2}\right)\left(\frac{v-v_0}{a}\right) = \frac{v^2 - v_0^2}{2a}$$

$$v^2 = v_0^2 + 2ax \quad (2.8)$$

This equation can also be obtained by substituting the value of t from Eq. (2.4) into Eq. (2.6). Thus, we have obtained three important equations :

$$v = v_0 + at$$

$$x = v_0 t + \frac{1}{2} a t^2$$

$$v^2 = v_0^2 + 2ax \quad (2.9a)$$

connecting five quantities v_0 , v , a , t and x . These are kinematic equations of rectilinear motion for constant acceleration.

The set of Eq. (2.9a) were obtained by assuming that at $t = 0$, the position of the particle, x is 0. We can obtain a more general equation if we take the position coordinate at $t = 0$ as non-zero, say x_0 . Then Eqs. (2.9a) are modified (replacing x by $x - x_0$) to :

$$v = v_0 + at$$

$$x = x_0 + v_0 t + \frac{1}{2} a t^2 \quad (2.9b)$$

$$v^2 = v_0^2 + 2a(x - x_0) \quad (2.9c)$$

► **Example 2.2** Obtain equations of motion for constant acceleration using method of calculus.

Answer By definition

$$a = \frac{dv}{dt}$$

$$dv = a dt$$

Integrating both sides

$$\int_{v_0}^v dv = \int_0^t a dt$$

$$= a \int_0^t dt \quad (a \text{ is}$$

constant)

$$v - v_0 = at$$

$$v = v_0 + at$$

Further,

$$v = \frac{dx}{dt}$$

$$dx = v dt$$

Integrating both sides

$$\int_{x_0}^x dx = \int_0^t v dt$$

$$= \int_0^t (v_0 + at) dt$$

$$x - x_0 = v_0 t + \frac{1}{2} a t^2$$

$$x = x_0 + v_0 t + \frac{1}{2} a t^2$$

We can write

$$a = \frac{dv}{dt} = \frac{dv}{dx} \frac{dx}{dt} = v \frac{dv}{dx}$$

$$\text{or, } v dv = a dx$$

Integrating both sides,

$$\int_{v_0}^v v dv = \int_{x_0}^x a dx$$

$$\frac{v^2 - v_0^2}{2} = a(x - x_0)$$

$$v^2 = v_0^2 + 2a(x - x_0)$$

The advantage of this method is that it can be used for motion with non-uniform acceleration also.

Now, we shall use these equations to some important cases. ◀

► **Example 2.3** A ball is thrown vertically upwards with a velocity of 20 m s^{-1} from the top of a multistorey building. The height of the point from where the ball is thrown is 25.0 m from the ground. (a) How high will the ball rise ? and (b) how long will it be before the ball hits the ground? Take $g = 10 \text{ m s}^{-2}$.

Answer (a) Let us take the y -axis in the vertically upward direction with zero at the ground, as shown in Fig. 2.6.

$$\text{Now } v_0 = +20 \text{ m s}^{-1},$$

$$a = -g = -10 \text{ m s}^{-2},$$

$$v = 0 \text{ m s}^{-1}$$

If the ball rises to height y from the point of launch, then using the equation

$$v^2 = v_0^2 + 2 a (y - y_0)$$

we get

$$0 = (20)^2 + 2(-10)(y - y_0)$$

Solving, we get, $(y - y_0) = 20 \text{ m}$.

(b) We can solve this part of the problem in two ways. **Note carefully the methods used.**

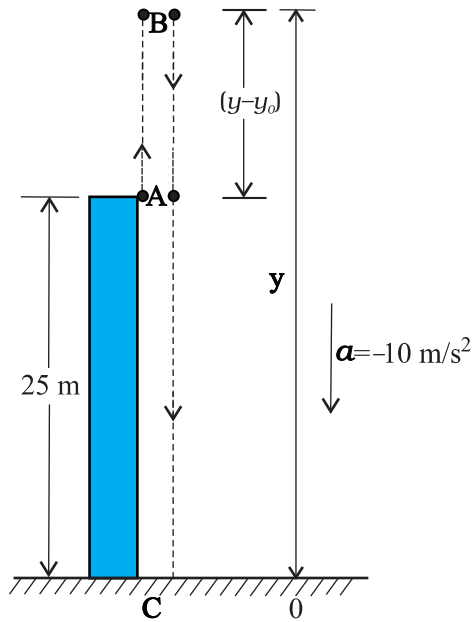

Fig. 2.6

FIRST METHOD : In the first method, we split the path in two parts : the upward motion (A to B) and the downward motion (B to C) and calculate the corresponding time taken t_1 and t_2 . Since the velocity at B is zero, we have :

$$v = v_0 + at$$

$$0 = 20 - 10t_1$$

Or, $t_1 = 2 \text{ s}$

This is the time in going from A to B. From B, or the point of the maximum height, the ball falls freely under the acceleration due to gravity. The ball is moving in negative y direction. We use equation

$$y = y_0 + v_0 t + \frac{1}{2} a t^2$$

We have, $y_0 = 25 \text{ m}$, $y = 0$, $v_0 = 0$, $a = -g = -10 \text{ m s}^{-2}$

$$0 = 25 + (\frac{1}{2}) (-10) t_2^2$$

Solving, we get $t_2 = 3 \text{ s}$

Therefore, the total time taken by the ball before it hits the ground $= t_1 + t_2 = 2 \text{ s} + 3 \text{ s} = 5 \text{ s}$.

SECOND METHOD : The total time taken can also be calculated by noting the coordinates of initial and final positions of the ball with respect to the origin chosen and using equation

$$y = y_0 + v_0 t + \frac{1}{2} a t^2$$

Now $y_0 = 25 \text{ m}$ $y = 0 \text{ m}$
 $v_0 = 20 \text{ m s}^{-1}$, $a = -10 \text{ m s}^{-2}$, $t = ?$

$$0 = 25 + 20 t + (\frac{1}{2}) (-10) t^2$$

Or, $5t^2 - 20t - 25 = 0$

Solving this quadratic equation for t , we get

$$t = 5 \text{ s}$$

Note that the second method is better since we do not have to worry about the path of the motion as the motion is under constant acceleration.

Example 2.4 Free-fall : Discuss the motion of an object under free fall. Neglect air resistance.

Answer An object released near the surface of the Earth is accelerated downward under the influence of the force of gravity. The magnitude of acceleration due to gravity is represented by g . If air resistance is neglected, the object is said to be in **free fall**. If the height through which the object falls is small compared to the earth's radius, g can be taken to be constant, equal to 9.8 m s^{-2} . Free fall is thus a case of motion with uniform acceleration.

We assume that the motion is in y -direction, more correctly in $-y$ -direction because we choose upward direction as positive. Since the acceleration due to gravity is always downward, it is in the negative direction and we have

$$a = -g = -9.8 \text{ m s}^{-2}$$

The object is released from rest at $y = 0$. Therefore, $v_0 = 0$ and the equations of motion become:

$$v = 0 - g t = -9.8 t \quad \text{m s}^{-1}$$

$$y = 0 - \frac{1}{2} g t^2 = -4.9 t^2 \quad \text{m}$$

$$v^2 = 0 - 2 g y = -19.6 y \quad \text{m}^2 \text{ s}^{-2}$$

These equations give the velocity and the distance travelled as a function of time and also the variation of velocity with distance. The variation of acceleration, velocity, and distance, with time have been plotted in Fig. 2.7(a), (b) and (c).

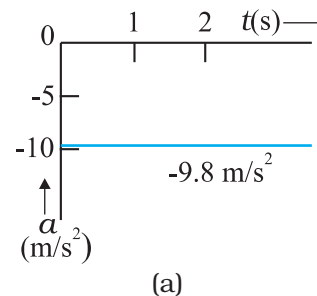

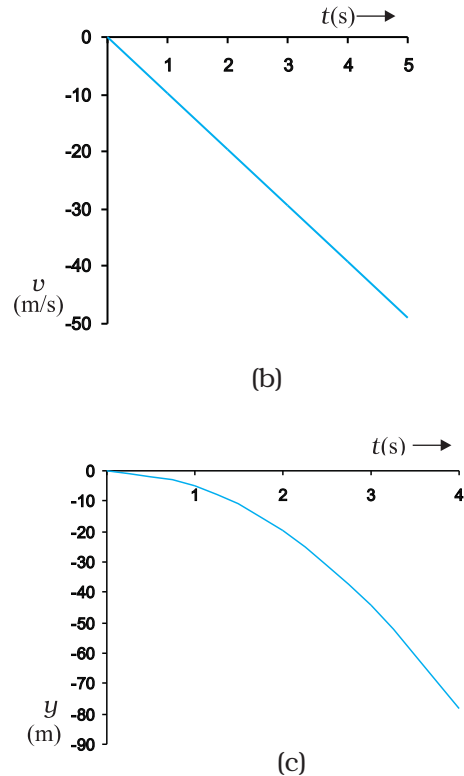

Fig. 2.7 Motion of an object under free fall.
 (a) Variation of acceleration with time.
 (b) Variation of velocity with time.
 (c) Variation of distance with time

► **Example 2.5 Galileo's law of odd numbers** : "The distances traversed, during equal intervals of time, by a body falling from rest, stand to one another in the same ratio as the odd numbers beginning with unity [namely, 1: 3: 5: 7:.....]." Prove it.

Answer Let us divide the time interval of motion of an object under free fall into many equal intervals τ and find out the distances

traversed during successive intervals of time. Since initial velocity is zero, we have

$$y = -\frac{1}{2}gt^2$$

Using this equation, we can calculate the position of the object after different time intervals, $0, \tau, 2\tau, 3\tau, \dots$ which are given in second column of Table 2.2. If we take $(-1/2)g\tau^2$ as y_0 —the position coordinate after first time interval τ , then third column gives the positions in the unit of y_0 . The fourth column gives the distances traversed in successive τ s. We find that the distances are in the simple ratio 1: 3: 5: 7: 9: 11... as shown in the last column. This law was established by Galileo Galilei (1564-1642) who was the first to make quantitative studies of free fall. ◀

► **Example 2.6 Stopping distance of vehicles** : When brakes are applied to a moving vehicle, the distance it travels before stopping is called stopping distance. It is an important factor for road safety and depends on the initial velocity (v_0) and the braking capacity, or deceleration, $-a$ that is caused by the braking. Derive an expression for stopping distance of a vehicle in terms of v_0 and a .

Answer Let the distance travelled by the vehicle before it stops be d_s . Then, using equation of motion $v^2 = v_0^2 + 2ax$, and noting that $v = 0$, we have the stopping distance

$$d_s = \frac{-v_0^2}{2a}$$

Thus, the stopping distance is proportional to the square of the initial velocity. Doubling the

Table 2.2

| t | y | y in terms of y_0 [$=(-1/2)g\tau^2$] | Distance traversed in successive intervals | Ratio of distances traversed |
|---------|-------------------|--|--|------------------------------|
| 0 | 0 | 0 | | |
| τ | $-(1/2)g\tau^2$ | y_0 | y_0 | 1 |
| 2τ | $-4(1/2)g\tau^2$ | $4y_0$ | $3y_0$ | 3 |
| 3τ | $-9(1/2)g\tau^2$ | $9y_0$ | $5y_0$ | 5 |
| 4τ | $-16(1/2)g\tau^2$ | $16y_0$ | $7y_0$ | 7 |
| 5τ | $-25(1/2)g\tau^2$ | $25y_0$ | $9y_0$ | 9 |
| 6τ | $-36(1/2)g\tau^2$ | $36y_0$ | $11y_0$ | 11 |

initial velocity increases the stopping distance by a factor of 4 (for the same deceleration).

For the car of a particular make, the braking distance was found to be 10 m, 20 m, 34 m and 50 m corresponding to velocities of 11, 15, 20 and 25 m/s which are nearly consistent with the above formula.

Stopping distance is an important factor considered in setting speed limits, for example, in school zones. ◀

▶ **Example 2.7 Reaction time :** When a situation demands our immediate action, it takes some time before we really respond. Reaction time is the time a person takes to observe, think and act. For example, if a person is driving and suddenly a boy appears on the road, then the time elapsed before he slams the brakes of the car is the reaction time. Reaction time depends on complexity of the situation and on an individual.

You can measure your reaction time by a simple experiment. Take a ruler and ask your friend to drop it vertically through the gap between your thumb and forefinger (Fig. 2.8). After you catch it, find the distance d travelled by the ruler. In a particular case, d was found to be 21.0 cm. Estimate reaction time.

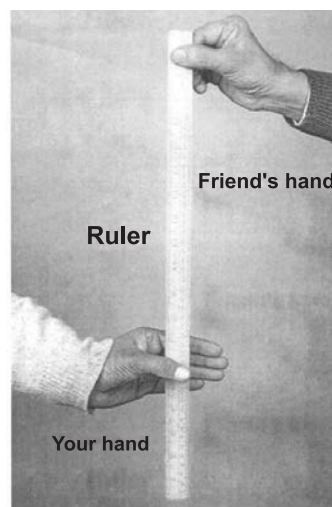

Fig. 2.8 Measuring the reaction time.

Answer The ruler drops under free fall. Therefore, $v_o = 0$, and $a = -g = -9.8 \text{ m s}^{-2}$. The distance travelled d and the reaction time t_r are related by

$$d = -\frac{1}{2}gt_r^2$$

Or,
$$t_r = \sqrt{\frac{2d}{g}} \text{ s}$$

Given $d = 21.0 \text{ cm}$ and $g = 9.8 \text{ m s}^{-2}$ the reaction time is

$$t_r = \sqrt{\frac{2 \times 0.21}{9.8}} \text{ s} \approx 0.2 \text{ s.} \quad \blacktriangleleft$$

SUMMARY

1. An object is said to be in *motion* if its position changes with time. The position of the object can be specified with reference to a conveniently chosen origin. For motion in a straight line, position to the right of the origin is taken as positive and to the left as negative.

The average speed of an object is greater or equal to the magnitude of the average velocity over a given time interval.

2. *Instantaneous velocity* or simply velocity is defined as the limit of the average velocity as the time interval Δt becomes infinitesimally small :

$$v = \lim_{\Delta t \rightarrow 0} \bar{v} = \lim_{\Delta t \rightarrow 0} \frac{\Delta x}{\Delta t} = \frac{dx}{dt}$$

The velocity at a particular instant is equal to the slope of the tangent drawn on position-time graph at that instant.

3. *Average acceleration* is the change in velocity divided by the time interval during which the change occurs :

$$\bar{a} = \frac{\Delta v}{\Delta t}$$

4. *Instantaneous acceleration* is defined as the limit of the average acceleration as the time interval Δt goes to zero :

$$a = \lim_{\Delta t \rightarrow 0} \bar{a} = \lim_{\Delta t \rightarrow 0} \frac{\Delta v}{\Delta t} = \frac{dv}{dt}$$

The acceleration of an object at a particular time is the slope of the velocity-time graph at that instant of time. For uniform motion, acceleration is zero and the $x-t$ graph is a straight line inclined to the time axis and the $v-t$ graph is a straight line parallel to the time axis. For motion with uniform acceleration, $x-t$ graph is a parabola while the $v-t$ graph is a straight line inclined to the time axis.

5. The area under the velocity-time curve between times t_1 and t_2 is equal to the displacement of the object during that interval of time.
6. For objects in uniformly accelerated rectilinear motion, the five quantities, displacement x , time taken t , initial velocity v_0 , final velocity v and acceleration a are related by a set of simple equations called *kinematic equations of motion* :

$$v = v_0 + at$$

$$x = v_0 t + \frac{1}{2} at^2$$

$$v^2 = v_0^2 + 2ax$$

if the position of the object at time $t = 0$ is 0. If the particle starts at $x = x_0$, x in above equations is replaced by $(x - x_0)$.

| Physical quantity | Symbol | Dimensions | Unit | Remarks |
|-------------------|------------|---------------------|-------------------|--|
| Path length | | [L] | m | |
| Displacement | Δx | [L] | m | $= x_2 - x_1$ In one dimension, its sign indicates the direction. |
| Velocity | | [LT ⁻¹] | m s ⁻¹ | |
| (a) Average | \bar{v} | | | $= \frac{\Delta x}{\Delta t}$ |
| (b) Instantaneous | v | | | $= \lim_{\Delta t \rightarrow 0} \frac{\Delta x}{\Delta t} = \frac{dx}{dt}$ In one dimension, its sign indicates the direction. |

| | | | | |
|-------------------|-----------|-------------|-------------|---|
| Speed | | $[LT^{-1}]$ | $m\ s^{-1}$ | |
| (a) Average | | | | $= \frac{\text{Path length}}{\text{Time interval}}$ |
| (b) Instantaneous | | | | $= \frac{dx}{dt}$ |
| Acceleration | | $[LT^{-2}]$ | $m\ s^{-2}$ | |
| (a) Average | \bar{a} | | | $= \frac{\Delta v}{\Delta t}$ |
| (b) Instantaneous | a | | | $= \lim_{\Delta t \rightarrow 0} \frac{\Delta v}{\Delta t} = \frac{dv}{dt}$ |
| | | | | In one dimension, its sign indicates the direction. |

POINTS TO PONDER

1. The origin and the positive direction of an axis are a matter of choice. You should first specify this choice before you assign signs to quantities like displacement, velocity and acceleration.
2. If a particle is speeding up, acceleration is in the direction of velocity; if its speed is decreasing, acceleration is in the direction opposite to that of the velocity. This statement is independent of the choice of the origin and the axis.
3. The sign of acceleration does not tell us whether the particle's speed is increasing or decreasing. The sign of acceleration (as mentioned in point 3) depends on the choice of the positive direction of the axis. For example, if the vertically upward direction is chosen to be the positive direction of the axis, the acceleration due to gravity is negative. If a particle is falling under gravity, this acceleration, though negative, results in increase in speed. For a particle thrown upward, the same negative acceleration (of gravity) results in decrease in speed.
4. The zero velocity of a particle at any instant does not necessarily imply zero acceleration at that instant. A particle may be momentarily at rest and yet have non-zero acceleration. For example, a particle thrown up has zero velocity at its uppermost point but the acceleration at that instant continues to be the acceleration due to gravity.
5. In the kinematic equations of motion [Eq. (2.9)], the various quantities are algebraic, i.e. they may be positive or negative. The equations are applicable in all situations (for one dimensional motion with constant acceleration) provided the values of different quantities are substituted in the equations with proper signs.
6. The definitions of instantaneous velocity and acceleration (Eqs. (2.1) and (2.3)) are exact and are always correct while the kinematic equations (Eq. (2.9)) are true only for motion in which the magnitude and the direction of acceleration are constant during the course of motion.

EXERCISES

- 2.1** In which of the following examples of motion, can the body be considered approximately a point object:
- a railway carriage moving without jerks between two stations.
 - a monkey sitting on top of a man cycling smoothly on a circular track.
 - a spinning cricket ball that turns sharply on hitting the ground.
 - a tumbling beaker that has slipped off the edge of a table.
- 2.2** The position-time ($x-t$) graphs for two children A and B returning from their school O to their homes P and Q respectively are shown in Fig. 2.9. Choose the correct entries in the brackets below ;
- (A/B) lives closer to the school than (B/A)
 - (A/B) starts from the school earlier than (B/A)
 - (A/B) walks faster than (B/A)
 - A and B reach home at the (same/different) time
 - (A/B) overtakes (B/A) on the road (once/twice).

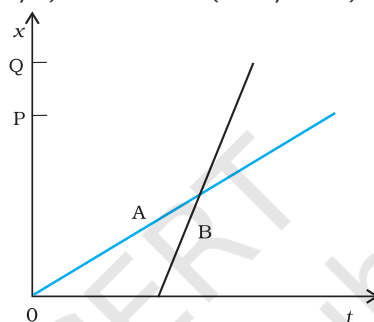

Fig. 2.9

- 2.3** A woman starts from her home at 9.00 am, walks with a speed of 5 km h^{-1} on a straight road up to her office 2.5 km away, stays at the office up to 5.00 pm, and returns home by an auto with a speed of 25 km h^{-1} . Choose suitable scales and plot the $x-t$ graph of her motion.
- 2.4** A drunkard walking in a narrow lane takes 5 steps forward and 3 steps backward, followed again by 5 steps forward and 3 steps backward, and so on. Each step is 1 m long and requires 1 s. Plot the $x-t$ graph of his motion. Determine graphically and otherwise how long the drunkard takes to fall in a pit 13 m away from the start.
- 2.5** A car moving along a straight highway with speed of 126 km h^{-1} is brought to a stop within a distance of 200 m. What is the retardation of the car (assumed uniform), and how long does it take for the car to stop ?
- 2.6** A player throws a ball upwards with an initial speed of 29.4 m s^{-1} .
- What is the direction of acceleration during the upward motion of the ball ?
 - What are the velocity and acceleration of the ball at the highest point of its motion ?
 - Choose the $x = 0 \text{ m}$ and $t = 0 \text{ s}$ to be the location and time of the ball at its highest point, vertically downward direction to be the positive direction of x -axis, and give the signs of position, velocity and acceleration of the ball during its upward, and downward motion.
 - To what height does the ball rise and after how long does the ball return to the player's hands ? (Take $g = 9.8 \text{ m s}^{-2}$ and neglect air resistance).
- 2.7** Read each statement below carefully and state with reasons and examples, if it is true or false ;
- A particle in one-dimensional motion
- with zero speed at an instant may have non-zero acceleration at that instant
 - with zero speed may have non-zero velocity,
 - with constant speed must have zero acceleration,
 - with positive value of acceleration *must* be speeding up.

2.8 A ball is dropped from a height of 90 m on a floor. At each collision with the floor, the ball loses one tenth of its speed. Plot the speed-time graph of its motion between $t = 0$ to 12 s.

2.9 Explain clearly, with examples, the distinction between :

- (a) magnitude of displacement (sometimes called distance) over an interval of time, and the total length of path covered by a particle over the same interval;
 (b) magnitude of average velocity over an interval of time, and the average speed over the same interval. [Average speed of a particle over an interval of time is defined as the total path length divided by the time interval]. Show in both (a) and (b) that the second quantity is either greater than or equal to the first. When is the equality sign true ? [For simplicity, consider one-dimensional motion only].

2.10 A man walks on a straight road from his home to a market 2.5 km away with a speed of 5 km h^{-1} . Finding the market closed, he instantly turns and walks back home with a speed of 7.5 km h^{-1} . What is the

- (a) magnitude of average velocity, and
 (b) average speed of the man over the interval of time (i) 0 to 30 min, (ii) 0 to 50 min, (iii) 0 to 40 min ?
 [Note: You will appreciate from this exercise why it is better to define average speed as total path length divided by time, and not as magnitude of average velocity. You would not like to tell the tired man on his return home that his average speed was zero !]

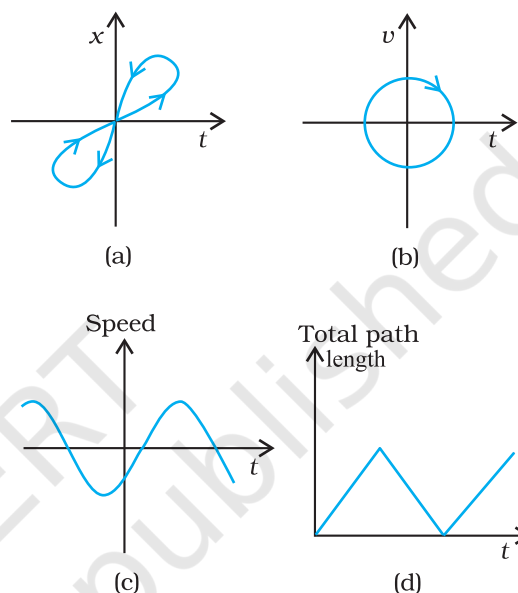

Fig. 2.10

2.11 In Exercises 2.9 and 2.10, we have carefully distinguished between *average speed* and magnitude of *average velocity*. No such distinction is necessary when we consider instantaneous speed and magnitude of velocity. The instantaneous speed is always equal to the magnitude of instantaneous velocity. Why?

2.12 Look at the graphs (a) to (d) (Fig. 2.10) carefully and state, with reasons, which of these *cannot* possibly represent one-dimensional motion of a particle.

2.13 Figure 2.11 shows the x - t plot of one-dimensional motion of a particle. Is it correct to say from the graph that the particle moves in a straight line for $t < 0$ and on a parabolic path for $t > 0$? If not, suggest a suitable physical context for this graph.

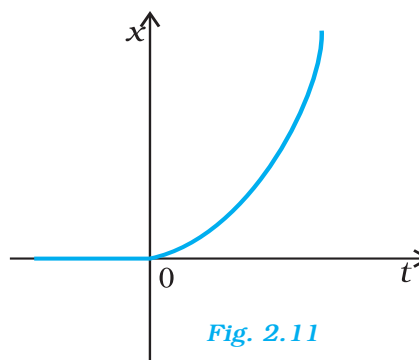

Fig. 2.11

2.14 A police van moving on a highway with a speed of 30 km h^{-1} fires a bullet at a thief's car speeding away in the same direction with a speed of 192 km h^{-1} . If the muzzle speed of the bullet is 150 m s^{-1} , with what speed does the bullet hit the thief's car? (Note: Obtain that speed which is relevant for damaging the thief's car).

2.15 Suggest a suitable physical situation for each of the following graphs (Fig 2.12):

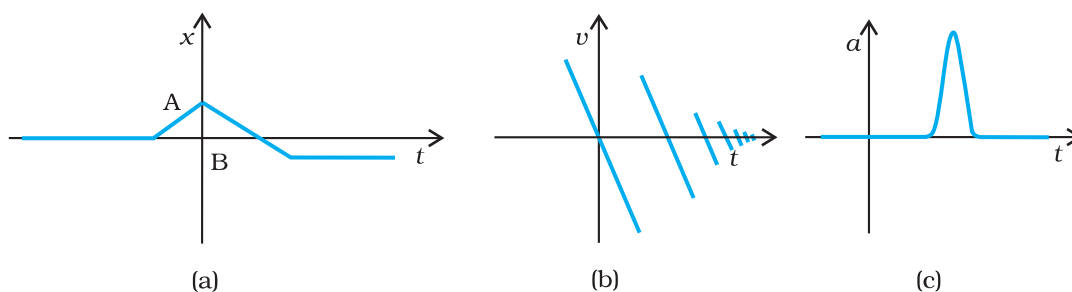

Fig. 2.12

2.16 Figure 2.13 gives the $x-t$ plot of a particle executing one-dimensional simple harmonic motion. (You will learn about this motion in more detail in Chapter 13). Give the signs of position, velocity and acceleration variables of the particle at $t = 0.3$ s, 1.2 s, -1.2 s.

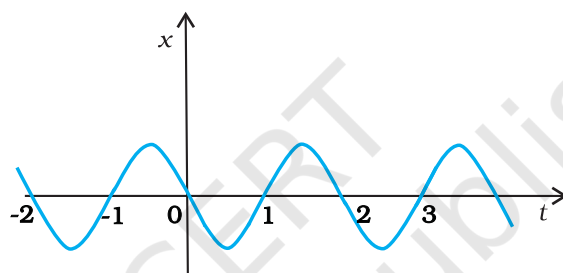

Fig. 2.13

2.17 Figure 2.14 gives the $x-t$ plot of a particle in one-dimensional motion. Three different equal intervals of time are shown. In which interval is the average speed greatest, and in which is it the least? Give the sign of average velocity for each interval.

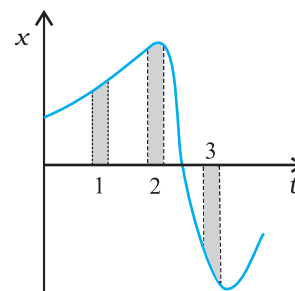

Fig. 2.14

2.18 Figure 2.15 gives a speed-time graph of a particle in motion along a constant direction. Three equal intervals of time are shown. In which interval is the average acceleration greatest in magnitude? In which interval is the average speed greatest? Choosing the positive direction as the constant direction of motion, give the signs of v and a in the three intervals. What are the accelerations at the points A, B, C and D?

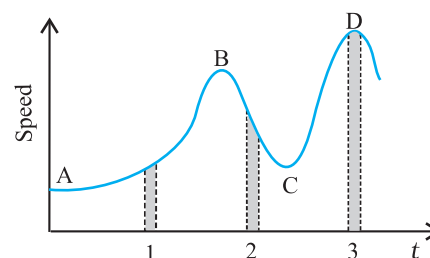

Fig. 2.15



MOTION IN A PLANE

- 3.1 Introduction
- 3.2 Scalars and vectors
- 3.3 Multiplication of vectors by real numbers
- 3.4 Addition and subtraction of vectors — graphical method
- 3.5 Resolution of vectors
- 3.6 Vector addition — analytical method
- 3.7 Motion in a plane
- 3.8 Motion in a plane with constant acceleration
- 3.9 Projectile motion
- 3.10 Uniform circular motion

Summary
Points to ponder
Exercises

3.1 INTRODUCTION

In the last chapter we developed the concepts of position, displacement, velocity and acceleration that are needed to describe the motion of an object along a straight line. We found that the directional aspect of these quantities can be taken care of by + and – signs, as in one dimension only two directions are possible. But in order to describe motion of an object in two dimensions (a plane) or three dimensions (space), we need to use vectors to describe the above-mentioned physical quantities. Therefore, it is first necessary to learn the language of vectors. What is a vector? How to add, subtract and multiply vectors? What is the result of multiplying a vector by a real number? We shall learn this to enable us to use vectors for defining velocity and acceleration in a plane. We then discuss motion of an object in a plane. As a simple case of motion in a plane, we shall discuss motion with constant acceleration and treat in detail the projectile motion. Circular motion is a familiar class of motion that has a special significance in daily-life situations. We shall discuss uniform circular motion in some detail.

The equations developed in this chapter for motion in a plane can be easily extended to the case of three dimensions.

3.2 SCALARS AND VECTORS

In physics, we can classify quantities as scalars or vectors. Basically, the difference is that a **direction** is associated with a vector but not with a scalar. A scalar quantity is a quantity with magnitude only. It is specified completely by a single number, along with the proper unit. Examples are : the distance between two points, mass of an object, the temperature of a body and the time at which a certain event happened. The rules for combining scalars are the rules of ordinary algebra. Scalars can be added, subtracted, multiplied and divided

just as the ordinary numbers*. For example, if the length and breadth of a rectangle are 1.0 m and 0.5 m respectively, then its perimeter is the sum of the lengths of the four sides, $1.0\text{ m} + 0.5\text{ m} + 1.0\text{ m} + 0.5\text{ m} = 3.0\text{ m}$. The length of each side is a scalar and the perimeter is also a scalar. Take another example: the maximum and minimum temperatures on a particular day are 35.6 C and 24.2 C respectively. Then, the difference between the two temperatures is 11.4 C. Similarly, if a uniform solid cube of aluminium of side 10 cm has a mass of 2.7 kg, then its volume is 10^{-3} m^3 (a scalar) and its density is $2.7 \times 10^3\text{ kg m}^{-3}$ (a scalar).

A **vector** quantity is a quantity that has both a magnitude and a direction and obeys the **triangle law of addition** or equivalently the **parallelogram law of addition**. So, a vector is specified by giving its magnitude by a number and its direction. Some physical quantities that are represented by vectors are displacement, velocity, acceleration and force.

To represent a vector, we use a bold face type in this book. Thus, a velocity vector can be represented by a symbol \mathbf{v} . Since bold face is difficult to produce, when written by hand, a vector is often represented by an arrow placed over a letter, say \vec{v} . Thus, both \mathbf{v} and \vec{v} represent the velocity vector. The magnitude of a vector is often called its absolute value, indicated by $|\mathbf{v}| = v$. Thus, a vector is represented by a bold face, e.g. by \mathbf{A} , \mathbf{a} , \mathbf{p} , \mathbf{q} , \mathbf{r} , ... \mathbf{x} , \mathbf{y} , with respective magnitudes denoted by light face A , a , p , q , r , ... x , y .

3.2.1 Position and Displacement Vectors

To describe the position of an object moving in a plane, we need to choose a convenient point, say O as origin. Let P and P' be the positions of the object at time t and t' , respectively [Fig. 3.1(a)]. We join O and P by a straight line. Then, \mathbf{OP} is the position vector of the object at time t . An arrow is marked at the head of this line. It is represented by a symbol \mathbf{r} , i.e. $\mathbf{OP} = \mathbf{r}$. Point P' is

represented by another position vector, \mathbf{OP}' denoted by \mathbf{r}' . The length of the vector \mathbf{r} represents the magnitude of the vector and its direction is the direction in which P lies as seen from O. If the object moves from P to P', the vector \mathbf{PP}' (with tail at P and tip at P') is called the **displacement vector** corresponding to motion from point P (at time t) to point P' (at time t').

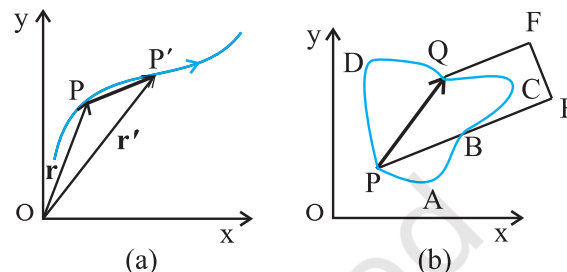

Fig. 3.1 (a) Position and displacement vectors. (b) Displacement vector \mathbf{PQ} and different courses of motion.

It is important to note that displacement vector is the straight line joining the initial and final positions and does not depend on the actual path undertaken by the object between the two positions. For example, in Fig. 3.1(b), given the initial and final positions as P and Q, the displacement vector is the same \mathbf{PQ} for different paths of journey, say PABCPQ, PDQ, and PBEFQ. Therefore, the **magnitude of displacement is either less or equal to the path length of an object between two points**. This fact was emphasised in the previous chapter also while discussing motion along a straight line.

3.2.2 Equality of Vectors

Two vectors \mathbf{A} and \mathbf{B} are said to be equal if, and only if, they have the same magnitude and the same direction.**

Figure 3.2(a) shows two equal vectors \mathbf{A} and \mathbf{B} . We can easily check their equality. Shift \mathbf{B} parallel to itself until its tail Q coincides with that of \mathbf{A} , i.e. Q coincides with O. Then, since their tips S and P also coincide, the two vectors are said to be equal. In general, equality is indicated

* Addition and subtraction of scalars make sense only for quantities with same units. However, you can multiply and divide scalars of different units.

** In our study, vectors do not have fixed locations. So displacing a vector parallel to itself leaves the vector unchanged. Such vectors are called free vectors. However, in some physical applications, location or line of application of a vector is important. Such vectors are called localised vectors.

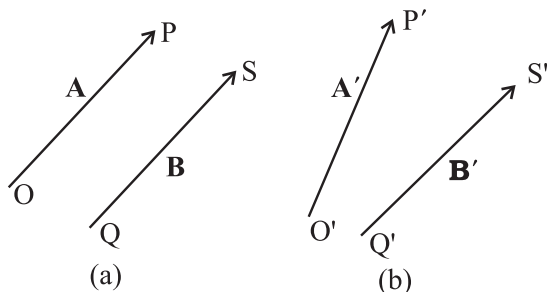

Fig. 3.2 (a) Two equal vectors \mathbf{A} and \mathbf{B} . (b) Two vectors \mathbf{A}' and \mathbf{B}' are unequal though they are of the same length.

as $\mathbf{A} = \mathbf{B}$. Note that in Fig. 3.2(b), vectors \mathbf{A}' and \mathbf{B}' have the same magnitude but they are not equal because they have different directions. Even if we shift \mathbf{B}' parallel to itself so that its tail Q' coincides with the tail O' of \mathbf{A}' , the tip S' of \mathbf{B}' does not coincide with the tip P' of \mathbf{A}' .

3.3 MULTIPLICATION OF VECTORS BY REAL NUMBERS

Multiplying a vector \mathbf{A} with a positive number λ gives a vector whose magnitude is changed by the factor λ but the direction is the same as that of \mathbf{A} :

$$|\lambda \mathbf{A}| = \lambda |\mathbf{A}| \text{ if } \lambda > 0.$$

For example, if \mathbf{A} is multiplied by 2, the resultant vector $2\mathbf{A}$ is in the same direction as \mathbf{A} and has a magnitude twice of $|\mathbf{A}|$ as shown in Fig. 3.3(a).

Multiplying a vector \mathbf{A} by a negative number $-\lambda$ gives another vector whose direction is opposite to the direction of \mathbf{A} and whose magnitude is λ times $|\mathbf{A}|$.

Multiplying a given vector \mathbf{A} by negative numbers, say -1 and -1.5 , gives vectors as shown in Fig 3.3(b).

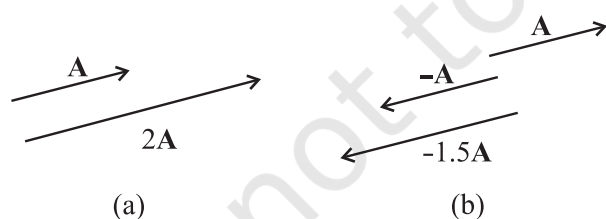

Fig. 3.3 (a) Vector \mathbf{A} and the resultant vector after multiplying \mathbf{A} by a positive number 2. (b) Vector \mathbf{A} and resultant vectors after multiplying it by a negative number -1 and -1.5 .

The factor λ by which a vector \mathbf{A} is multiplied could be a scalar having its own physical dimension. Then, the dimension of $\lambda \mathbf{A}$ is the product of the dimensions of λ and \mathbf{A} . For example, if we multiply a constant velocity vector by duration (of time), we get a displacement vector.

3.4 ADDITION AND SUBTRACTION OF VECTORS — GRAPHICAL METHOD

As mentioned in section 4.2, vectors, by definition, obey the triangle law or equivalently, the parallelogram law of addition. We shall now describe this law of addition using the graphical method. Let us consider two vectors \mathbf{A} and \mathbf{B} that lie in a plane as shown in Fig. 3.4(a). The lengths of the line segments representing these vectors are proportional to the magnitude of the vectors. To find the sum $\mathbf{A} + \mathbf{B}$, we place vector \mathbf{B} so that its tail is at the head of the vector \mathbf{A} , as in Fig. 3.4(b). Then, we join the tail of \mathbf{A} to the head of \mathbf{B} . This line OQ represents a vector \mathbf{R} , that is, the sum of the vectors \mathbf{A} and \mathbf{B} . Since, in this procedure of vector addition, vectors are

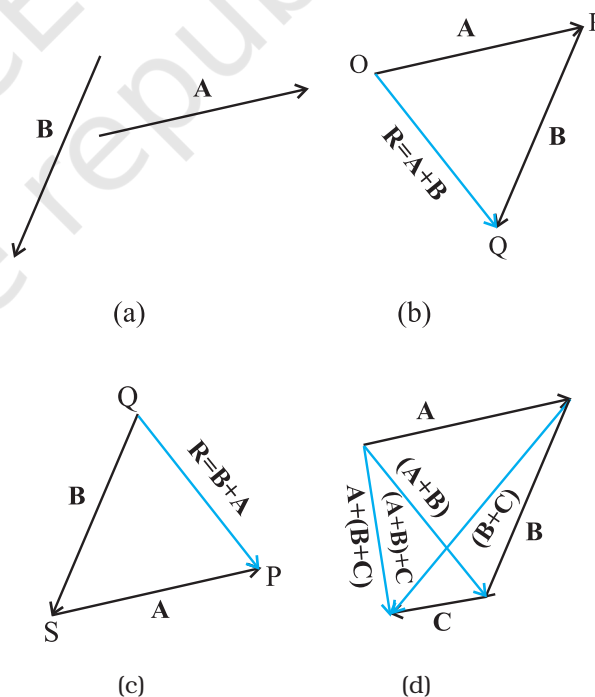

Fig. 3.4 (a) Vectors \mathbf{A} and \mathbf{B} . (b) Vectors \mathbf{A} and \mathbf{B} added graphically. (c) Vectors \mathbf{B} and \mathbf{A} added graphically. (d) Illustrating the associative law of vector addition.

arranged head to tail, this graphical method is called the **head-to-tail method**. The two vectors and their resultant form three sides of a triangle, so this method is also known as **triangle method of vector addition**. If we find the resultant of $\mathbf{B} + \mathbf{A}$ as in Fig. 3.4(c), the same vector \mathbf{R} is obtained. Thus, vector addition is **commutative**:

$$\mathbf{A} + \mathbf{B} = \mathbf{B} + \mathbf{A} \quad (3.1)$$

The addition of vectors also obeys the associative law as illustrated in Fig. 3.4(d). The result of adding vectors \mathbf{A} and \mathbf{B} first and then adding vector \mathbf{C} is the same as the result of adding vector \mathbf{B} and \mathbf{C} first and then adding vector \mathbf{A} :

$$(\mathbf{A} + \mathbf{B}) + \mathbf{C} = \mathbf{A} + (\mathbf{B} + \mathbf{C}) \quad (3.2)$$

What is the result of adding two equal and opposite vectors? Consider two vectors \mathbf{A} and $-\mathbf{A}$ shown in Fig. 3.3(b). Their sum is $\mathbf{A} + (-\mathbf{A})$. Since the magnitudes of the two vectors are the same, but the directions are opposite, the resultant vector has zero magnitude and is represented by $\mathbf{0}$ called a **null vector** or a **zero vector**:

$$\mathbf{A} - \mathbf{A} = \mathbf{0} \quad |\mathbf{0}| = 0 \quad (3.3)$$

Since the magnitude of a null vector is zero, its direction cannot be specified.

The null vector also results when we multiply a vector \mathbf{A} by the number zero. The main properties of $\mathbf{0}$ are:

$$\begin{aligned} \mathbf{A} + \mathbf{0} &= \mathbf{A} \\ \lambda \mathbf{0} &= \mathbf{0} \\ 0 \mathbf{A} &= \mathbf{0} \end{aligned} \quad (3.4)$$

What is the physical meaning of a zero vector? Consider the position and displacement vectors in a plane as shown in Fig. 3.1(a). Now suppose that an object which is at P at time t , moves to P' and then comes back to P. Then, what is its displacement? Since the initial and final positions coincide, the displacement is a “null vector”.

Subtraction of vectors can be defined in terms of addition of vectors. We define the difference of two vectors \mathbf{A} and \mathbf{B} as the sum of two vectors \mathbf{A} and $-\mathbf{B}$:

$$\mathbf{A} - \mathbf{B} = \mathbf{A} + (-\mathbf{B}) \quad (3.5)$$

It is shown in Fig 3.5. The vector $-\mathbf{B}$ is added to vector \mathbf{A} to get $\mathbf{R}_2 = (\mathbf{A} - \mathbf{B})$. The vector $\mathbf{R}_1 = \mathbf{A} + \mathbf{B}$ is also shown in the same figure for comparison. We can also use the **parallelogram method** to find the sum of two vectors. Suppose we have two vectors \mathbf{A} and \mathbf{B} . To add these vectors, we bring their tails to a common origin O as shown in Fig. 3.6(a). Then we draw a line from the head of \mathbf{A} parallel to \mathbf{B} and another line from the head of \mathbf{B} parallel to \mathbf{A} to complete a parallelogram OQSP. Now we join the point of the intersection of these two lines to the origin O. The resultant vector \mathbf{R} is directed from the common origin O along the diagonal (OS) of the parallelogram [Fig. 3.6(b)]. In Fig.3.6(c), the triangle law is used to obtain the resultant of \mathbf{A} and \mathbf{B} and we see that the two methods yield the same result. Thus, the two methods are equivalent.

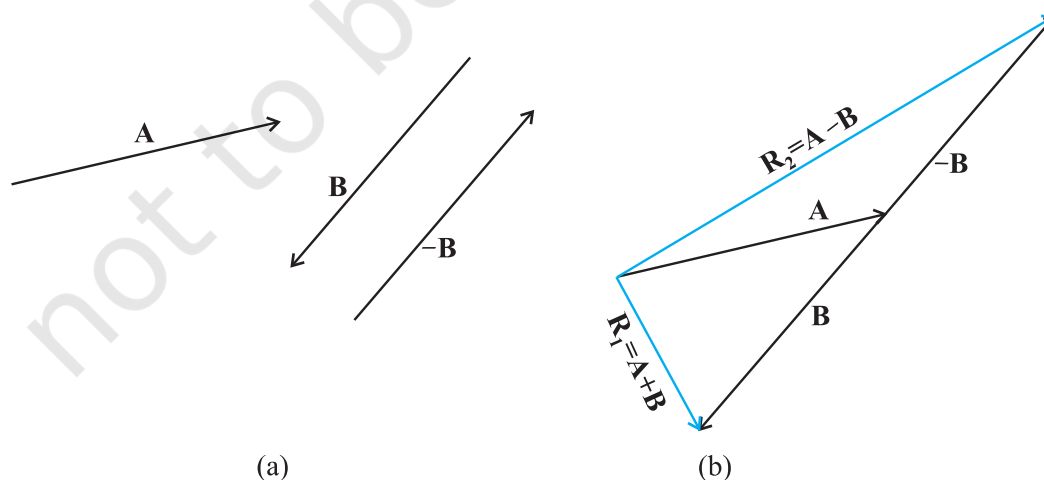

Fig. 3.5 (a) Two vectors \mathbf{A} and \mathbf{B} , $-\mathbf{B}$ is also shown. (b) Subtracting vector \mathbf{B} from vector \mathbf{A} – the result is \mathbf{R}_2 . For comparison, addition of vectors \mathbf{A} and \mathbf{B} , i.e. \mathbf{R}_1 is also shown.

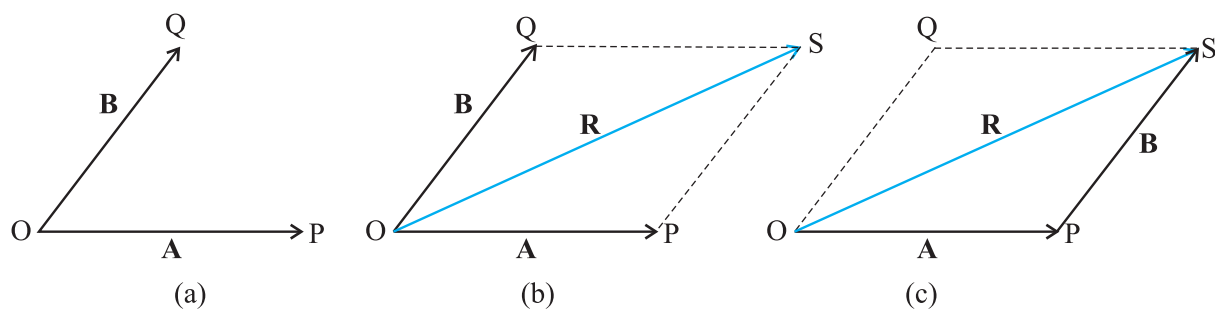

Fig. 3.6 (a) Two vectors **A** and **B** with their tails brought to a common origin. (b) The sum $\mathbf{A} + \mathbf{B}$ obtained using the parallelogram method. (c) The parallelogram method of vector addition is equivalent to the triangle method.

► **Example 3.1** Rain is falling vertically with a speed of 35 m s^{-1} . Winds starts blowing after sometime with a speed of 12 m s^{-1} in east to west direction. In which direction should a boy waiting at a bus stop hold his umbrella ?

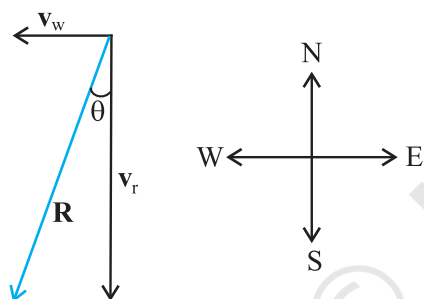

Fig. 3.7

Answer The velocity of the rain and the wind are represented by the vectors \mathbf{v}_r and \mathbf{v}_w in Fig. 3.7 and are in the direction specified by the problem. Using the rule of vector addition, we see that the resultant of \mathbf{v}_r and \mathbf{v}_w is **R** as shown in the figure. The magnitude of **R** is

$$R = \sqrt{v_r^2 + v_w^2} = \sqrt{35^2 + 12^2} \text{ m s}^{-1} = 37 \text{ m s}^{-1}$$

The direction θ that **R** makes with the vertical is given by

$$\tan \theta = \frac{v_w}{v_r} = \frac{12}{35} = 0.343$$

Or, $\theta = \tan^{-1}(0.343) = 19^\circ$

Therefore, the boy should hold his umbrella in the vertical plane at an angle of about 19° with the vertical towards the east. ◀

3.5 RESOLUTION OF VECTORS

Let **a** and **b** be any two non-zero vectors in a plane with different directions and let **A** be another vector in the same plane (Fig. 3.8). **A** can be expressed as a sum of two vectors — one obtained by multiplying **a** by a real number and the other obtained by multiplying **b** by another real number. To see this, let **O** and **P** be the tail and head of the vector **A**. Then, through **O**, draw a straight line parallel to **a**, and through **P**, draw a straight line parallel to **b**. Let them intersect at **Q**. Then, we have

$$\mathbf{A} = \mathbf{OP} = \mathbf{OQ} + \mathbf{QP} \quad (3.6)$$

But since **OQ** is parallel to **a**, and **QP** is parallel to **b**, we can write :

$$\mathbf{OQ} = \lambda \mathbf{a}, \text{ and } \mathbf{QP} = \mu \mathbf{b} \quad (3.7)$$

where λ and μ are real numbers.

Therefore, $\mathbf{A} = \lambda \mathbf{a} + \mu \mathbf{b}$ (3.8)

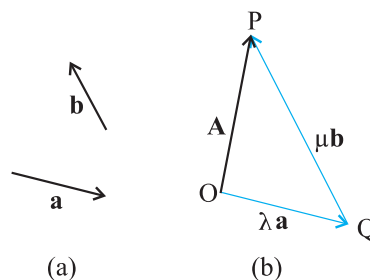

Fig. 3.8 (a) Two non-collinear vectors **a** and **b**. (b) Resolving a vector **A** in terms of vectors **a** and **b**.

We say that **A** has been resolved into two component vectors $\lambda \mathbf{a}$ and $\mu \mathbf{b}$ along **a** and **b**

respectively. Using this method one can resolve a given vector into two component vectors along a set of two vectors – all the three lie in the same plane. It is convenient to resolve a general vector along the axes of a rectangular coordinate system using vectors of unit magnitude. These are called unit vectors that we discuss now. A unit vector is a vector of unit magnitude and points in a particular direction. It has no dimension and unit. It is used to specify a direction only. Unit vectors along the x -, y - and z -axes of a rectangular coordinate system are denoted by $\hat{\mathbf{i}}$, $\hat{\mathbf{j}}$ and $\hat{\mathbf{k}}$, respectively, as shown in Fig. 3.9(a).

Since these are unit vectors, we have

$$|\hat{\mathbf{i}}| = |\hat{\mathbf{j}}| = |\hat{\mathbf{k}}| = 1 \quad (3.9)$$

These unit vectors are perpendicular to each other. In this text, they are printed in bold face with a cap (^) to distinguish them from other vectors. Since we are dealing with motion in two dimensions in this chapter, we require use of only two unit vectors. If we multiply a unit vector, say $\hat{\mathbf{n}}$ by a scalar, the result is a vector

$\lambda = \lambda \hat{\mathbf{n}}$. In general, a vector \mathbf{A} can be written as

$$\mathbf{A} = |\mathbf{A}| \hat{\mathbf{n}} \quad (3.10)$$

where $\hat{\mathbf{n}}$ is a unit vector along \mathbf{A} .

We can now resolve a vector \mathbf{A} in terms of component vectors that lie along unit vectors $\hat{\mathbf{i}}$ and $\hat{\mathbf{j}}$. Consider a vector \mathbf{A} that lies in x - y plane as shown in Fig. 3.9(b). We draw lines from the head of \mathbf{A} perpendicular to the coordinate axes as in Fig. 3.9(b), and get vectors \mathbf{A}_1 and \mathbf{A}_2 such that $\mathbf{A}_1 + \mathbf{A}_2 = \mathbf{A}$. Since \mathbf{A}_1 is parallel to $\hat{\mathbf{i}}$

and \mathbf{A}_2 is parallel to $\hat{\mathbf{j}}$, we have :

$$\mathbf{A}_1 = A_x \hat{\mathbf{i}}, \quad \mathbf{A}_2 = A_y \hat{\mathbf{j}} \quad (3.11)$$

where A_x and A_y are real numbers.

$$\text{Thus, } \mathbf{A} = A_x \hat{\mathbf{i}} + A_y \hat{\mathbf{j}} \quad (3.12)$$

This is represented in Fig. 3.9(c). The quantities A_x and A_y are called x -, and y - components of the vector \mathbf{A} . Note that A_x is itself not a vector, but $A_x \hat{\mathbf{i}}$ is a vector, and so is $A_y \hat{\mathbf{j}}$. Using simple trigonometry, we can express A_x and A_y in terms of the magnitude of \mathbf{A} and the angle θ it makes with the x -axis :

$$\begin{aligned} A_x &= A \cos \theta \\ A_y &= A \sin \theta \end{aligned} \quad (3.13)$$

As is clear from Eq. (3.13), a component of a vector can be positive, negative or zero depending on the value of θ .

Now, we have two ways to specify a vector \mathbf{A} in a plane. It can be specified by :

- (i) its magnitude A and the direction θ it makes with the x -axis; or
- (ii) its components A_x and A_y

If A and θ are given, A_x and A_y can be obtained using Eq. (3.13). If A_x and A_y are given, A and θ can be obtained as follows :

$$\begin{aligned} A_x^2 + A_y^2 &= A^2 \cos^2 \theta + A^2 \sin^2 \theta \\ &= A^2 \end{aligned}$$

$$\text{Or, } A = \sqrt{A_x^2 + A_y^2} \quad (3.14)$$

$$\text{And } \tan \theta = \frac{A_y}{A_x}, \quad \theta = \tan^{-1} \frac{A_y}{A_x} \quad (3.15)$$

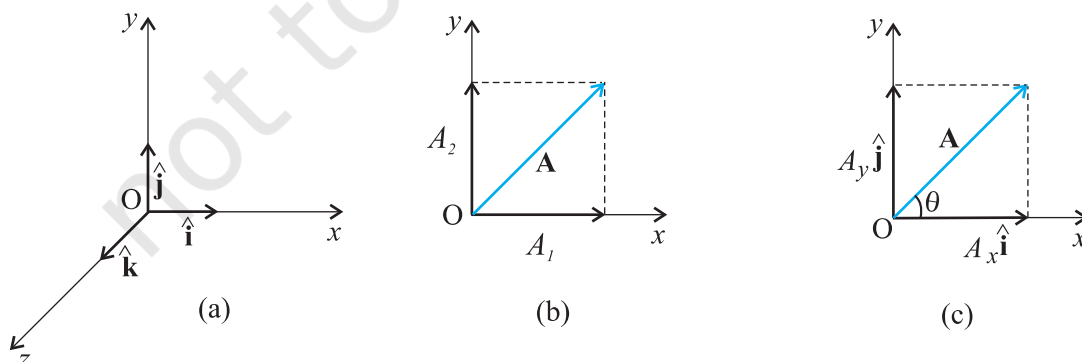

Fig. 3.9 (a) Unit vectors $\hat{\mathbf{i}}$, $\hat{\mathbf{j}}$ and $\hat{\mathbf{k}}$ lie along the x -, y -, and z -axes. (b) A vector \mathbf{A} is resolved into its components A_x and A_y along x -, and y - axes. (c) \mathbf{A}_1 and \mathbf{A}_2 expressed in terms of $\hat{\mathbf{i}}$ and $\hat{\mathbf{j}}$.

So far we have considered a vector lying in an x - y plane. The same procedure can be used to resolve a general vector \mathbf{A} into three components along x -, y -, and z -axes in three dimensions. If α , β , and γ are the angles* between \mathbf{A} and the x -, y -, and z -axes, respectively [Fig. 3.9(d)], we have

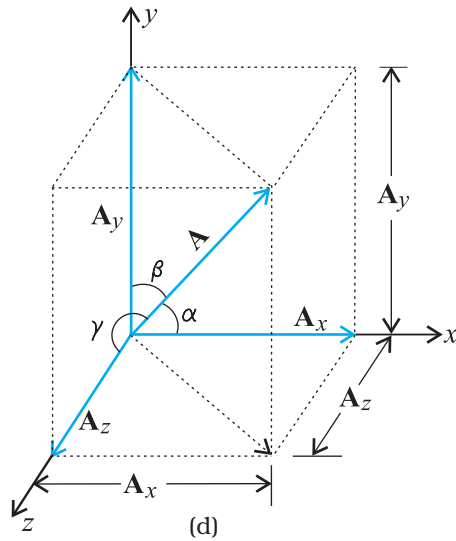

Fig. 3.9 (d) A vector \mathbf{A} resolved into components along x -, y -, and z -axes

$$A_x = A \cos \alpha, \quad A_y = A \cos \beta, \quad A_z = A \cos \gamma \quad (3.16a)$$

In general, we have

$$\mathbf{A} = A_x \hat{\mathbf{i}} + A_y \hat{\mathbf{j}} + A_z \hat{\mathbf{k}} \quad (3.16b)$$

The magnitude of vector \mathbf{A} is

$$A = \sqrt{A_x^2 + A_y^2 + A_z^2} \quad (3.16c)$$

A position vector \mathbf{r} can be expressed as

$$\mathbf{r} = x \hat{\mathbf{i}} + y \hat{\mathbf{j}} + z \hat{\mathbf{k}} \quad (3.17)$$

where x , y , and z are the components of \mathbf{r} along x -, y -, z -axes, respectively.

3.6 VECTOR ADDITION - ANALYTICAL METHOD

Although the graphical method of adding vectors helps us in visualising the vectors and the resultant vector, it is sometimes tedious and has limited accuracy. It is much easier to add vectors by combining their respective components. Consider two vectors \mathbf{A} and \mathbf{B} in x - y plane with components A_x , A_y and B_x , B_y :

$$\mathbf{A} = A_x \hat{\mathbf{i}} + A_y \hat{\mathbf{j}} \quad (3.18)$$

$$\mathbf{B} = B_x \hat{\mathbf{i}} + B_y \hat{\mathbf{j}}$$

Let \mathbf{R} be their sum. We have

$$\begin{aligned} \mathbf{R} &= \mathbf{A} + \mathbf{B} \\ &= (A_x \hat{\mathbf{i}} + A_y \hat{\mathbf{j}}) + (B_x \hat{\mathbf{i}} + B_y \hat{\mathbf{j}}) \end{aligned} \quad (3.19a)$$

Since vectors obey the commutative and associative laws, we can arrange and regroup the vectors in Eq. (3.19a) as convenient to us :

$$\mathbf{R} = (A_x + B_x) \hat{\mathbf{i}} + (A_y + B_y) \hat{\mathbf{j}} \quad (3.19b)$$

$$\text{Since } \mathbf{R} = R_x \hat{\mathbf{i}} + R_y \hat{\mathbf{j}} \quad (3.20)$$

$$\text{we have, } R_x = A_x + B_x, \quad R_y = A_y + B_y \quad (3.21)$$

Thus, each component of the resultant vector \mathbf{R} is the sum of the corresponding components of \mathbf{A} and \mathbf{B} .

In three dimensions, we have

$$\mathbf{A} = A_x \hat{\mathbf{i}} + A_y \hat{\mathbf{j}} + A_z \hat{\mathbf{k}}$$

$$\mathbf{B} = B_x \hat{\mathbf{i}} + B_y \hat{\mathbf{j}} + B_z \hat{\mathbf{k}}$$

$$\mathbf{R} = \mathbf{A} + \mathbf{B} = R_x \hat{\mathbf{i}} + R_y \hat{\mathbf{j}} + R_z \hat{\mathbf{k}}$$

$$\text{with } R_x = A_x + B_x$$

$$R_y = A_y + B_y$$

$$R_z = A_z + B_z \quad (3.22)$$

This method can be extended to addition and subtraction of any number of vectors. For example, if vectors \mathbf{a} , \mathbf{b} and \mathbf{c} are given as

$$\mathbf{a} = a_x \hat{\mathbf{i}} + a_y \hat{\mathbf{j}} + a_z \hat{\mathbf{k}}$$

$$\mathbf{b} = b_x \hat{\mathbf{i}} + b_y \hat{\mathbf{j}} + b_z \hat{\mathbf{k}}$$

$$\mathbf{c} = c_x \hat{\mathbf{i}} + c_y \hat{\mathbf{j}} + c_z \hat{\mathbf{k}} \quad (3.23a)$$

then, a vector $\mathbf{T} = \mathbf{a} + \mathbf{b} - \mathbf{c}$ has components :

$$T_x = a_x + b_x - c_x$$

$$T_y = a_y + b_y - c_y \quad (3.23b)$$

$$T_z = a_z + b_z - c_z.$$

► **Example 3.2** Find the magnitude and direction of the resultant of two vectors \mathbf{A} and \mathbf{B} in terms of their magnitudes and angle θ between them.

* Note that angles α , β , and γ are angles in space. They are between pairs of lines, which are not coplanar.

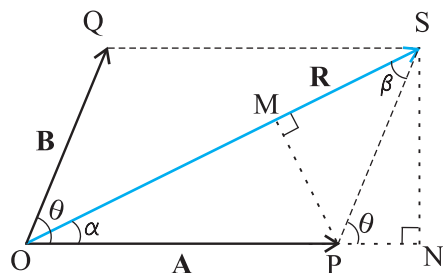

Fig. 3.10

Answer Let \mathbf{OP} and \mathbf{OQ} represent the two vectors \mathbf{A} and \mathbf{B} making an angle θ (Fig. 3.10). Then, using the parallelogram method of vector addition, \mathbf{OS} represents the resultant vector \mathbf{R} :

$$\mathbf{R} = \mathbf{A} + \mathbf{B}$$

SN is normal to OP and PM is normal to OS .

From the geometry of the figure,

$$OS^2 = ON^2 + SN^2$$

but $ON = OP + PN = A + B \cos \theta$

$$SN = B \sin \theta$$

$$OS^2 = (A + B \cos \theta)^2 + (B \sin \theta)^2$$

or, $R^2 = A^2 + B^2 + 2AB \cos \theta$

$$R = \sqrt{A^2 + B^2 + 2AB \cos \theta} \quad (3.24a)$$

In $\triangle OSN$, $SN = OS \sin \alpha = R \sin \alpha$, and

in $\triangle PSN$, $SN = PS \sin \theta = B \sin \theta$

Therefore, $R \sin \alpha = B \sin \theta$

$$\text{or, } \frac{R}{\sin \theta} = \frac{B}{\sin \alpha} \quad (3.24b)$$

Similarly,

$$PM = A \sin \alpha = B \sin \beta$$

$$\text{or, } \frac{A}{\sin \beta} = \frac{B}{\sin \alpha} \quad (3.24c)$$

Combining Eqs. (3.24b) and (3.24c), we get

$$\frac{R}{\sin \theta} = \frac{A}{\sin \beta} = \frac{B}{\sin \alpha} \quad (3.24d)$$

Using Eq. (3.24d), we get:

$$\sin \alpha = \frac{B}{R} \sin \theta \quad (3.24e)$$

where R is given by Eq. (3.24a).

$$\text{or, } \tan \alpha = \frac{SN}{OP + PN} = \frac{B \sin \theta}{A + B \cos \theta} \quad (3.24f)$$

Equation (3.24a) gives the magnitude of the resultant and Eqs. (3.24e) and (3.24f) its direction. Equation (3.24a) is known as the **Law of cosines** and Eq. (3.24d) as the **Law of sines**. ◀

▶ **Example 3.3** A motorboat is racing towards north at 25 km/h and the water current in that region is 10 km/h in the direction of 60° east of south. Find the resultant velocity of the boat.

Answer The vector \mathbf{v}_b representing the velocity of the motorboat and the vector \mathbf{v}_c representing the water current are shown in Fig. 3.11 in directions specified by the problem. Using the parallelogram method of addition, the resultant \mathbf{R} is obtained in the direction shown in the figure.

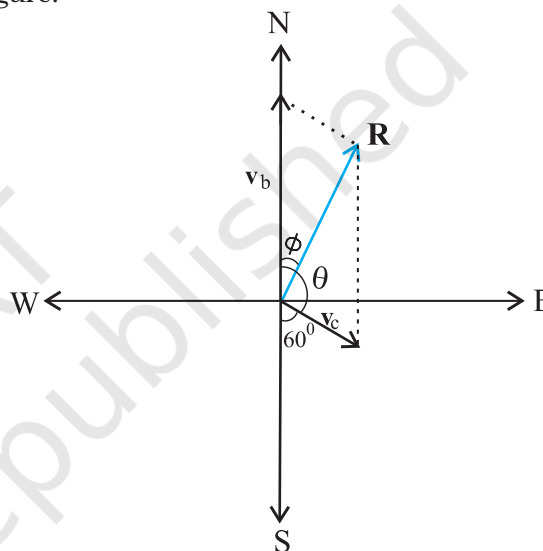

Fig. 3.11

We can obtain the magnitude of \mathbf{R} using the Law of cosine :

$$R = \sqrt{v_b^2 + v_c^2 + 2v_b v_c \cos 120^\circ}$$

$$= \sqrt{25^2 + 10^2 + 2 \times 25 \times 10 (-1/2)} \cong 22 \text{ km/h}$$

To obtain the direction, we apply the Law of sines

$$\frac{R}{\sin \theta} = \frac{v_c}{\sin \phi} \quad \text{or, } \sin \phi = \frac{v_c}{R} \sin \theta$$

$$= \frac{10 \times \sin 120^\circ}{21.8} = \frac{10\sqrt{3}}{2 \times 21.8} \cong 0.397$$

$$\phi \cong 23.4^\circ$$

3.7 MOTION IN A PLANE

In this section we shall see how to describe motion in two dimensions using vectors.

3.7.1 Position Vector and Displacement

The position vector \mathbf{r} of a particle P located in a plane with reference to the origin of an x - y reference frame (Fig. 3.12) is given by

$$\mathbf{r} = x\hat{\mathbf{i}} + y\hat{\mathbf{j}}$$

where x and y are components of \mathbf{r} along x -, and y - axes or simply they are the coordinates of the object.

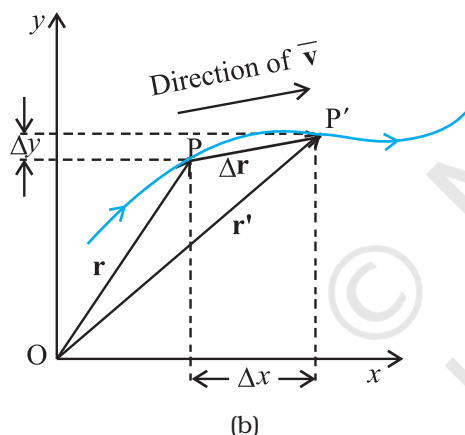
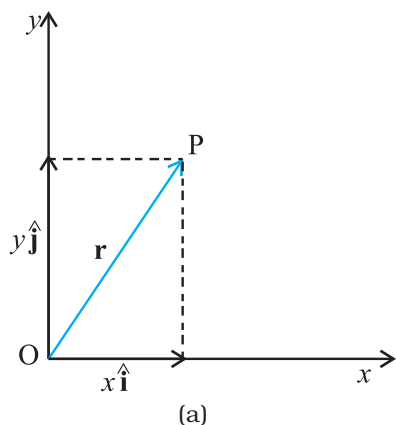

Fig. 3.12 (a) Position vector \mathbf{r} . (b) Displacement $\Delta\mathbf{r}$ and average velocity $\bar{\mathbf{v}}$ of a particle.

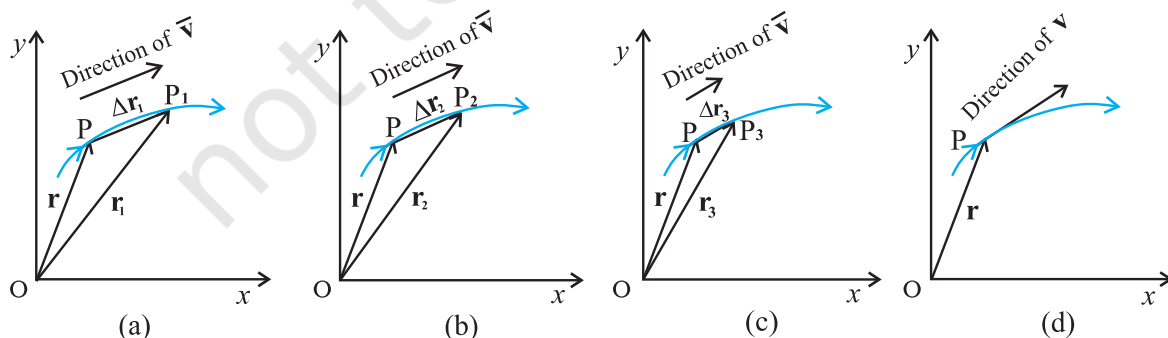

Fig. 3.13 As the time interval Δt approaches zero, the average velocity approaches the velocity \mathbf{v} . The direction of $\bar{\mathbf{v}}$ is parallel to the line tangent to the path.

Suppose a particle moves along the curve shown by the thick line and is at P at time t and P' at time t' [Fig. 3.12(b)]. Then, the displacement is :

$$\Delta\mathbf{r} = \mathbf{r}' - \mathbf{r} \quad (3.25)$$

and is directed from P to P' .

We can write Eq. (3.25) in a component form:

$$\begin{aligned} \Delta\mathbf{r} &= (x'\hat{\mathbf{i}} + y'\hat{\mathbf{j}}) - (x\hat{\mathbf{i}} + y\hat{\mathbf{j}}) \\ &= \hat{\mathbf{i}}\Delta x + \hat{\mathbf{j}}\Delta y \end{aligned} \quad (3.26)$$

where $\Delta x = x' - x$, $\Delta y = y' - y$

Velocity

The average velocity ($\bar{\mathbf{v}}$) of an object is the ratio of the displacement and the corresponding time interval :

$$\bar{\mathbf{v}} = \frac{\Delta\mathbf{r}}{\Delta t} = \frac{\Delta x\hat{\mathbf{i}} + \Delta y\hat{\mathbf{j}}}{\Delta t} = \hat{\mathbf{i}}\frac{\Delta x}{\Delta t} + \hat{\mathbf{j}}\frac{\Delta y}{\Delta t} \quad (3.27)$$

Or, $\bar{\mathbf{v}} = \bar{v}_x\hat{\mathbf{i}} + \bar{v}_y\hat{\mathbf{j}}$

Since $\bar{\mathbf{v}} = \frac{\Delta\mathbf{r}}{\Delta t}$, the direction of the average velocity

is the same as that of $\Delta\mathbf{r}$ (Fig. 3.12). The **velocity** (instantaneous velocity) is given by the limiting value of the average velocity as the time interval approaches zero :

$$\mathbf{v} = \lim_{\Delta t \rightarrow 0} \frac{\Delta\mathbf{r}}{\Delta t} = \frac{d\mathbf{r}}{dt} \quad (3.28)$$

The meaning of the limiting process can be easily understood with the help of Fig 3.13(a) to (d). In these figures, the thick line represents the path of an object, which is at P at time t . P_1 , P_2 and P_3 represent the positions of the object after times Δt_1 , Δt_2 , and Δt_3 . $\Delta\mathbf{r}_1$, $\Delta\mathbf{r}_2$, and $\Delta\mathbf{r}_3$ are the displacements of the object in times Δt_1 , Δt_2 , and

Δt_3 , respectively. The direction of the average velocity $\bar{\mathbf{v}}$ is shown in figures (a), (b) and (c) for three decreasing values of Δt , i.e. $\Delta t_1, \Delta t_2$, and Δt_3 , ($\Delta t_1 > \Delta t_2 > \Delta t_3$). As $\Delta t \rightarrow 0$, $\Delta \mathbf{r} \rightarrow 0$ and is along the tangent to the path [Fig. 3.13(d)]. Therefore, **the direction of velocity at any point on the path of an object is tangential to the path at that point and is in the direction of motion.**

We can express \mathbf{v} in a component form :

$$\begin{aligned} \mathbf{v} &= \frac{d\mathbf{r}}{dt} \\ &= \lim_{\Delta t \rightarrow 0} \left(\frac{\Delta x}{\Delta t} \hat{\mathbf{i}} + \frac{\Delta y}{\Delta t} \hat{\mathbf{j}} \right) \end{aligned} \quad (3.29)$$

$$= \hat{\mathbf{i}} \lim_{\Delta t \rightarrow 0} \frac{\Delta x}{\Delta t} + \hat{\mathbf{j}} \lim_{\Delta t \rightarrow 0} \frac{\Delta y}{\Delta t}$$

$$\text{Or, } \mathbf{v} = \hat{\mathbf{i}} \frac{dx}{dt} + \hat{\mathbf{j}} \frac{dy}{dt} = v_x \hat{\mathbf{i}} + v_y \hat{\mathbf{j}}.$$

$$\text{where } v_x = \frac{dx}{dt}, v_y = \frac{dy}{dt} \quad (3.30a)$$

So, if the expressions for the coordinates x and y are known as functions of time, we can use these equations to find v_x and v_y .

The magnitude of \mathbf{v} is then

$$v = \sqrt{v_x^2 + v_y^2} \quad (3.30b)$$

and the direction of \mathbf{v} is given by the angle θ :

$$\tan \theta = \frac{v_y}{v_x}, \quad \theta = \tan^{-1} \left(\frac{v_y}{v_x} \right) \quad (3.30c)$$

v_x , v_y and angle θ are shown in Fig. 3.14 for a velocity vector \mathbf{v} at point p .

Acceleration

The **average acceleration** $\bar{\mathbf{a}}$ of an object for a time interval Δt moving in x - y plane is the change in velocity divided by the time interval :

$$\bar{\mathbf{a}} = \frac{\Delta \mathbf{v}}{\Delta t} = \frac{\Delta(v_x \hat{\mathbf{i}} + v_y \hat{\mathbf{j}})}{\Delta t} = \frac{\Delta v_x}{\Delta t} \hat{\mathbf{i}} + \frac{\Delta v_y}{\Delta t} \hat{\mathbf{j}} \quad (3.31a)$$

$$\text{Or, } \bar{\mathbf{a}} = a_x \hat{\mathbf{i}} + a_y \hat{\mathbf{j}}. \quad (3.31b)$$

* In terms of x and y , a_x and a_y can be expressed as

$$a_x = \frac{d}{dt} \left(\frac{dx}{dt} \right) = \frac{d^2 x}{dt^2}, \quad a_y = \frac{d}{dt} \left(\frac{dy}{dt} \right) = \frac{d^2 y}{dt^2}$$

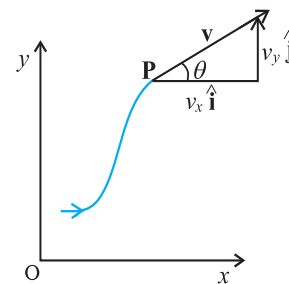

Fig. 3.14 The components v_x and v_y of velocity \mathbf{v} and the angle θ it makes with x -axis. Note that $v_x = v \cos \theta$, $v_y = v \sin \theta$.

The **acceleration** (instantaneous acceleration) is the limiting value of the average acceleration as the time interval approaches zero :

$$\mathbf{a} = \lim_{\Delta t \rightarrow 0} \frac{\Delta \mathbf{v}}{\Delta t} \quad (3.32a)$$

Since $\Delta \mathbf{v} = \Delta v_x \hat{\mathbf{i}} + \Delta v_y \hat{\mathbf{j}}$, we have

$$\mathbf{a} = \hat{\mathbf{i}} \lim_{\Delta t \rightarrow 0} \frac{\Delta v_x}{\Delta t} + \hat{\mathbf{j}} \lim_{\Delta t \rightarrow 0} \frac{\Delta v_y}{\Delta t}$$

$$\text{Or, } \mathbf{a} = a_x \hat{\mathbf{i}} + a_y \hat{\mathbf{j}} \quad (3.32b)$$

$$\text{where, } a_x = \frac{dv_x}{dt}, \quad a_y = \frac{dv_y}{dt} \quad (3.32c)^*$$

As in the case of velocity, we can understand graphically the limiting process used in defining acceleration on a graph showing the path of the object's motion. This is shown in Figs. 3.15(a) to (d). P represents the position of the object at time t and P_1, P_2, P_3 positions after time $\Delta t_1, \Delta t_2, \Delta t_3$, respectively ($\Delta t_1 > \Delta t_2 > \Delta t_3$). The velocity vectors at points P, P_1, P_2, P_3 are also shown in Figs. 3.15 (a), (b) and (c). In each case of Δt , $\Delta \mathbf{v}$ is obtained using the triangle law of vector addition. By definition, the direction of average acceleration is the same as that of $\Delta \mathbf{v}$. We see that as Δt decreases, the direction of $\Delta \mathbf{v}$ changes and consequently, the direction of the acceleration changes. Finally, in the limit $\Delta t \rightarrow 0$ [Fig. 3.15(d)], the average acceleration becomes the instantaneous acceleration and has the direction as shown.

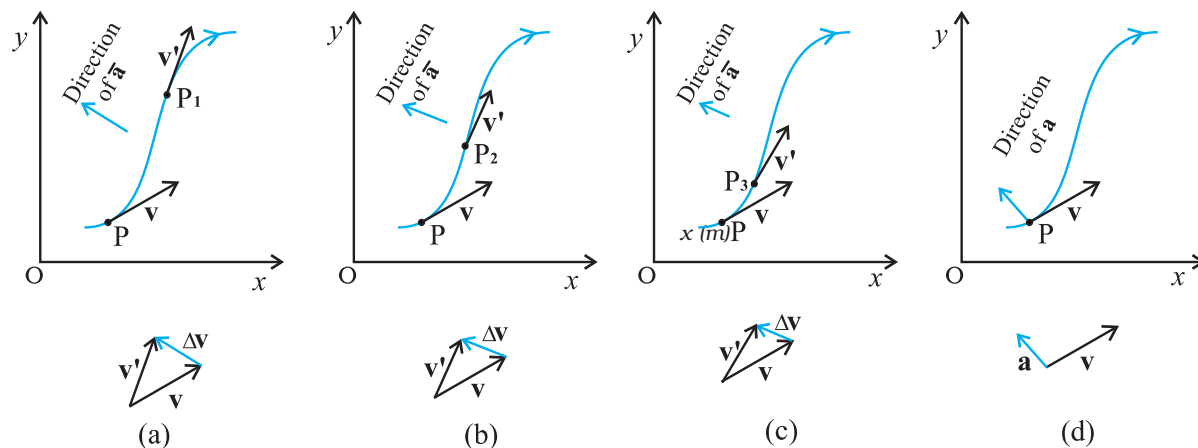

Fig. 3.15 The average acceleration for three time intervals (a) Δt_1 , (b) Δt_2 , and (c) Δt_3 , ($\Delta t_1 > \Delta t_2 > \Delta t_3$). (d) In the limit $\Delta t \rightarrow 0$, the average acceleration becomes the acceleration.

Note that in one dimension, the velocity and the acceleration of an object are always along the same straight line (either in the same direction or in the opposite direction). However, for motion in two or three dimensions, velocity and acceleration vectors may have any angle between 0° and 180° between them.

► **Example 3.4** The position of a particle is given by

$$\mathbf{r} = 3.0t \hat{i} + 2.0t^2 \hat{j} + 5.0 \hat{k}$$

where t is in seconds and the coefficients have the proper units for \mathbf{r} to be in metres. (a) Find $\mathbf{v}(t)$ and $\mathbf{a}(t)$ of the particle. (b) Find the magnitude and direction of $\mathbf{v}(t)$ at $t = 1.0$ s.

Answer

$$\mathbf{v}(t) = \frac{d\mathbf{r}}{dt} = \frac{d}{dt} (3.0t \hat{i} + 2.0t^2 \hat{j} + 5.0 \hat{k})$$

$$= 3.0 \hat{i} + 4.0t \hat{j}$$

$$\mathbf{a}(t) = \frac{d\mathbf{v}}{dt} = +4.0 \hat{j}$$

$$a = 4.0 \text{ m s}^{-2} \text{ along } y\text{-direction}$$

$$\text{At } t = 1.0 \text{ s, } \mathbf{v} = 3.0 \hat{i} + 4.0 \hat{j}$$

It's magnitude is $v = \sqrt{3^2 + 4^2} = 5.0 \text{ m s}^{-1}$
and direction is

$$\theta = \tan^{-1} \left(\frac{v_y}{v_x} \right) = \tan^{-1} \left(\frac{4}{3} \right) \cong 53^\circ \text{ with } x\text{-axis.}$$

3.8 MOTION IN A PLANE WITH CONSTANT ACCELERATION

Suppose that an object is moving in x - y plane and its acceleration \mathbf{a} is constant. Over an interval of time, the average acceleration will equal this constant value. Now, let the velocity of the object be \mathbf{v}_0 at time $t = 0$ and \mathbf{v} at time t .

Then, by definition

$$\mathbf{a} = \frac{\mathbf{v} - \mathbf{v}_0}{t - 0} = \frac{\mathbf{v} - \mathbf{v}_0}{t}$$

$$\text{Or, } \mathbf{v} = \mathbf{v}_0 + \mathbf{a}t \quad (3.33a)$$

In terms of components :

$$v_x = v_{0x} + a_x t$$

$$v_y = v_{0y} + a_y t \quad (3.33b)$$

Let us now find how the position \mathbf{r} changes with time. We follow the method used in the one-dimensional case. Let \mathbf{r}_0 and \mathbf{r} be the position vectors of the particle at time 0 and t and let the velocities at these instants be \mathbf{v}_0 and \mathbf{v} . Then, over this time interval t , the average velocity is $(\mathbf{v}_0 + \mathbf{v})/2$. The displacement is the average velocity multiplied by the time interval :

$$\begin{aligned} \mathbf{r} - \mathbf{r}_0 &= \left(\frac{\mathbf{v} + \mathbf{v}_0}{2} \right) t = \left(\frac{(\mathbf{v}_0 + \mathbf{a}t) + \mathbf{v}_0}{2} \right) t \\ &= \mathbf{v}_0 t + \frac{1}{2} \mathbf{a} t^2 \end{aligned}$$

$$\text{Or, } \mathbf{r} = \mathbf{r}_0 + \mathbf{v}_0 t + \frac{1}{2} \mathbf{a} t^2 \quad (3.34a)$$

It can be easily verified that the derivative of Eq. (3.34a), i.e. $\frac{d\mathbf{r}}{dt}$ gives Eq.(3.33a) and it also satisfies the condition that at $t=0$, $\mathbf{r} = \mathbf{r}_0$. Equation (3.34a) can be written in component form as

$$\begin{aligned} x &= x_0 + v_{0x}t + \frac{1}{2} a_x t^2 \\ y &= y_0 + v_{0y}t + \frac{1}{2} a_y t^2 \end{aligned} \quad (3.34b)$$

One immediate interpretation of Eq.(3.34b) is that the motions in x - and y -directions can be treated independently of each other. That is, **motion in a plane (two-dimensions) can be treated as two separate simultaneous one-dimensional motions with constant acceleration along two perpendicular directions**. This is an important result and is useful in analysing motion of objects in two dimensions. A similar result holds for three dimensions. The choice of perpendicular directions is convenient in many physical situations, as we shall see in section 3.9 for projectile motion.

Example 3.5 A particle starts from origin at $t = 0$ with a velocity $5.0 \hat{i}$ m/s and moves in x - y plane under action of a force which produces a constant acceleration of $(3.0\hat{i} + 2.0\hat{j})$ m/s². (a) What is the y -coordinate of the particle at the instant its x -coordinate is 84 m? (b) What is the speed of the particle at this time?

Answer From Eq. (3.34a) for $\mathbf{r}_0 = 0$, the position of the particle is given by

$$\begin{aligned} \mathbf{r}(t) &= \mathbf{v}_0 t + \frac{1}{2} \mathbf{a} t^2 \\ &= 5.0\hat{i}t + (1/2)(3.0\hat{i} + 2.0\hat{j})t^2 \end{aligned}$$

$$= (5.0t + 1.5t^2)\hat{i} + 1.0t^2\hat{j}$$

$$\text{Therefore, } x(t) = 5.0t + 1.5t^2$$

$$y(t) = 1.0t^2$$

$$\text{Given } x(t) = 84 \text{ m, } t = ?$$

$$5.0t + 1.5t^2 = 84 \Rightarrow t = 6 \text{ s}$$

$$\text{At } t = 6 \text{ s, } y = 1.0(6)^2 = 36.0 \text{ m}$$

$$\text{Now, the velocity } \mathbf{v} = \frac{d\mathbf{r}}{dt} = (5.0 + 3.0t)\hat{i} + 2.0t\hat{j}$$

$$\text{At } t = 6 \text{ s, } \mathbf{v} = 23.0\hat{i} + 12.0\hat{j}$$

$$\text{speed} = |\mathbf{v}| = \sqrt{23^2 + 12^2} \approx 26 \text{ m s}^{-1}$$

3.9 PROJECTILE MOTION

As an application of the ideas developed in the previous sections, we consider the motion of a projectile. An object that is in flight after being thrown or projected is called a **projectile**. Such a projectile might be a football, a cricket ball, a baseball or any other object. The motion of a projectile may be thought of as the result of two separate, simultaneously occurring components of motions. One component is along a horizontal direction without any acceleration and the other along the vertical direction with constant acceleration due to the force of gravity. It was Galileo who first stated this independency of the horizontal and the vertical components of projectile motion in his **Dialogue on the great world systems** (1632).

In our discussion, we shall assume that the air resistance has negligible effect on the motion of the projectile. Suppose that the projectile is launched with velocity \mathbf{v}_0 that makes an angle θ_0 with the x -axis as shown in Fig. 3.16.

After the object has been projected, the acceleration acting on it is that due to gravity which is directed vertically downward:

$$\mathbf{a} = -g\hat{j}$$

$$\text{Or, } a_x = 0, a_y = -g \quad (3.35)$$

The components of initial velocity \mathbf{v}_0 are :

$$\begin{aligned} v_{0x} &= v_0 \cos \theta_0 \\ v_{0y} &= v_0 \sin \theta_0 \end{aligned} \quad (3.36)$$

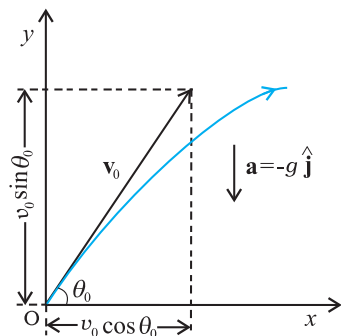

Fig 3.16 Motion of an object projected with velocity v_0 at angle θ_0 .

If we take the initial position to be the origin of the reference frame as shown in Fig. 3.16, we have :

$$x_0 = 0, y_0 = 0$$

Then, Eq.(3.34b) becomes :

$$\begin{aligned} x &= v_{0x} t = (v_0 \cos \theta_0) t \\ \text{and } y &= (v_0 \sin \theta_0) t - \left(\frac{1}{2}\right) g t^2 \end{aligned} \quad (3.37)$$

The components of velocity at time t can be obtained using Eq.(3.33b) :

$$\begin{aligned} v_x &= v_{0x} = v_0 \cos \theta_0 \\ v_y &= v_0 \sin \theta_0 - g t \end{aligned} \quad (3.38)$$

Equation (3.37) gives the x -, and y -coordinates of the position of a projectile at time t in terms of two parameters — initial speed v_0 and projection angle θ_0 . Notice that the choice of mutually perpendicular x -, and y -directions for the analysis of the projectile motion has resulted in a simplification. One of the components of velocity, i.e. x -component remains constant throughout the motion and only the y - component changes, like an object in free fall in vertical direction. This is shown graphically at few instants in Fig. 3.17. Note that at the point of maximum height, $v_y = 0$ and therefore,

$$\theta = \tan^{-1} \frac{v_y}{v_x} = 0$$

Equation of path of a projectile

What is the shape of the path followed by the projectile? This can be seen by eliminating the time between the expressions for x and y as given in Eq. (3.37). We obtain:

$$y = (\tan \theta_0) x - \frac{g}{2 (v_0 \cos \theta_0)^2} x^2 \quad (3.39)$$

Now, since g , θ_0 and v_0 are constants, Eq. (3.39) is of the form $y = a x + b x^2$, in which a and b are constants. This is the equation of a parabola, i.e. the path of the projectile is a parabola (Fig. 3.17).

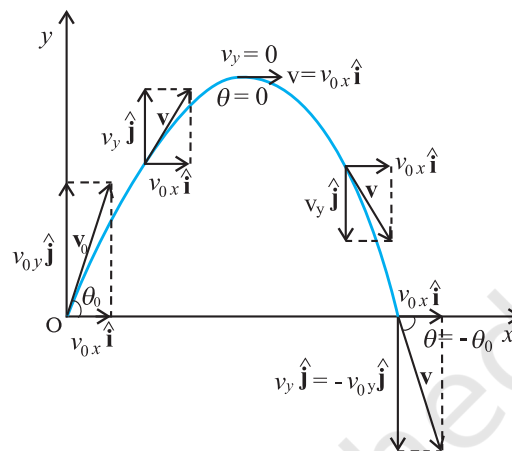

Fig. 3.17 The path of a projectile is a parabola.

Time of maximum height

How much time does the projectile take to reach the maximum height? Let this time be denoted by t_m . Since at this point, $v_y = 0$, we have from Eq. (3.38):

$$\begin{aligned} v_y &= v_0 \sin \theta_0 - g t_m = 0 \\ \text{Or, } t_m &= v_0 \sin \theta_0 / g \end{aligned} \quad (3.40a)$$

The total time T_f during which the projectile is in flight can be obtained by putting $y = 0$ in Eq. (3.37). We get :

$$T_f = 2 (v_0 \sin \theta_0) / g \quad (3.40b)$$

T_f is known as the **time of flight** of the projectile. We note that $T_f = 2 t_m$, which is expected because of the symmetry of the parabolic path.

Maximum height of a projectile

The maximum height h_m reached by the projectile can be calculated by substituting $t = t_m$ in Eq. (3.37) :

$$\begin{aligned} y &= h_m = (v_0 \sin \theta_0) \left(\frac{v_0 \sin \theta_0}{g} \right) - \frac{g}{2} \left(\frac{v_0 \sin \theta_0}{g} \right)^2 \\ \text{Or, } h_m &= \frac{(v_0 \sin \theta_0)^2}{2g} \end{aligned} \quad (3.41)$$

Horizontal range of a projectile

The horizontal distance travelled by a projectile from its initial position ($x = y = 0$) to the position where it passes $y = 0$ during its fall is called the **horizontal**

range, R . It is the distance travelled during the time of flight T_f . Therefore, the range R is

$$R = (v_o \cos \theta_o) (T_f) \\ = (v_o \cos \theta_o) (2 v_o \sin \theta_o) / g$$

$$\text{Or, } R = \frac{v_o^2 \sin 2\theta_o}{g} \quad (3.42a)$$

Equation (3.42a) shows that for a given projection velocity v_o , R is maximum when $\sin 2\theta_o$ is maximum, i.e., when $\theta_o = 45^\circ$.

The maximum horizontal range is, therefore,

$$R_m = \frac{v_o^2}{g} \quad (3.42b)$$

Example 3.6 Galileo, in his book *Two new sciences*, stated that “for elevations which exceed or fall short of 45° by equal amounts, the ranges are equal”. Prove this statement.

Answer For a projectile launched with velocity v_o at an angle θ_o , the range is given by

$$R = \frac{v_o^2 \sin 2\theta_o}{g}$$

Now, for angles, $(45^\circ + \alpha)$ and $(45^\circ - \alpha)$, $2\theta_o$ is $(90^\circ + 2\alpha)$ and $(90^\circ - 2\alpha)$, respectively. The values of $\sin(90^\circ + 2\alpha)$ and $\sin(90^\circ - 2\alpha)$ are the same, equal to that of $\cos 2\alpha$. Therefore, ranges are equal for elevations which exceed or fall short of 45° by equal amounts α .

Example 3.7 A hiker stands on the edge of a cliff 490 m above the ground and throws a stone horizontally with an initial speed of 15 m s^{-1} . Neglecting air resistance, find the time taken by the stone to reach the ground, and the speed with which it hits the ground. (Take $g = 9.8 \text{ m s}^{-2}$).

Answer We choose the origin of the x - and y -axis at the edge of the cliff and $t = 0 \text{ s}$ at the instant the stone is thrown. Choose the positive direction of x -axis to be along the initial velocity and the positive direction of y -axis to be the vertically upward direction. The x - and y -components of the motion can be treated independently. The equations of motion are :

$$x(t) = x_o + v_{ox} t$$

$$y(t) = y_o + v_{oy} t + (1/2) a_y t^2 \\ \text{Here, } x_o = y_o = 0, v_{oy} = 0, a_y = -g = -9.8 \text{ m s}^{-2}, \\ v_{ox} = 15 \text{ m s}^{-1}.$$

The stone hits the ground when $y(t) = -490 \text{ m}$.
 $-490 \text{ m} = -(1/2)(9.8) t^2$.

This gives $t = 10 \text{ s}$.

The velocity components are $v_x = v_{ox}$ and

$$v_y = v_{oy} - g t$$

so that when the stone hits the ground :

$$v_{ox} = 15 \text{ m s}^{-1}$$

$$v_{oy} = 0 - 9.8 \cdot 10 = -98 \text{ m s}^{-1}$$

Therefore, the speed of the stone is

$$\sqrt{v_x^2 + v_y^2} = \sqrt{15^2 + 98^2} = 99 \text{ m s}^{-1}$$

Example 3.8 A cricket ball is thrown at a speed of 28 m s^{-1} in a direction 30° above the horizontal. Calculate (a) the maximum height, (b) the time taken by the ball to return to the same level, and (c) the distance from the thrower to the point where the ball returns to the same level.

Answer (a) The maximum height is given by

$$h_m = \frac{(v_o \sin \theta_o)^2}{2g} = \frac{(28 \sin 30^\circ)^2}{2(9.8)} \text{ m} \\ = \frac{14 \times 14}{2 \times 9.8} = 10.0 \text{ m}$$

(b) The time taken to return to the same level is
 $T_f = (2 v_o \sin \theta_o) / g = (2 \cdot 28 \cdot \sin 30^\circ) / 9.8$
 $= 28 / 9.8 \text{ s} = 2.9 \text{ s}$

(c) The distance from the thrower to the point where the ball returns to the same level is

$$R = \frac{(v_o^2 \sin 2\theta_o)}{g} = \frac{28 \times 28 \times \sin 60^\circ}{9.8} = 69 \text{ m}$$

3.10 UNIFORM CIRCULAR MOTION

When an object follows a circular path at a constant speed, the motion of the object is called **uniform circular motion**. The word “uniform” refers to the speed, which is uniform (constant) throughout the motion. Suppose an object is moving with uniform speed v in a circle of radius R as shown in Fig. 3.18. Since the velocity of the object is changing continuously in direction, the object undergoes acceleration. Let us find the magnitude and the direction of this acceleration.

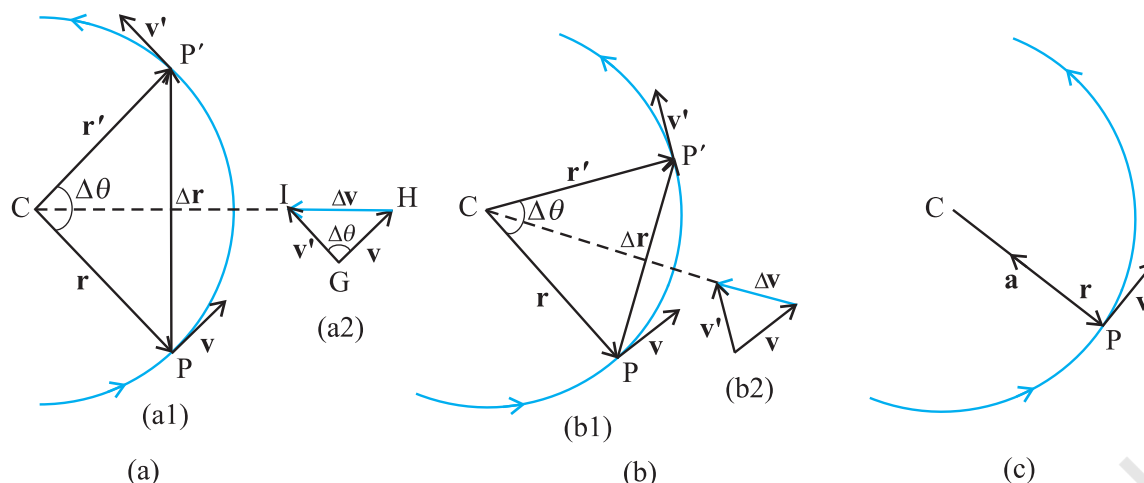

Fig. 3.18 Velocity and acceleration of an object in uniform circular motion. The time interval Δt decreases from (a) to (c) where it is zero. The acceleration is directed, at each point of the path, towards the centre of the circle.

Let \mathbf{r} and \mathbf{r}' be the position vectors and \mathbf{v} and \mathbf{v}' the velocities of the object when it is at point P and P' as shown in Fig. 3.18(a). By definition, velocity at a point is along the tangent at that point in the direction of motion. The velocity vectors \mathbf{v} and \mathbf{v}' are as shown in Fig. 3.18(a1). $\Delta\mathbf{v}$ is obtained in Fig. 3.18(a2) using the triangle law of vector addition. Since the path is circular, \mathbf{v} is perpendicular to \mathbf{r} and so is \mathbf{v}' to \mathbf{r}' . Therefore, $\Delta\mathbf{v}$ is perpendicular to $\Delta\mathbf{r}$. Since

average acceleration is along $\Delta\mathbf{v}$ $\left(\bar{\mathbf{a}} = \frac{\Delta\mathbf{v}}{\Delta t}\right)$, the

average acceleration $\bar{\mathbf{a}}$ is perpendicular to $\Delta\mathbf{r}$. If we place $\Delta\mathbf{v}$ on the line that bisects the angle between \mathbf{r} and \mathbf{r}' , we see that it is directed towards the centre of the circle. Figure 3.18(b) shows the same quantities for smaller time interval. $\Delta\mathbf{v}$ and hence $\bar{\mathbf{a}}$ is again directed towards the centre. In Fig. 3.18(c), $\Delta t \rightarrow 0$ and the average acceleration becomes the instantaneous acceleration. It is directed towards the centre*. Thus, we find that the acceleration of an object in uniform circular motion is always directed towards the centre of the circle. Let us now find the magnitude of the acceleration.

The magnitude of \mathbf{a} is, by definition, given by

$$|\mathbf{a}| = \lim_{\Delta t \rightarrow 0} \frac{|\Delta\mathbf{v}|}{\Delta t}$$

Let the angle between position vectors \mathbf{r} and

\mathbf{r}' be $\Delta\theta$. Since the velocity vectors \mathbf{v} and \mathbf{v}' are always perpendicular to the position vectors, the angle between them is also $\Delta\theta$. Therefore, the triangle CPP' formed by the position vectors and the triangle GHI formed by the velocity vectors \mathbf{v} , \mathbf{v}' and $\Delta\mathbf{v}$ are similar (Fig. 3.18a). Therefore, the ratio of the base-length to side-length for one of the triangles is equal to that of the other triangle. That is :

$$\frac{|\Delta\mathbf{v}|}{v} = \frac{|\Delta\mathbf{r}|}{R}$$

Or, $|\Delta\mathbf{v}| = v \frac{|\Delta\mathbf{r}|}{R}$

Therefore,

$$|\mathbf{a}| = \lim_{\Delta t \rightarrow 0} \frac{|\Delta\mathbf{v}|}{\Delta t} = \lim_{\Delta t \rightarrow 0} \frac{v|\Delta\mathbf{r}|}{R\Delta t} = \frac{v}{R} \lim_{\Delta t \rightarrow 0} \frac{|\Delta\mathbf{r}|}{\Delta t}$$

If Δt is small, $\Delta\theta$ will also be small and then arc PP' can be approximately taken to be $|\Delta\mathbf{r}|$:

$$|\Delta\mathbf{r}| \cong v\Delta t$$

$$\frac{|\Delta\mathbf{r}|}{\Delta t} \cong v$$

Or, $\lim_{\Delta t \rightarrow 0} \frac{|\Delta\mathbf{r}|}{\Delta t} = v$

Therefore, the centripetal acceleration a_c is :

* In the limit $\Delta t \rightarrow 0$, $\Delta\mathbf{r}$ becomes perpendicular to \mathbf{r} . In this limit $\Delta\mathbf{v} \rightarrow \mathbf{0}$ and is consequently also perpendicular to \mathbf{v} . Therefore, the acceleration is directed towards the centre, at each point of the circular path.

$$a_c = \left(\frac{v}{R} \right) v = v^2/R \quad (3.43)$$

Thus, the acceleration of an object moving with speed v in a circle of radius R has a magnitude v^2/R and is always **directed towards the centre**. This is why this acceleration is called **centripetal acceleration** (a term proposed by Newton). A thorough analysis of centripetal acceleration was first published in 1673 by the Dutch scientist Christiaan Huygens (1629-1695) but it was probably known to Newton also some years earlier. "Centripetal" comes from a Greek term which means 'centre-seeking'. Since v and R are constant, the magnitude of the centripetal acceleration is also constant. However, the direction changes — pointing always towards the centre. Therefore, a centripetal acceleration is not a constant vector.

We have another way of describing the velocity and the acceleration of an object in uniform circular motion. As the object moves from P to P' in time $\Delta t (= t' - t)$, the line CP (Fig. 3.18) turns through an angle $\Delta\theta$ as shown in the figure. $\Delta\theta$ is called angular distance. We define the angular speed ω (Greek letter omega) as the time rate of change of angular displacement :

$$\omega = \frac{\Delta\theta}{\Delta t} \quad (3.44)$$

Now, if the distance travelled by the object during the time Δt is Δs , i.e. PP' is Δs , then :

$$v = \frac{\Delta s}{\Delta t}$$

but $\Delta s = R\Delta\theta$. Therefore :

$$v = R \frac{\Delta\theta}{\Delta t} = R \omega$$

$$v = R \omega \quad (3.45)$$

We can express centripetal acceleration a_c in terms of angular speed :

$$a_c = \frac{v^2}{R} = \frac{\omega^2 R^2}{R} = \omega^2 R$$

$$a_c = \omega^2 R \quad (3.46)$$

The time taken by an object to make one revolution is known as its time period T and the number of revolution made in one second is called its frequency $\nu (=1/T)$. However, during this time the distance moved by the object is $s = 2\pi R$.

$$\text{Therefore, } v = 2\pi R/T = 2\pi R\nu \quad (3.47)$$

In terms of frequency ν , we have

$$\omega = 2\pi\nu$$

$$v = 2\pi R\nu$$

$$a_c = 4\pi^2 \nu^2 R \quad (3.48)$$

► **Example 3.9** An insect trapped in a circular groove of radius 12 cm moves along the groove steadily and completes 7 revolutions in 100 s. (a) What is the angular speed, and the linear speed of the motion? (b) Is the acceleration vector a constant vector? What is its magnitude?

Answer This is an example of uniform circular motion. Here $R = 12$ cm. The angular speed ω is given by

$$\omega = 2\pi/T = 2\pi \cdot 7/100 = 0.44 \text{ rad/s}$$

The linear speed v is :

$$v = \omega R = 0.44 \text{ s}^{-1} \cdot 12 \text{ cm} = 5.3 \text{ cm s}^{-1}$$

The direction of velocity \mathbf{v} is along the tangent to the circle at every point. The acceleration is directed towards the centre of the circle. Since this direction changes continuously, acceleration here is *not* a constant vector. However, the magnitude of acceleration is constant:

$$a = \omega^2 R = (0.44 \text{ s}^{-1})^2 (12 \text{ cm})$$

$$= 2.3 \text{ cm s}^{-2} \quad \blacktriangleleft$$

SUMMARY

1. *Scalar quantities* are quantities with magnitudes only. Examples are distance, speed, mass and temperature.
2. *Vector quantities* are quantities with magnitude and direction both. Examples are displacement, velocity and acceleration. They obey special rules of vector algebra.
3. A vector \mathbf{A} multiplied by a real number λ is also a vector, whose magnitude is λ times the magnitude of the vector \mathbf{A} and whose direction is the same or opposite depending upon whether λ is positive or negative.
4. Two vectors \mathbf{A} and \mathbf{B} may be *added graphically* using *head-to-tail method* or *parallelogram method*.

5. Vector addition is *commutative* :

$$\mathbf{A} + \mathbf{B} = \mathbf{B} + \mathbf{A}$$

It also obeys the *associative law* :

$$(\mathbf{A} + \mathbf{B}) + \mathbf{C} = \mathbf{A} + (\mathbf{B} + \mathbf{C})$$

6. A *null* or *zero vector* is a vector with zero magnitude. Since the magnitude is zero, we don't have to specify its direction. It has the properties :

$$\mathbf{A} + \mathbf{0} = \mathbf{A}$$

$$\lambda \mathbf{0} = \mathbf{0}$$

$$0 \mathbf{A} = \mathbf{0}$$

7. The *subtraction* of vector \mathbf{B} from \mathbf{A} is defined as the sum of \mathbf{A} and $-\mathbf{B}$:

$$\mathbf{A} - \mathbf{B} = \mathbf{A} + (-\mathbf{B})$$

8. A vector \mathbf{A} can be *resolved* into component along two given vectors \mathbf{a} and \mathbf{b} lying in the same plane :

$$\mathbf{A} = \lambda \mathbf{a} + \mu \mathbf{b}$$

where λ and μ are real numbers.

9. A *unit vector* associated with a vector \mathbf{A} has magnitude 1 and is along the vector \mathbf{A} :

$$\hat{\mathbf{n}} = \frac{\mathbf{A}}{|\mathbf{A}|}$$

The unit vectors $\hat{\mathbf{i}}, \hat{\mathbf{j}}, \hat{\mathbf{k}}$ are vectors of unit magnitude and point in the direction of the x -, y -, and z -axes, respectively in a right-handed coordinate system.

10. A vector \mathbf{A} can be expressed as

$$\mathbf{A} = A_x \hat{\mathbf{i}} + A_y \hat{\mathbf{j}}$$

where A_x, A_y are its components along x -, and y -axes. If vector \mathbf{A} makes an angle θ

with the x -axis, then $A_x = A \cos \theta, A_y = A \sin \theta$ and $A = |\mathbf{A}| = \sqrt{A_x^2 + A_y^2}, \tan \theta = \frac{A_y}{A_x}$.

11. Vectors can be conveniently added using *analytical method*. If sum of two vectors \mathbf{A} and \mathbf{B} , that lie in x - y plane, is \mathbf{R} , then :

$$\mathbf{R} = R_x \hat{\mathbf{i}} + R_y \hat{\mathbf{j}}, \text{ where, } R_x = A_x + B_x \text{ and } R_y = A_y + B_y$$

12. The *position vector* of an object in x - y plane is given by $\mathbf{r} = x \hat{\mathbf{i}} + y \hat{\mathbf{j}}$ and the *displacement* from position \mathbf{r} to position \mathbf{r}' is given by

$$\Delta \mathbf{r} = \mathbf{r}' - \mathbf{r}$$

$$= (x' - x) \hat{\mathbf{i}} + (y' - y) \hat{\mathbf{j}}$$

$$= \Delta x \hat{\mathbf{i}} + \Delta y \hat{\mathbf{j}}$$

13. If an object undergoes a displacement $\Delta \mathbf{r}$ in time Δt , its *average velocity* is given by

$\mathbf{v} = \frac{\Delta \mathbf{r}}{\Delta t}$. The *velocity* of an object at time t is the limiting value of the average velocity

as Δt tends to zero :

$\mathbf{v} = \lim_{\Delta t \rightarrow 0} \frac{\Delta \mathbf{r}}{\Delta t} = \frac{d\mathbf{r}}{dt}$. It can be written in unit vector notation as :

$$\mathbf{v} = v_x \hat{\mathbf{i}} + v_y \hat{\mathbf{j}} + v_z \hat{\mathbf{k}} \quad \text{where} \quad v_x = \frac{dx}{dt}, v_y = \frac{dy}{dt}, v_z = \frac{dz}{dt}$$

When position of an object is plotted on a coordinate system, \mathbf{v} is always tangent to the curve representing the path of the object.

14. If the velocity of an object changes from \mathbf{v} to \mathbf{v}' in time Δt , then its *average acceleration*

is given by:
$$\bar{\mathbf{a}} = \frac{\mathbf{v} - \mathbf{v}'}{\Delta t} = \frac{\Delta \mathbf{v}}{\Delta t}$$

The *acceleration* \mathbf{a} at any time t is the limiting value of $\bar{\mathbf{a}}$ as $\Delta t \rightarrow 0$:

$$\mathbf{a} = \lim_{\Delta t \rightarrow 0} \frac{\Delta \mathbf{v}}{\Delta t} = \frac{d\mathbf{v}}{dt}$$

In component form, we have : $\mathbf{a} = a_x \hat{\mathbf{i}} + a_y \hat{\mathbf{j}} + a_z \hat{\mathbf{k}}$

where, $a_x = \frac{dv_x}{dt}$, $a_y = \frac{dv_y}{dt}$, $a_z = \frac{dv_z}{dt}$

15. If an object is moving in a plane with constant acceleration $a = |\mathbf{a}| = \sqrt{a_x^2 + a_y^2}$ and its position vector at time $t = 0$ is \mathbf{r}_0 , then at any other time t , it will be at a point given by:

$$\mathbf{r} = \mathbf{r}_0 + \mathbf{v}_0 t + \frac{1}{2} \mathbf{a} t^2$$

and its velocity is given by :

$$\mathbf{v} = \mathbf{v}_0 + \mathbf{a} t$$

where \mathbf{v}_0 is the velocity at time $t = 0$

In component form :

$$x = x_0 + v_{0x} t + \frac{1}{2} a_x t^2$$

$$y = y_0 + v_{0y} t + \frac{1}{2} a_y t^2$$

$$v_x = v_{0x} + a_x t$$

$$v_y = v_{0y} + a_y t$$

Motion in a plane can be treated as superposition of two separate simultaneous one-dimensional motions along two perpendicular directions

16. An object that is in flight after being projected is called a *projectile*. If an object is projected with initial velocity \mathbf{v}_0 making an angle θ_0 with x -axis and if we assume its initial position to coincide with the origin of the coordinate system, then the position and velocity of the projectile at time t are given by :

$$x = (v_0 \cos \theta_0) t$$

$$y = (v_0 \sin \theta_0) t - (1/2) g t^2$$

$$v_x = v_{0x} = v_0 \cos \theta_0$$

$$v_y = v_0 \sin \theta_0 - g t$$

The path of a projectile is *parabolic* and is given by :

$$y = (\tan \theta_0) x - \frac{g x^2}{2 (v_0 \cos \theta_0)^2}$$

The *maximum height* that a projectile attains is :

$$h_m = \frac{(v_o \sin \theta_o)^2}{2g}$$

The *time* taken to reach this height is :

$$t_m = \frac{v_o \sin \theta_o}{g}$$

The horizontal distance travelled by a projectile from its initial position to the position it passes $y = 0$ during its fall is called the *range*, R of the projectile. It is :

$$R = \frac{v_o^2}{g} \sin 2\theta_o$$

17. When an object follows a circular path at constant speed, the motion of the object is called *uniform circular motion*. The magnitude of its acceleration is $a_c = v^2/R$. The direction of a_c is always towards the centre of the circle.

The angular speed ω , is the rate of change of angular distance. It is related to velocity v by $v = \omega R$. The acceleration is $a_c = \omega^2 R$.

If T is the time period of revolution of the object in circular motion and ν is its frequency, we have $\omega = 2\pi \nu$, $v = 2\pi \nu R$, $a_c = 4\pi^2 \nu^2 R$

| Physical Quantity | Symbol | Dimensions | Unit | Remark |
|------------------------------|---------------------|---------------------|-------------------|--|
| Position vector | \mathbf{r} | [L] | m | Vector. It may be denoted by any other symbol as well. |
| Displacement | $\Delta \mathbf{r}$ | [L] | m | - do - |
| Velocity | | [LT ⁻¹] | m s ⁻¹ | |
| (a) Average | $\bar{\mathbf{v}}$ | | | $= \frac{\Delta \mathbf{r}}{\Delta t}$, vector |
| (b) Instantaneous | \mathbf{v} | | | $= \frac{d\mathbf{r}}{dt}$, vector |
| Acceleration | | [LT ⁻²] | m s ⁻² | |
| (a) Average | $\bar{\mathbf{a}}$ | | | $= \frac{\Delta \mathbf{v}}{\Delta t}$, vector |
| (b) Instantaneous | \mathbf{a} | | | $= \frac{d\mathbf{v}}{dt}$, vector |
| Projectile motion | | | | |
| (a) Time of max. height | t_m | [T] | s | $= \frac{v_o \sin \theta_o}{g}$ |
| (b) Max. height | h_m | [L] | m | $= \frac{(v_o \sin \theta_o)^2}{2g}$ |
| (c) Horizontal range | R | [L] | m | $= \frac{v_o^2 \sin 2\theta_o}{g}$ |
| Circular motion | | | | |
| (a) Angular speed | ω | [T ⁻¹] | rad/s | $= \frac{\Delta \theta}{\Delta t} = \frac{v}{r}$ |
| (b) Centripetal acceleration | a_c | [LT ⁻²] | m s ⁻² | $= \frac{v^2}{r}$ |

POINTS TO PONDER

1. The path length traversed by an object between two points is, in general, not the same as the magnitude of displacement. The displacement depends only on the end points; the path length (as the name implies) depends on the actual path. The two quantities are equal only if the object does not change its direction during the course of motion. In all other cases, the path length is greater than the magnitude of displacement.
2. In view of point 1 above, the average speed of an object is greater than or equal to the magnitude of the average velocity over a given time interval. The two are equal only if the path length is equal to the magnitude of displacement.
3. The vector equations (3.33a) and (3.34a) do not involve any choice of axes. Of course, you can always resolve them along any two independent axes.
4. The kinematic equations for uniform acceleration do not apply to the case of uniform circular motion since in this case the magnitude of acceleration is constant but its direction is changing.
5. An object subjected to two velocities \mathbf{v}_1 and \mathbf{v}_2 has a resultant velocity $\mathbf{v} = \mathbf{v}_1 + \mathbf{v}_2$. Take care to distinguish it from velocity of object 1 relative to velocity of object 2 : $\mathbf{v}_{12} = \mathbf{v}_1 - \mathbf{v}_2$. Here \mathbf{v}_1 and \mathbf{v}_2 are velocities with reference to some common reference frame.
6. The resultant acceleration of an object in circular motion is towards the centre only if the speed is constant.
7. The shape of the trajectory of the motion of an object is not determined by the acceleration alone but also depends on the initial conditions of motion (initial position and initial velocity). For example, the trajectory of an object moving under the same acceleration due to gravity can be a straight line or a parabola depending on the initial conditions.

EXERCISES

- 3.1 State, for each of the following physical quantities, if it is a scalar or a vector : volume, mass, speed, acceleration, density, number of moles, velocity, angular frequency, displacement, angular velocity.
- 3.2 Pick out the two scalar quantities in the following list : force, angular momentum, work, current, linear momentum, electric field, average velocity, magnetic moment, relative velocity.
- 3.3 Pick out the only vector quantity in the following list : Temperature, pressure, impulse, time, power, total path length, energy, gravitational potential, coefficient of friction, charge.
- 3.4 State with reasons, whether the following algebraic operations with scalar and vector physical quantities are meaningful :
(a) adding any two scalars, (b) adding a scalar to a vector of the same dimensions ,
(c) multiplying any vector by any scalar, (d) multiplying any two scalars, (e) adding any two vectors, (f) adding a component of a vector to the same vector.
- 3.5 Read each statement below carefully and state with reasons, if it is true or false :
(a) The magnitude of a vector is always a scalar, (b) each component of a vector is always a scalar, (c) the total path length is always equal to the magnitude of the displacement vector of a particle. (d) the average speed of a particle (defined as total path length divided by the time taken to cover the path) is either greater or equal to the magnitude of average velocity of the particle over the same interval of time, (e) Three vectors not lying in a plane can never add up to give a null vector.
- 3.6 Establish the following vector inequalities geometrically or otherwise :
(a) $|\mathbf{a} + \mathbf{b}| \leq |\mathbf{a}| + |\mathbf{b}|$
(b) $|\mathbf{a} + \mathbf{b}| \geq ||\mathbf{a}| - |\mathbf{b}||$

- (c) $|\mathbf{a}-\mathbf{b}| \leq |\mathbf{a}| + |\mathbf{b}|$
 (d) $|\mathbf{a}-\mathbf{b}| \geq ||\mathbf{a}| - |\mathbf{b}||$

When does the equality sign above apply?

- 3.7** Given $\mathbf{a} + \mathbf{b} + \mathbf{c} + \mathbf{d} = \mathbf{0}$, which of the following statements are correct :
- (a) \mathbf{a} , \mathbf{b} , \mathbf{c} , and \mathbf{d} must each be a null vector,
 (b) The magnitude of $(\mathbf{a} + \mathbf{c})$ equals the magnitude of $(\mathbf{b} + \mathbf{d})$,
 (c) The magnitude of \mathbf{a} can never be greater than the sum of the magnitudes of \mathbf{b} , \mathbf{c} , and \mathbf{d} ,
 (d) $\mathbf{b} + \mathbf{c}$ must lie in the plane of \mathbf{a} and \mathbf{d} if \mathbf{a} and \mathbf{d} are not collinear, and in the line of \mathbf{a} and \mathbf{d} , if they are collinear ?

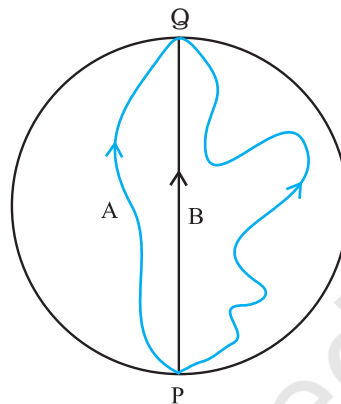

Fig. 3.19

- 3.8** Three girls skating on a circular ice ground of radius 200 m start from a point P on the edge of the ground and reach a point Q diametrically opposite to P following different paths as shown in Fig. 3.19. What is the magnitude of the displacement vector for each ? For which girl is this equal to the actual length of path skate ?

- 3.9** A cyclist starts from the centre O of a circular park of radius 1 km, reaches the edge P of the park, then cycles along the circumference, and returns to the centre along QO as shown in Fig. 3.20. If the round trip takes 10 min, what is the (a) net displacement, (b) average velocity, and (c) average speed of the cyclist ?

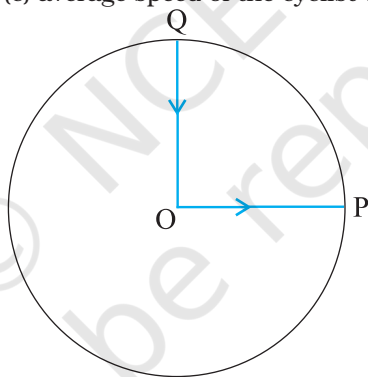

Fig. 3.20

- 3.10** On an open ground, a motorist follows a track that turns to his left by an angle of 60° after every 500 m. Starting from a given turn, specify the displacement of the motorist at the third, sixth and eighth turn. Compare the magnitude of the displacement with the total path length covered by the motorist in each case.
- 3.11** A passenger arriving in a new town wishes to go from the station to a hotel located 10 km away on a straight road from the station. A dishonest cabman takes him along a circuitous path 23 km long and reaches the hotel in 28 min. What is (a) the average speed of the taxi, (b) the magnitude of average velocity ? Are the two equal ?
- 3.12** The ceiling of a long hall is 25 m high. What is the maximum horizontal distance that a ball thrown with a speed of 40 m s^{-1} can go without hitting the ceiling of the hall ?
- 3.13** A cricketer can throw a ball to a maximum horizontal distance of 100 m. How much high above the ground can the cricketer throw the same ball ?

- 3.14** A stone tied to the end of a string 80 cm long is whirled in a horizontal circle with a constant speed. If the stone makes 14 revolutions in 25 s, what is the magnitude and direction of acceleration of the stone ?
- 3.15** An aircraft executes a horizontal loop of radius 1.00 km with a steady speed of 900 km/h. Compare its centripetal acceleration with the acceleration due to gravity.
- 3.16** Read each statement below carefully and state, with reasons, if it is true or false :
- The net acceleration of a particle in circular motion is *always* along the radius of the circle towards the centre
 - The velocity vector of a particle at a point is *always* along the tangent to the path of the particle at that point
 - The acceleration vector of a particle in *uniform* circular motion averaged over one cycle is a null vector

- 3.17** The position of a particle is given by

$$\mathbf{r} = 3.0t \hat{\mathbf{i}} - 2.0t^2 \hat{\mathbf{j}} + 4.0 \hat{\mathbf{k}} \text{ m}$$

where t is in seconds and the coefficients have the proper units for \mathbf{r} to be in metres.

- (a) Find the \mathbf{v} and \mathbf{a} of the particle? (b) What is the magnitude and direction of velocity of the particle at $t = 2.0$ s ?

- 3.18** A particle starts from the origin at $t = 0$ s with a velocity of $10.0 \hat{\mathbf{j}}$ m/s and moves in the x - y plane with a constant acceleration of $(8.0\hat{\mathbf{i}} + 2.0\hat{\mathbf{j}})$ m s⁻². (a) At what time is the x -coordinate of the particle 16 m? What is the y -coordinate of the particle at that time? (b) What is the speed of the particle at the time ?

- 3.19** $\hat{\mathbf{i}}$ and $\hat{\mathbf{j}}$ are unit vectors along x - and y - axis respectively. What is the magnitude and direction of the vectors $\hat{\mathbf{i}} + \hat{\mathbf{j}}$, and $\hat{\mathbf{i}} - \hat{\mathbf{j}}$? What are the components of a vector $\mathbf{A} = 2\hat{\mathbf{i}} + 3\hat{\mathbf{j}}$ along the directions of $\hat{\mathbf{i}} + \hat{\mathbf{j}}$ and $\hat{\mathbf{i}} - \hat{\mathbf{j}}$? [You may use graphical method]

- 3.20** For any arbitrary motion in space, which of the following relations are true :

(a) $\mathbf{v}_{\text{average}} = (1/2) (\mathbf{v}(t_1) + \mathbf{v}(t_2))$

(b) $\mathbf{v}_{\text{average}} = [\mathbf{r}(t_2) - \mathbf{r}(t_1)] / (t_2 - t_1)$

(c) $\mathbf{v}(t) = \mathbf{v}(0) + \mathbf{a} t$

(d) $\mathbf{r}(t) = \mathbf{r}(0) + \mathbf{v}(0) t + (1/2) \mathbf{a} t^2$

(e) $\mathbf{a}_{\text{average}} = [\mathbf{v}(t_2) - \mathbf{v}(t_1)] / (t_2 - t_1)$

(The 'average' stands for average of the quantity over the time interval t_1 to t_2)

- 3.21** Read each statement below carefully and state, with reasons and examples, if it is true or false :

A scalar quantity is one that

- is conserved in a process
- can never take negative values
- must be dimensionless
- does not vary from one point to another in space
- has the same value for observers with different orientations of axes.

- 3.22** An aircraft is flying at a height of 3400 m above the ground. If the angle subtended at a ground observation point by the aircraft positions 10.0 s apart is 30°, what is the speed of the aircraft ?



LAWS OF MOTION

- 4.1 Introduction
- 4.2 Aristotle's fallacy
- 4.3 The law of inertia
- 4.4 Newton's first law of motion
- 4.5 Newton's second law of motion
- 4.6 Newton's third law of motion
- 4.7 Conservation of momentum
- 4.8 Equilibrium of a particle
- 4.9 Common forces in mechanics
- 4.10 Circular motion
- 4.11 Solving problems in mechanics
- Summary
- Points to ponder
- Exercises

4.1 INTRODUCTION

In the preceding Chapter, our concern was to describe the motion of a particle in space quantitatively. We saw that uniform motion needs the concept of velocity alone whereas non-uniform motion requires the concept of acceleration in addition. So far, we have not asked the question as to what governs the motion of bodies. In this chapter, we turn to this basic question.

Let us first guess the answer based on our common experience. To move a football at rest, someone must kick it. To throw a stone upwards, one has to give it an upward push. A breeze causes the branches of a tree to swing; a strong wind can even move heavy objects. A boat moves in a flowing river without anyone rowing it. Clearly, some external agency is needed to provide force to move a body from rest. Likewise, an external force is needed also to retard or stop motion. You can stop a ball rolling down an inclined plane by applying a force against the direction of its motion.

In these examples, the external agency of force (hands, wind, stream, etc) is in contact with the object. This is not always necessary. A stone released from the top of a building accelerates downward due to the gravitational pull of the earth. A bar magnet can attract an iron nail from a distance. **This shows that external agencies (e.g. gravitational and magnetic forces) can exert force on a body even from a distance.**

In short, a force is required to put a stationary body in motion or stop a moving body, and some external agency is needed to provide this force. The external agency may or may not be in contact with the body.

So far so good. But what if a body is moving uniformly (e.g. a skater moving straight with constant speed on a horizontal ice slab)? **Is an external force required to keep a body in uniform motion?**

4.2 ARISTOTLE'S FALLACY

The question posed above appears to be simple. However, it took ages to answer it. Indeed, the correct answer to this question given by Galileo in the seventeenth century was the foundation of Newtonian mechanics, which signalled the birth of modern science.

The Greek thinker, Aristotle (384 B.C– 322 B.C.), held the view that if a body is moving, something external is required to keep it moving. According to this view, for example, an arrow shot from a bow keeps flying since the air behind the arrow keeps pushing it. The view was part of an elaborate framework of ideas developed by Aristotle on the motion of bodies in the universe. Most of the Aristotelian ideas on motion are now known to be wrong and need not concern us. For our purpose here, the Aristotelian law of motion may be phrased thus: **An external force is required to keep a body in motion.**

Aristotelian law of motion is flawed, as we shall see. However, it is a natural view that anyone would hold from common experience. Even a small child playing with a simple (non-electric) toy-car on a floor knows intuitively that it needs to constantly drag the string attached to the toy-car with some force to keep it going. If it releases the string, it comes to rest. This experience is common to most terrestrial motion. External forces seem to be needed to keep bodies in motion. Left to themselves, all bodies eventually come to rest.

What is the flaw in Aristotle's argument? The answer is: a moving toy car comes to rest because the external force of friction on the car by the floor opposes its motion. To counter this force, the child has to apply an external force on the car in the direction of motion. When the car is in uniform motion, there is no net external force acting on it: the force by the child cancels the force (friction) by the floor. The corollary is: if there were no friction, the child would not be required to apply any force to keep the toy car in uniform motion.

The opposing forces such as friction (solids) and viscous forces (for fluids) are always present in the natural world. This explains why forces by external agencies are necessary to overcome the frictional forces to keep bodies in uniform motion. Now we understand where Aristotle went wrong. He coded this practical experience in the form of a basic argument. To get at the

true law of nature for forces and motion, one has to imagine a world in which uniform motion is possible with no frictional forces opposing. This is what Galileo did.

4.3 THE LAW OF INERTIA

Galileo studied motion of objects on an inclined plane. Objects (i) moving down an inclined plane accelerate, while those (ii) moving up retard. (iii) Motion on a horizontal plane is an intermediate situation. Galileo concluded that an object moving on a frictionless horizontal plane must neither have acceleration nor retardation, i.e. it should move with constant velocity (Fig. 4.1(a)).

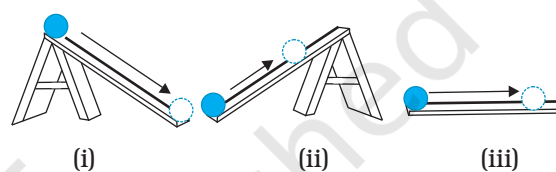

Fig. 4.1(a)

Another experiment by Galileo leading to the same conclusion involves a double inclined plane. A ball released from rest on one of the planes rolls down and climbs up the other. If the planes are smooth, the final height of the ball is nearly the same as the initial height (a little less but never greater). In the ideal situation, when friction is absent, the final height of the ball is the same as its initial height.

If the slope of the second plane is decreased and the experiment repeated, the ball will still reach the same height, but in doing so, it will travel a longer distance. In the limiting case, when the slope of the second plane is zero (i.e. is a horizontal) the ball travels an infinite distance. In other words, its motion never ceases. This is, of course, an idealised situation (Fig. 4.1(b)).

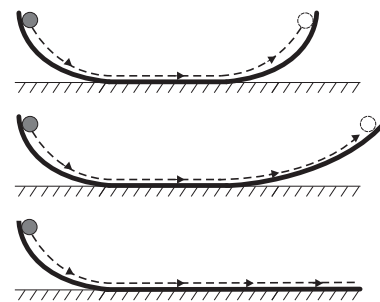

Fig. 4.1(b) The law of inertia was inferred by Galileo from observations of motion of a ball on a double inclined plane.

In practice, the ball does come to a stop after moving a finite distance on the horizontal plane, because of the opposing force of friction which can never be totally eliminated. However, if there were no friction, the ball would continue to move with a constant velocity on the horizontal plane.

Galileo thus, arrived at a new insight on motion that had eluded Aristotle and those who followed him. The state of rest and the state of uniform linear motion (motion with constant velocity) are equivalent. In both cases, there is

accomplished almost single-handedly by Isaac Newton, one of the greatest scientists of all times.

Newton built on Galileo's ideas and laid the foundation of mechanics in terms of three laws of motion that go by his name. Galileo's law of inertia was his starting point which he formulated as the **first law of motion**:

Every body continues to be in its state of rest or of uniform motion in a straight line unless compelled by some external force to act otherwise.

Ideas on Motion in Ancient Indian Science

Ancient Indian thinkers had arrived at an elaborate system of ideas on motion. Force, the cause of motion, was thought to be of different kinds : force due to continuous pressure (nodan), as the force of wind on a sailing vessel; impact (abhigat), as when a potter's rod strikes the wheel; persistent tendency (sanskara) to move in a straight line (vega) or restoration of shape in an elastic body; transmitted force by a string, rod, etc. The notion of (vega) in the Vaisesika theory of motion perhaps comes closest to the concept of inertia. Vega, the tendency to move in a straight line, was thought to be opposed by contact with objects including atmosphere, a parallel to the ideas of friction and air resistance. It was correctly summarised that the different kinds of motion (translational, rotational and vibrational) of an extended body arise from only the translational motion of its constituent particles. A falling leaf in the wind may have downward motion as a whole (patan) and also rotational and vibrational motion (bhraman, spandan), but each particle of the leaf at an instant only has a definite (small) displacement. There was considerable focus in Indian thought on measurement of motion and units of length and time. It was known that the position of a particle in space can be indicated by distance measured along three axes. Bhaskara (1150 A.D.) had introduced the concept of 'instantaneous motion' (*tatkaliki gati*), which anticipated the modern notion of instantaneous velocity using Differential Calculus. The difference between a wave and a current (of water) was clearly understood; a current is a motion of particles of water under gravity and fluidity while a wave results from the transmission of vibrations of water particles.

no net force acting on the body. It is incorrect to assume that a net force is needed to keep a body in uniform motion. To maintain a body in uniform motion, we need to apply an external force to counter the frictional force, so that the two forces sum up to zero net external force.

To summarise, if the net external force is zero, a body at rest continues to remain at rest and a body in motion continues to move with a uniform velocity. This property of the body is called inertia. Inertia means '**resistance to change**'. A body does not change its state of rest or uniform motion, unless an external force compels it to change that state.

4.4 NEWTON'S FIRST LAW OF MOTION

Galileo's simple, but revolutionary ideas dethroned Aristotelian mechanics. A new mechanics had to be developed. This task was

The state of rest or uniform linear motion both imply zero acceleration. The first law of motion can, therefore, be simply expressed as:

If the net external force on a body is zero, its acceleration is zero. Acceleration can be non zero only if there is a net external force on the body.

Two kinds of situations are encountered in the application of this law in practice. In some examples, we know that the net external force on the object is zero. In that case we can conclude that the acceleration of the object is zero. For example, a spaceship out in interstellar space, far from all other objects and with all its rockets turned off, has no net external force acting on it. Its acceleration, according to the first law, must be zero. If it is in motion, it must continue to move with a uniform velocity.

More often, however, we do not know all the forces to begin with. In that case, if we know that an object is unaccelerated (i.e. it is either at rest or in uniform linear motion), we can infer from the first law that the net external force on the object must be zero. Gravity is everywhere. For terrestrial phenomena, in particular, every object experiences gravitational force due to the earth. Also objects in motion generally experience friction, viscous drag, etc. If then, on earth, an object is at rest or in uniform linear motion, it is not because there are no forces acting on it, but because the various external forces cancel out i.e. add up to zero net external force.

Consider a book at rest on a horizontal surface Fig. (4.2(a)). It is subject to two external forces : the force due to gravity (i.e. its weight W) acting downward and the upward force on the book by the table, the normal force R . R is a self-adjusting force. This is an example of the kind of situation mentioned above. The forces are not quite known fully but the state of motion is known. We observe the book to be at rest. Therefore, we conclude from the first law that the magnitude of R equals that of W . A statement often encountered is : "Since $W = R$, forces cancel and, therefore, the book is at rest". This is incorrect reasoning. The correct statement is : "Since the book is observed to be at rest, the net external force on it must be zero, according to the first law. This implies that the normal force R must be equal and opposite to the weight W ".

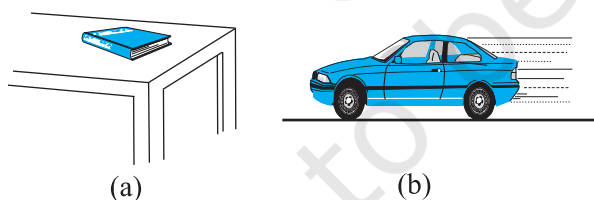

Fig. 4.2 (a) a book at rest on the table, and (b) a car moving with uniform velocity. The net force is zero in each case.

Consider the motion of a car starting from rest, picking up speed and then moving on a smooth straight road with uniform speed (Fig. (4.2(b))). When the car is stationary, there is no net force acting on it. During pick-up, it accelerates. This must happen due to a net external force. Note, it has to be an external force.

The acceleration of the car cannot be accounted for by any internal force. This might sound surprising, but it is true. The only conceivable external force along the road is the force of friction. It is the frictional force that accelerates the car as a whole. (You will learn about friction in section 4.9). When the car moves with constant velocity, there is no net external force.

The property of inertia contained in the First law is evident in many situations. Suppose we are standing in a stationary bus and the driver starts the bus suddenly. We get thrown backward with a jerk. Why? Our feet are in touch with the floor. If there were no friction, we would remain where we were, while the floor of the bus would simply slip forward under our feet and the back of the bus would hit us. However, fortunately, there is some friction between the feet and the floor. If the start is not too sudden, i.e. if the acceleration is moderate, the frictional force would be enough to accelerate our feet along with the bus. But our body is not strictly a rigid body. It is deformable, i.e. it allows some relative displacement between different parts. What this means is that while our feet go with the bus, the rest of the body remains where it is due to inertia. Relative to the bus, therefore, we are thrown backward. As soon as that happens, however, the muscular forces on the rest of the body (by the feet) come into play to move the body along with the bus. A similar thing happens when the bus suddenly stops. Our feet stop due to the friction which does not allow relative motion between the feet and the floor of the bus. But the rest of the body continues to move forward due to inertia. We are thrown forward. The restoring muscular forces again come into play and bring the body to rest.

► **Example 4.1** An astronaut accidentally gets separated out of his small spaceship accelerating in inter stellar space at a constant rate of 100 m s^{-2} . What is the acceleration of the astronaut the instant after he is outside the spaceship? (Assume that there are no nearby stars to exert gravitational force on him.)

Answer Since there are no nearby stars to exert gravitational force on him and the small spaceship exerts negligible gravitational attraction on him, the net force acting on the

astronaut, once he is out of the spaceship, is zero. By the first law of motion the acceleration of the astronaut is zero. ◀

4.5 NEWTON'S SECOND LAW OF MOTION

The first law refers to the simple case when the net external force on a body is zero. The second law of motion refers to the general situation when there is a net external force acting on the body. It relates the net external force to the acceleration of the body.

Momentum

Momentum of a body is defined to be the product of its mass m and velocity \mathbf{v} , and is denoted by \mathbf{p} :

$$\mathbf{p} = m \mathbf{v} \quad (4.1)$$

Momentum is clearly a vector quantity. The following common experiences indicate the importance of this quantity for considering the effect of force on motion.

- Suppose a light-weight vehicle (say a small car) and a heavy weight vehicle (say a loaded truck) are parked on a horizontal road. We all know that a much greater force is needed to push the truck than the car to bring them to the same speed in same time. Similarly, a greater opposing force is needed to stop a heavy body than a light body in the same time, if they are moving with the same speed.
- If two stones, one light and the other heavy, are dropped from the top of a building, a person on the ground will find it easier to catch the light stone than the heavy stone. The mass of a body is thus an important parameter that determines the effect of force on its motion.
- Speed is another important parameter to consider. A bullet fired by a gun can easily pierce human tissue before it stops, resulting in casualty. The same bullet fired with moderate speed will not cause much damage. Thus for a given mass, the greater the speed, the greater is the opposing force needed to stop the body in a certain time. Taken together, the product of mass and velocity, that is momentum, is evidently a relevant variable of motion. The greater the change in the momentum in a given time, the greater is the force that needs to be applied.
- A seasoned cricketer catches a cricket ball coming in with great speed far more easily than a novice, who can hurt his hands in the

act. One reason is that the cricketer allows a longer time for his hands to stop the ball. As you may have noticed, he draws in the hands backward in the act of catching the ball (Fig. 4.3). The novice, on the other hand, keeps his hands fixed and tries to catch the ball almost instantly. He needs to provide a much greater force to stop the ball instantly, and this hurts. The conclusion is clear: force not only depends on the change in momentum, but also on how fast the change is brought about. The same change in momentum brought about in a shorter time needs a greater applied force. In short, the greater the rate of change of momentum, the greater is the force.



Fig. 4.3 Force not only depends on the change in momentum but also on how fast the change is brought about. A seasoned cricketer draws in his hands during a catch, allowing greater time for the ball to stop and hence requires a smaller force.

- Observations confirm that the product of mass and velocity (i.e. momentum) is basic to the effect of force on motion. Suppose a fixed force is applied for a certain interval of time on two bodies of different masses, initially at rest, the lighter body picks up a greater speed than the heavier body. However, at the end of the time interval, observations show that each body acquires the same momentum. **Thus the same force for the same time causes the same change in momentum for different bodies.** This is a crucial clue to the second law of motion.
- In the preceding observations, the vector

character of momentum has not been evident. In the examples so far, momentum and change in momentum both have the same direction. But this is not always the case. Suppose a stone is rotated with uniform speed in a horizontal plane by means of a string, the magnitude of momentum is fixed, but its direction changes (Fig. 4.4). A force is needed to cause this change in momentum vector. This force is provided by our hand through the string. Experience suggests that our hand needs to exert a greater force if the stone is rotated at greater speed or in a circle of smaller radius, or both. This corresponds to greater acceleration or equivalently a greater rate of change in momentum vector. This suggests that the greater the rate of change in momentum vector the greater is the force applied.

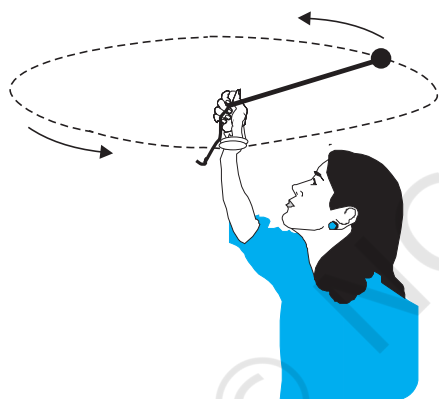

Fig. 4.4 Force is necessary for changing the direction of momentum, even if its magnitude is constant. We can feel this while rotating a stone in a horizontal circle with uniform speed by means of a string.

These qualitative observations lead to the **second law of motion** expressed by Newton as follows:

The rate of change of momentum of a body is directly proportional to the applied force and takes place in the direction in which the force acts.

Thus, if under the action of a force \mathbf{F} for time interval Δt , the velocity of a body of mass m changes from \mathbf{v} to $\mathbf{v} + \Delta\mathbf{v}$ i.e. its initial momentum $\mathbf{p} = m\mathbf{v}$ changes by $\Delta\mathbf{p} = m\Delta\mathbf{v}$. According to the Second Law,

$$\mathbf{F} \propto \frac{\Delta\mathbf{p}}{\Delta t} \quad \text{or} \quad \mathbf{F} = k \frac{\Delta\mathbf{p}}{\Delta t}$$

where k is a constant of proportionality. Taking the limit $\Delta t \rightarrow 0$, the term $\frac{\Delta\mathbf{p}}{\Delta t}$ becomes the derivative or differential co-efficient of \mathbf{p} with respect to t , denoted by $\frac{d\mathbf{p}}{dt}$. Thus

$$\mathbf{F} = k \frac{d\mathbf{p}}{dt} \quad (4.2)$$

For a body of fixed mass m ,

$$\frac{d\mathbf{p}}{dt} = \frac{d}{dt}(m\mathbf{v}) = m \frac{d\mathbf{v}}{dt} = m\mathbf{a} \quad (4.3)$$

i.e the Second Law can also be written as

$$\mathbf{F} = k m \mathbf{a} \quad (4.4)$$

which shows that force is proportional to the product of mass m and acceleration \mathbf{a} .

The unit of force has not been defined so far. In fact, we use Eq. (4.4) to define the unit of force. We, therefore, have the liberty to choose any constant value for k . For simplicity, we choose $k = 1$. The second law then is

$$\mathbf{F} = \frac{d\mathbf{p}}{dt} = m\mathbf{a} \quad (4.5)$$

In SI unit force is one that causes an acceleration of 1 m s^{-2} to a mass of 1 kg . This unit is known as **newton**: $1 \text{ N} = 1 \text{ kg m s}^{-2}$.

Let us note at this stage some important points about the second law:

1. In the second law, $\mathbf{F} = 0$ implies $\mathbf{a} = 0$. The second law is obviously consistent with the first law.
2. The second law of motion is a vector law. It is equivalent to three equations, one for each component of the vectors:

$$\begin{aligned} F_x &= \frac{dp_x}{dt} = ma_x \\ F_y &= \frac{dp_y}{dt} = ma_y \\ F_z &= \frac{dp_z}{dt} = ma_z \end{aligned} \quad (4.6)$$

This means that if a force is not parallel to the velocity of the body, but makes some angle with it, it changes only the component of velocity along the direction of force. The

component of velocity normal to the force remains unchanged. For example, in the motion of a projectile under the vertical gravitational force, the horizontal component of velocity remains unchanged (Fig. 4.5).

3. The second law of motion given by Eq. (4.5) is applicable to a single point particle. The force \mathbf{F} in the law stands for the net external force on the particle and \mathbf{a} stands for acceleration of the particle. It turns out, however, that the law in the same form applies to a rigid body or, even more generally, to a system of particles. In that case, \mathbf{F} refers to the total external force on the system and \mathbf{a} refers to the acceleration of the system as a whole. More precisely, \mathbf{a} is the acceleration of the centre of mass of the system about which we shall study in detail in Chapter 6. **Any internal forces in the system are not to be included in \mathbf{F} .**

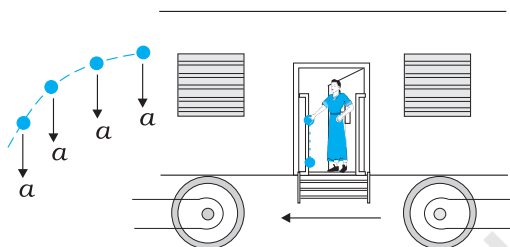

Fig. 4.5 Acceleration at an instant is determined by the force at that instant. The moment after a stone is dropped out of an accelerated train, it has no horizontal acceleration or force, if air resistance is neglected. The stone carries no memory of its acceleration with the train a moment ago.

4. The second law of motion is a local relation which means that force \mathbf{F} at a point in space (location of the particle) at a certain instant of time is related to \mathbf{a} at that point at that instant. Acceleration here and now is determined by the force here and now, **not by any history of the motion of the particle** (See Fig. 4.5).

► **Example 4.2** A bullet of mass 0.04 kg moving with a speed of 90 m s^{-1} enters a heavy wooden block and is stopped after a distance of 60 cm . What is the average resistive force exerted by the block on the bullet?

Answer The retardation 'a' of the bullet (assumed constant) is given by

$$a = \frac{-u^2}{2s} = \frac{-90 \times 90}{2 \times 0.6} \text{ m s}^{-2} = -6750 \text{ m s}^{-2}$$

The retarding force, by the second law of motion, is

$$= 0.04 \text{ kg} \times 6750 \text{ m s}^{-2} = 270 \text{ N}$$

The actual resistive force, and therefore, retardation of the bullet may not be uniform. The answer therefore, only indicates the average resistive force. ◀

► **Example 4.3** The motion of a particle of mass m is described by $y = ut + \frac{1}{2}gt^2$. Find the force acting on the particle.

Answer We know

$$y = ut + \frac{1}{2}gt^2$$

Now,

$$v = \frac{dy}{dt} = u + gt$$

$$\text{acceleration, } a = \frac{dv}{dt} = g$$

Then the force is given by Eq. (4.5)

$$F = ma = mg$$

Thus the given equation describes the motion of a particle under acceleration due to gravity and y is the position coordinate in the direction of g . ◀

Impulse

We sometimes encounter examples where a large force acts for a very short duration producing a finite change in momentum of the body. For example, when a ball hits a wall and bounces back, the force on the ball by the wall acts for a very short time when the two are in contact, yet the force is large enough to reverse the momentum of the ball. Often, in these situations, the force and the time duration are difficult to ascertain separately. However, the product of force and time, which is the change in momentum of the body remains a measurable quantity. This product is called impulse:

$$\begin{aligned} \text{Impulse} &= \text{Force} \times \text{time duration} \\ &= \text{Change in momentum} \end{aligned} \quad (4.7)$$

A large force acting for a short time to produce a finite change in momentum is called an *impulsive force*. In the history of science, impulsive forces were put in a conceptually different category from ordinary forces. Newtonian mechanics has no such distinction. Impulsive force is like any other force – except that it is large and acts for a short time.

▶ **Example 4.4** A batsman hits back a ball straight in the direction of the bowler without changing its initial speed of 12 m s^{-1} . If the mass of the ball is 0.15 kg , determine the impulse imparted to the ball. (Assume linear motion of the ball)

Answer Change in momentum
 $= 0.15 \times 12 - (-0.15 \times 12)$
 $= 3.6 \text{ N s}$,

Impulse = 3.6 N s ,
 in the direction from the batsman to the bowler.

This is an example where the force on the ball by the batsman and the time of contact of the ball and the bat are difficult to know, but the impulse is readily calculated. ◀

4.6 NEWTON'S THIRD LAW OF MOTION

The second law relates the external force on a body to its acceleration. What is the origin of the external force on the body? What agency provides the external force? The simple answer in Newtonian mechanics is that the external force on a body always arises due to some other body. Consider a pair of bodies *A* and *B*. *B* gives rise to an external force on *A*. A natural question is: Does *A* in turn give rise to an external force on *B*? In some examples, the answer seems clear. If you press a coiled spring, the spring is compressed by the force of your hand. The compressed spring in turn exerts a force on your hand and you can feel it. But what if the bodies are not in contact? The earth pulls a stone downwards due to gravity. Does the stone exert a force on the earth? The answer is not obvious since we hardly see the effect of the stone on the earth. The answer according to Newton is: Yes, the stone does exert an equal and opposite force on the earth. We do not notice it since the earth is very massive and the effect of a small force on its motion is negligible.

Thus, according to Newtonian mechanics, force never occurs singly in nature. Force is the mutual interaction between two bodies. Forces always occur in pairs. Further, the mutual forces between two bodies are always equal and opposite. This idea was expressed by Newton in the form of the **third law of motion**.

To every action, there is always an equal and opposite reaction.

Newton's wording of the third law is so crisp and beautiful that it has become a part of common language. For the same reason perhaps, misconceptions about the third law abound. Let us note some important points about the third law, particularly in regard to the usage of the terms : action and reaction.

1. The terms action and reaction in the third law mean nothing else but 'force'. Using different terms for the same physical concept can sometimes be confusing. A simple and clear way of stating the third law is as follows :

Forces always occur in pairs. Force on a body A by B is equal and opposite to the force on the body B by A.

2. The terms action and reaction in the third law may give a wrong impression that action comes before reaction i.e action is the cause and reaction the effect. **There is no cause-effect relation implied in the third law. The force on A by B and the force on B by A act at the same instant.** By the same reasoning, any one of them may be called action and the other reaction.
3. Action and reaction forces act on different bodies, not on the same body. Consider a pair of bodies *A* and *B*. According to the third law,

$$\mathbf{F}_{AB} = -\mathbf{F}_{BA} \quad (4.8)$$

(force on A by B) = – (force on B by A)

Thus if we are considering the motion of any one body (*A* or *B*), only one of the two forces is relevant. It is an error to add up the two forces and claim that the net force is zero.

However, if you are considering the system of two bodies as a whole, \mathbf{F}_{AB} and \mathbf{F}_{BA} are internal forces of the system (*A* + *B*). They add up to give a null force. Internal forces in a body or a system of particles thus cancel away

in pairs. This is an important fact that enables the second law to be applicable to a body or a system of particles (See Chapter 6).

Example 4.5 Two identical billiard balls strike a rigid wall with the same speed but at different angles, and get reflected without any change in speed, as shown in Fig. 4.6. What is (i) the direction of the force on the wall due to each ball? (ii) the ratio of the magnitudes of impulses imparted to the balls by the wall?

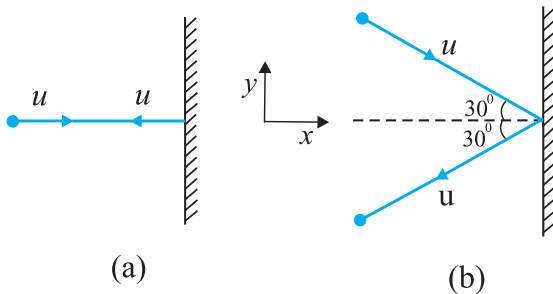

Fig. 4.6

Answer An instinctive answer to (i) might be that the force on the wall in case (a) is normal to the wall, while that in case (b) is inclined at 30° to the normal. This answer is wrong. The force on the wall is normal to the wall in both cases.

How to find the force on the wall? The trick is to consider the force (or impulse) on the ball due to the wall using the second law, and then use the third law to answer (i). Let u be the speed of each ball before and after collision with the wall, and m the mass of each ball. Choose the x and y axes as shown in the figure, and consider the change in momentum of the ball in each case :

Case (a)

$$\begin{aligned} (p_x)_{\text{initial}} &= mu & (p_y)_{\text{initial}} &= 0 \\ (p_x)_{\text{final}} &= -mu & (p_y)_{\text{final}} &= 0 \end{aligned}$$

Impulse is the change in momentum vector. Therefore,

$$\begin{aligned} \text{x-component of impulse} &= -2mu \\ \text{y-component of impulse} &= 0 \end{aligned}$$

Impulse and force are in the same direction. Clearly, from above, the force on the ball due to the wall is normal to the wall, along the negative x -direction. Using Newton's third law of motion,

the force on the wall due to the ball is normal to the wall along the positive x -direction. The magnitude of force cannot be ascertained since the small time taken for the collision has not been specified in the problem.

Case (b)

$$(p_x)_{\text{initial}} = mu \cos 30^\circ, (p_y)_{\text{initial}} = -mu \sin 30^\circ$$

$$(p_x)_{\text{final}} = -mu \cos 30^\circ, (p_y)_{\text{final}} = -mu \sin 30^\circ$$

Note, while p_x changes sign after collision, p_y does not. Therefore,

$$\begin{aligned} \text{x-component of impulse} &= -2mu \cos 30^\circ \\ \text{y-component of impulse} &= 0 \end{aligned}$$

The direction of impulse (and force) is the same as in (a) and is normal to the wall along the negative x direction. As before, using Newton's third law, the force on the wall due to the ball is normal to the wall along the positive x direction.

The ratio of the magnitudes of the impulses imparted to the balls in (a) and (b) is

$$2mu / (2mu \cos 30^\circ) = \frac{2}{\sqrt{3}} \approx 1.2$$

4.7 CONSERVATION OF MOMENTUM

The second and third laws of motion lead to an important consequence: the law of conservation of momentum. Take a familiar example. A bullet is fired from a gun. If the force on the bullet by the gun is \mathbf{F} , the force on the gun by the bullet is $-\mathbf{F}$, according to the third law. The two forces act for a common interval of time Δt . According to the second law, $\mathbf{F} \Delta t$ is the change in momentum of the bullet and $-\mathbf{F} \Delta t$ is the change in momentum of the gun. Since initially, both are at rest, the change in momentum equals the final momentum for each. Thus if \mathbf{p}_b is the momentum of the bullet after firing and \mathbf{p}_g is the recoil momentum of the gun, $\mathbf{p}_g = -\mathbf{p}_b$ i.e. $\mathbf{p}_b + \mathbf{p}_g = 0$. That is, the total momentum of the (bullet + gun) system is conserved.

Thus in an isolated system (i.e. a system with no external force), mutual forces between pairs of particles in the system can cause momentum change in individual particles, but since the mutual forces for each pair are equal and opposite, the momentum changes cancel in pairs and the total momentum remains unchanged. This fact is known as the **law of conservation of momentum** :

The total momentum of an isolated system of interacting particles is conserved.

An important example of the application of the law of conservation of momentum is the collision of two bodies. Consider two bodies A and B, with initial momenta \mathbf{p}_A and \mathbf{p}_B . The bodies collide, get apart, with final momenta \mathbf{p}'_A and \mathbf{p}'_B respectively. By the Second Law

$$\mathbf{F}_{AB}\Delta t = \mathbf{p}'_A - \mathbf{p}_A \quad \text{and}$$

$$\mathbf{F}_{BA}\Delta t = \mathbf{p}'_B - \mathbf{p}_B$$

(where we have taken a common interval of time for both forces i.e. the time for which the two bodies are in contact.)

Since $\mathbf{F}_{AB} = -\mathbf{F}_{BA}$ by the third law,

$$\mathbf{p}'_A - \mathbf{p}_A = -(\mathbf{p}'_B - \mathbf{p}_B)$$

$$\text{i.e.} \quad \mathbf{p}'_A + \mathbf{p}'_B = \mathbf{p}_A + \mathbf{p}_B \quad (4.9)$$

which shows that the total final momentum of the isolated system equals its initial momentum. Notice that this is true whether the collision is elastic or inelastic. In elastic collisions, there is a second condition that the total initial kinetic energy of the system equals the total final kinetic energy (See Chapter 5).

4.8 EQUILIBRIUM OF A PARTICLE

Equilibrium of a particle in mechanics refers to the situation when the net external force on the particle is zero.* According to the first law, this means that, the particle is either at rest or in uniform motion.

If two forces \mathbf{F}_1 and \mathbf{F}_2 , act on a particle, equilibrium requires

$$\mathbf{F}_1 = -\mathbf{F}_2 \quad (4.10)$$

i.e. the two forces on the particle must be equal and opposite. Equilibrium under three concurrent forces \mathbf{F}_1 , \mathbf{F}_2 and \mathbf{F}_3 requires that the vector sum of the three forces is zero.

$$\mathbf{F}_1 + \mathbf{F}_2 + \mathbf{F}_3 = 0 \quad (4.11)$$

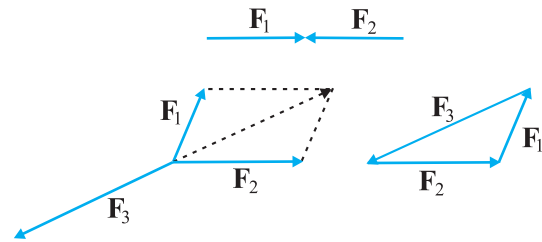

Fig. 4.7 Equilibrium under concurrent forces.

In other words, the resultant of any two forces say \mathbf{F}_1 and \mathbf{F}_2 , obtained by the parallelogram law of forces must be equal and opposite to the third force, \mathbf{F}_3 . As seen in Fig. 4.7, the three forces in equilibrium can be represented by the sides of a triangle with the vector arrows taken in the same sense. The result can be generalised to any number of forces. A particle is in equilibrium under the action of forces $\mathbf{F}_1, \mathbf{F}_2, \dots, \mathbf{F}_n$ if they can be represented by the sides of a closed n-sided polygon with arrows directed in the same sense.

Equation (4.11) implies that

$$F_{1x} + F_{2x} + F_{3x} = 0$$

$$F_{1y} + F_{2y} + F_{3y} = 0$$

$$F_{1z} + F_{2z} + F_{3z} = 0$$

$$(4.12)$$

where F_{1x}, F_{1y} and F_{1z} are the components of \mathbf{F}_1 along x, y and z directions respectively.

Example 4.6 See Fig. 4.8. A mass of 6 kg is suspended by a rope of length 2 m from the ceiling. A force of 50 N in the horizontal direction is applied at the mid-point P of the rope, as shown. What is the angle the rope makes with the vertical in equilibrium? (Take $g = 10 \text{ m s}^{-2}$). Neglect the mass of the rope.

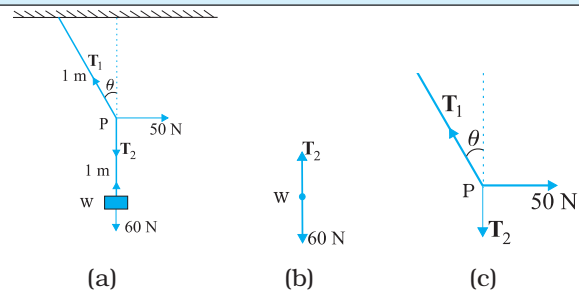

Fig. 4.8

* Equilibrium of a body requires not only translational equilibrium (zero net external force) but also rotational equilibrium (zero net external torque), as we shall see in Chapter 6.

Answer Figures 4.8(b) and 4.8(c) are known as free-body diagrams. Figure 4.8(b) is the free-body diagram of W and Fig. 4.8(c) is the free-body diagram of point P .

Consider the equilibrium of the weight W . Clearly, $T_2 = 6 \times 10 = 60$ N.

Consider the equilibrium of the point P under the action of three forces - the tensions T_1 and T_2 , and the horizontal force 50 N. The horizontal and vertical components of the resultant force must vanish separately :

$$T_1 \cos \theta = T_2 = 60 \text{ N}$$

$$T_1 \sin \theta = 50 \text{ N}$$

which gives that

$$\tan \theta = \frac{5}{6} \text{ or } \theta = \tan^{-1} \left(\frac{5}{6} \right) = 40^\circ$$

Note the answer does not depend on the length of the rope (assumed massless) nor on the point at which the horizontal force is applied. ◀

4.9 COMMON FORCES IN MECHANICS

In mechanics, we encounter several kinds of forces. The gravitational force is, of course, pervasive. Every object on the earth experiences the force of gravity due to the earth. Gravity also governs the motion of celestial bodies. The gravitational force can act at a distance without the need of any intervening medium.

All the other forces common in mechanics are contact forces.* As the name suggests, a contact force on an object arises due to contact with some other object: solid or fluid. When bodies are in contact (e.g. a book resting on a table, a system of rigid bodies connected by rods, hinges and

other types of supports), there are mutual contact forces (for each pair of bodies) satisfying the third law. The component of contact force normal to the surfaces in contact is called normal reaction. The component parallel to the surfaces in contact is called friction. Contact forces arise also when solids are in contact with fluids. For example, for a solid immersed in a fluid, there is an upward buoyant force equal to the weight of the fluid displaced. The viscous force, air resistance, etc are also examples of contact forces (Fig. 4.9).

Two other common forces are tension in a string and the force due to spring. When a spring is compressed or extended by an external force, a restoring force is generated. This force is usually proportional to the compression or elongation (for small displacements). The spring force F is written as $F = -kx$ where x is the displacement and k is the force constant. The negative sign denotes that the force is opposite to the displacement from the unstretched state. For an inextensible string, the force constant is very high. The restoring force in a string is called tension. It is customary to use a constant tension T throughout the string. This assumption is true for a string of negligible mass.

We learnt that there are four fundamental forces in nature. Of these, the weak and strong forces appear in domains that do not concern us here. Only the gravitational and electrical forces are relevant in the context of mechanics. The different contact forces of mechanics mentioned above fundamentally arise from electrical forces. This may seem surprising

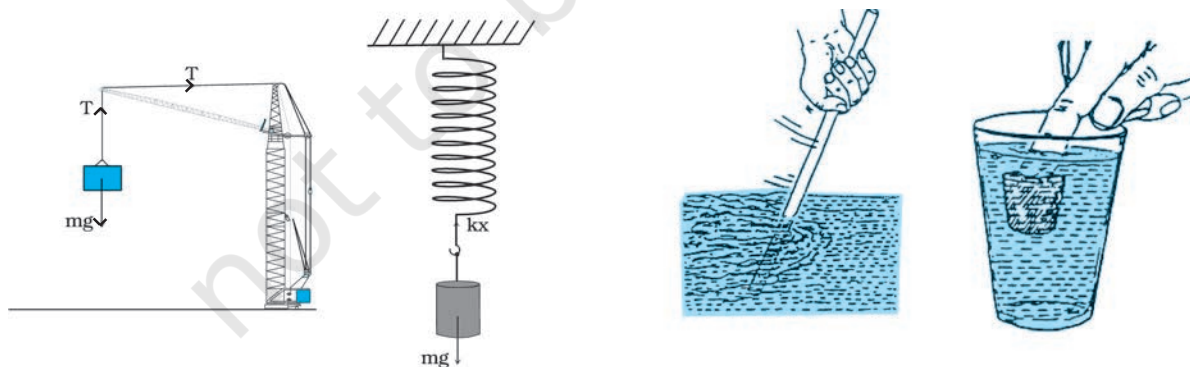

Fig. 4.9 Some examples of contact forces in mechanics.

* We are not considering, for simplicity, charged and magnetic bodies. For these, besides gravity, there are electrical and magnetic non-contact forces.

since we are talking of uncharged and non-magnetic bodies in mechanics. At the microscopic level, all bodies are made of charged constituents (nuclei and electrons) and the various contact forces arising due to elasticity of bodies, molecular collisions and impacts, etc. can ultimately be traced to the electrical forces between the charged constituents of different bodies. The detailed microscopic origin of these forces is, however, complex and not useful for handling problems in mechanics at the macroscopic scale. This is why they are treated as different types of forces with their characteristic properties determined empirically.

4.9.1 Friction

Let us return to the example of a body of mass m at rest on a horizontal table. The force of gravity (mg) is cancelled by the normal reaction force (N) of the table. Now suppose a force F is applied horizontally to the body. We know from experience that a small applied force may not be enough to move the body. But if the applied force F were the only external force on the body, it must move with acceleration F/m , however small. Clearly, the body remains at rest because some other force comes into play in the horizontal direction and opposes the applied force F , resulting in zero net force on the body. This force f_s parallel to the surface of the body in contact with the table is known as frictional force, or simply friction (Fig. 4.10(a)). The subscript stands for static friction to distinguish it from kinetic friction f_k that we consider later (Fig. 4.10(b)). Note that static friction does not

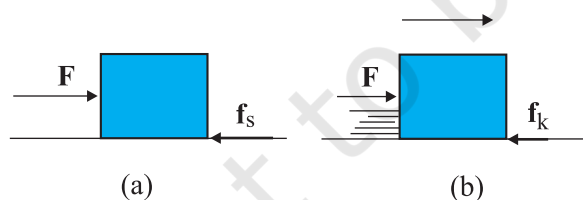

Fig. 4.10 Static and sliding friction: (a) Impending motion of the body is opposed by static friction. When external force exceeds the maximum limit of static friction, the body begins to move. (b) Once the body is in motion, it is subject to sliding or kinetic friction which opposes relative motion between the two surfaces in contact. Kinetic friction is usually less than the maximum value of static friction.

exist by itself. When there is no applied force, there is no static friction. It comes into play the moment there is an applied force. As the applied force F increases, f_s also increases, remaining equal and opposite to the applied force (up to a certain limit), keeping the body at rest. Hence, it is called **static friction**. Static friction opposes **impending motion**. The term impending motion means motion that would take place (but does not actually take place) under the applied force, if friction were absent.

We know from experience that as the applied force exceeds a certain limit, the body begins to move. It is found experimentally that the limiting

value of static friction $(f_s)_{\max}$ is independent of the area of contact and varies with the normal force (N) approximately as :

$$(f_s)_{\max} = \mu_s N \quad (4.13)$$

where μ_s is a constant of proportionality depending only on the nature of the surfaces in contact. The constant μ_s is called the coefficient of static friction. The law of static friction may thus be written as

$$f_s \leq \mu_s N \quad (4.14)$$

If the applied force F exceeds $(f_s)_{\max}$ the body begins to slide on the surface. It is found experimentally that when relative motion has started, the frictional force decreases from the static maximum value $(f_s)_{\max}$. Frictional force that opposes relative motion between surfaces in contact is called kinetic or sliding friction and is denoted by f_k . Kinetic friction, like static friction, is found to be independent of the area of contact. Further, it is nearly independent of the velocity. It satisfies a law similar to that for static friction:

$$f_k = \mu_k N \quad (4.15)$$

where μ_k the coefficient of kinetic friction, depends only on the surfaces in contact. As mentioned above, experiments show that μ_k is less than μ_s . When relative motion has begun, the acceleration of the body according to the second law is $(F - f_k)/m$. For a body moving with constant velocity, $F = f_k$. If the applied force on the body is removed, its acceleration is $-f_k/m$ and it eventually comes to a stop.

The laws of friction given above do not have the status of fundamental laws like those for gravitational, electric and magnetic forces. They are empirical relations that are only

approximately true. Yet they are very useful in practical calculations in mechanics.

Thus, when two bodies are in contact, each experiences a contact force by the other. Friction, by definition, is the component of the contact force parallel to the surfaces in contact, which opposes impending or actual relative motion between the two surfaces. Note that it is not motion, but **relative motion** that the frictional force opposes. Consider a box lying in the compartment of a train that is accelerating. If the box is stationary relative to the train, it is in fact accelerating along with the train. What forces cause the acceleration of the box? Clearly, the only conceivable force in the horizontal direction is the force of friction. If there were no friction, the floor of the train would slip by and the box would remain at its initial position due to inertia (and hit the back side of the train). This impending relative motion is opposed by the static friction f_s . Static friction provides the same acceleration to the box as that of the train, keeping it stationary relative to the train.

► **Example 4.7** Determine the maximum acceleration of the train in which a box lying on its floor will remain stationary, given that the co-efficient of static friction between the box and the train's floor is 0.15.

Answer Since the acceleration of the box is due to the static friction,

$$\begin{aligned}
 ma &= f_s \leq \mu_s N = \mu_s mg \\
 \text{i.e. } a &\leq \mu_s g \\
 \therefore a_{\max} &= \mu_s g = 0.15 \times 10 \text{ m s}^{-2} \\
 &= 1.5 \text{ m s}^{-2}
 \end{aligned}$$

► **Example 4.8** See Fig. 4.11. A mass of 4 kg rests on a horizontal plane. The plane is gradually inclined until at an angle $\theta = 15^\circ$ with the horizontal, the mass just begins to slide. What is the coefficient of static friction between the block and the surface?

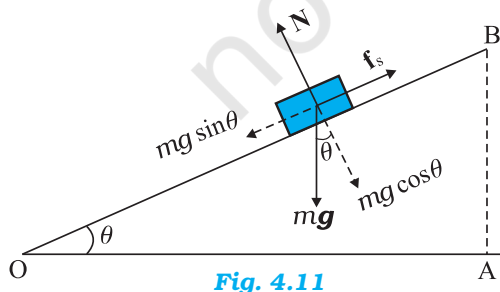

Fig. 4.11

Answer The forces acting on a block of mass m at rest on an inclined plane are (i) the weight mg acting vertically downwards (ii) the normal force N of the plane on the block, and (iii) the static frictional force f_s opposing the impending motion. In equilibrium, the resultant of these forces must be zero. Resolving the weight mg along the two directions shown, we have

$$mg \sin \theta = f_s, \quad mg \cos \theta = N$$

As θ increases, the self-adjusting frictional force f_s increases until at $\theta = \theta_{\max}$, f_s achieves its maximum value, $(f_s)_{\max} = \mu_s N$.

Therefore,

$$\tan \theta_{\max} = \mu_s \text{ or } \theta_{\max} = \tan^{-1} \mu_s$$

When θ becomes just a little more than θ_{\max} , there is a small net force on the block and it begins to slide. Note that θ_{\max} depends only on μ_s and is independent of the mass of the block.

For $\theta_{\max} = 15^\circ$,
 $\mu_s = \tan 15^\circ$
 $= 0.27$

► **Example 4.9** What is the acceleration of the block and trolley system shown in a Fig. 4.12(a), if the coefficient of kinetic friction between the trolley and the surface is 0.04? What is the tension in the string? (Take $g = 10 \text{ m s}^{-2}$). Neglect the mass of the string.

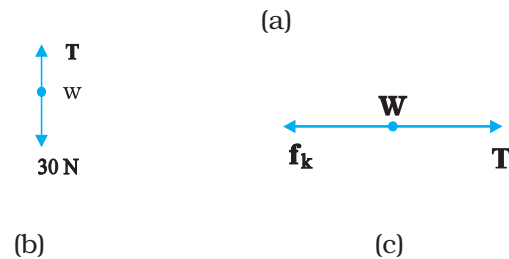
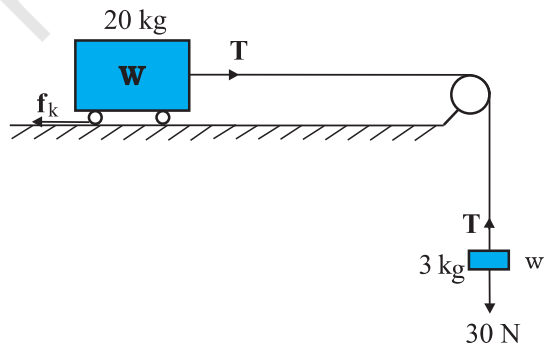

Fig. 4.12

Answer As the string is inextensible, and the pulley is smooth, the 3 kg block and the 20 kg trolley both have same magnitude of acceleration. Applying second law to motion of the block (Fig. 4.12(b)),

$$30 - T = 3a$$

Apply the second law to motion of the trolley (Fig. 4.12(c)),

$$\begin{aligned} T - f_k &= 20a \\ \text{Now } f_k &= \mu_k N, \\ \text{Here } \mu_k &= 0.04, \\ N &= 20 \times 10 \\ &= 200 \text{ N.} \end{aligned}$$

Thus the equation for the motion of the trolley is
 $T - 0.04 \times 200 = 20a$ Or $T - 8 = 20a$.

These equations give $a = \frac{22}{23} \text{ m s}^{-2} = 0.96 \text{ m s}^{-2}$
 and $T = 27.1 \text{ N}$. ◀

Rolling friction

A body like a ring or a sphere rolling without slipping over a horizontal plane will suffer no friction, in principle. At every instant, there is just one point of contact between the body and the plane and this point has no motion relative to the plane. In this ideal situation, kinetic or static friction is zero and the body should continue to roll with constant velocity. We know, in practice, this will not happen and some resistance to motion (rolling friction) does occur, i.e. to keep the body rolling, some applied force is needed. For the same weight, rolling friction is much smaller (even by 2 or 3 orders of magnitude) than static or sliding friction. This

is the reason why discovery of the wheel has been a major milestone in human history.

Rolling friction again has a complex origin, though somewhat different from that of static and sliding friction. During rolling, the surfaces in contact get momentarily deformed a little, and this results in a finite area (not a point) of the body being in contact with the surface. The net effect is that the component of the contact force parallel to the surface opposes motion.

We often regard friction as something undesirable. In many situations, like in a machine with different moving parts, friction does have a negative role. It opposes relative motion and thereby dissipates power in the form of heat, etc. Lubricants are a way of reducing kinetic friction in a machine. Another way is to use ball bearings between two moving parts of a machine [Fig. 4.13(a)]. Since the rolling friction between ball bearings and the surfaces in contact is very small, power dissipation is reduced. A thin cushion of air maintained between solid surfaces in relative motion is another effective way of reducing friction (Fig. 4.13(a)).

In many practical situations, however, friction is critically needed. Kinetic friction that dissipates power is nevertheless important for quickly stopping relative motion. It is made use of by brakes in machines and automobiles. Similarly, static friction is important in daily life. We are able to walk because of friction. It is impossible for a car to move on a very slippery road. On an ordinary road, the friction between the tyres and the road provides the necessary external force to accelerate the car.

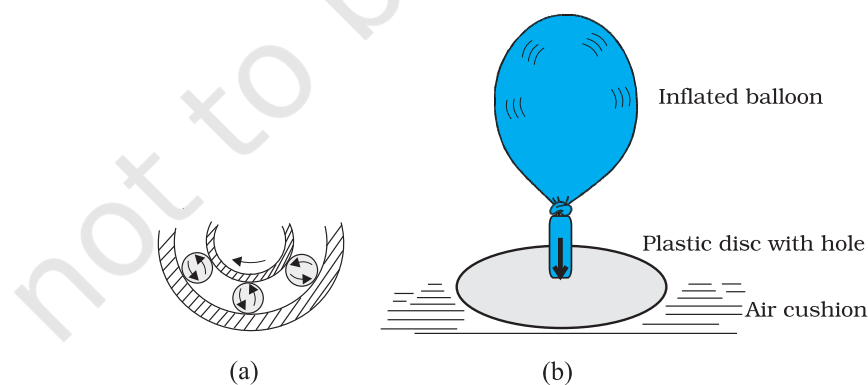

Fig. 4.13 Some ways of reducing friction. (a) Ball bearings placed between moving parts of a machine. (b) Compressed cushion of air between surfaces in relative motion.

4.10 CIRCULAR MOTION

We have seen in Chapter 4 that acceleration of a body moving in a circle of radius R with uniform speed v is v^2/R directed towards the centre. According to the second law, the force f_c providing this acceleration is :

$$f_c = \frac{mv^2}{R} \quad (4.16)$$

where m is the mass of the body. This force directed towards the centre is called the centripetal force. For a stone rotated in a circle by a string, the centripetal force is provided by the tension in the string. The centripetal force for motion of a planet around the sun is the

is the static friction that provides the centripetal acceleration. Static friction opposes the impending motion of the car moving away from the circle. Using equation (4.14) & (4.16) we get the result

$$f = \frac{mv^2}{R} \leq \mu_s N$$

$$v^2 \leq \frac{\mu_s RN}{m} = \mu_s Rg \quad [\because N = mg]$$

which is independent of the mass of the car. This shows that for a given value of μ_s and R , there is a maximum speed of circular motion of the car possible, namely

$$v_{\max} = \sqrt{\mu_s Rg} \quad (4.18)$$

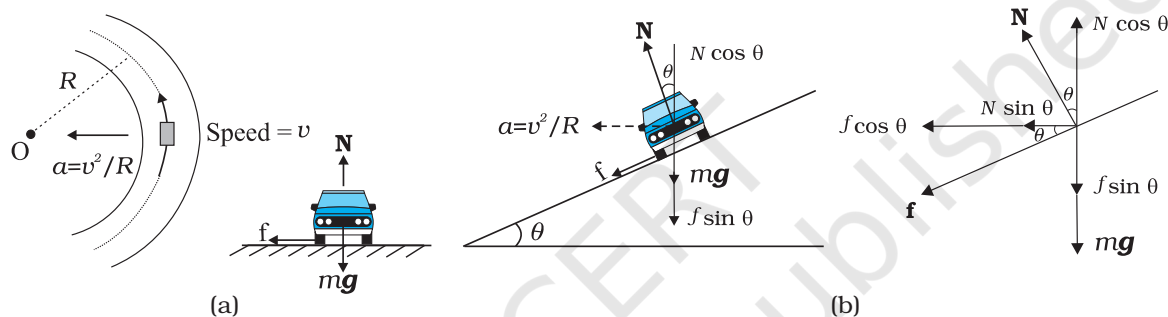

Fig. 4.14 Circular motion of a car on (a) a level road, (b) a banked road.

gravitational force on the planet due to the sun. For a car taking a circular turn on a horizontal road, the centripetal force is the force of friction.

The circular motion of a car on a flat and banked road give interesting application of the laws of motion.

Motion of a car on a level road

Three forces act on the car (Fig. 4.14(a)):

- (i) The weight of the car, mg
- (ii) Normal reaction, N
- (iii) Frictional force, f

As there is no acceleration in the vertical direction

$$N - mg = 0$$

$$N = mg \quad (4.17)$$

The centripetal force required for circular motion is along the surface of the road, and is provided by the component of the contact force between road and the car tyres along the surface. This by definition is the frictional force. Note that it

Motion of a car on a banked road

We can reduce the contribution of friction to the circular motion of the car if the road is banked (Fig. 4.14(b)). Since there is no acceleration along the vertical direction, the net force along this direction must be zero. Hence,

$$N \cos \theta = mg + f \sin \theta \quad (4.19a)$$

The centripetal force is provided by the horizontal components of N and f .

$$N \sin \theta + f \cos \theta = \frac{mv^2}{R} \quad (4.19b)$$

But $f \leq \mu_s N$

Thus to obtain v_{\max} we put

$$f = \mu_s N$$

Then Eqs. (4.19a) and (4.19b) become

$$N \cos \theta = mg + \mu_s N \sin \theta \quad (4.20a)$$

$$N \sin \theta + \mu_s N \cos \theta = mv^2/R \quad (4.20b)$$

From Eq. (4.20a), we obtain

$$N = \frac{mg}{\cos \theta - \mu_s \sin \theta}$$

Substituting value of N in Eq. (4.20b), we get

$$\frac{mg(\sin \theta + \mu_s \cos \theta)}{\cos \theta - \mu_s \sin \theta} = \frac{mv_{\max}^2}{R}$$

$$\text{or } v_{\max} = \left(Rg \frac{\mu_s + \tan \theta}{1 - \mu_s \tan \theta} \right)^{1/2} \quad (4.21)$$

Comparing this with Eq. (4.18) we see that maximum possible speed of a car on a banked road is greater than that on a flat road.

$$\text{For } \mu_s = 0 \text{ in Eq. (4.21),} \quad (4.22)$$

$$v_o = (Rg \tan \theta)^{1/2}$$

At this speed, frictional force is not needed at all to provide the necessary centripetal force. Driving at this speed on a banked road will cause little wear and tear of the tyres. The same equation also tells you that for $v < v_o$, frictional force will be up the slope and that a car can be parked only if $\tan \theta \leq \mu_s$.

▶ **Example 4.10** A cyclist speeding at 18 km/h on a level road takes a sharp circular turn of radius 3 m without reducing the speed. The co-efficient of static friction between the tyres and the road is 0.1. Will the cyclist slip while taking the turn?

Answer On an unbanked road, frictional force alone can provide the centripetal force needed to keep the cyclist moving on a circular turn without slipping. If the speed is too large, or if the turn is too sharp (i.e. of too small a radius) or both, the frictional force is not sufficient to provide the necessary centripetal force, and the cyclist slips. The condition for the cyclist not to slip is given by Eq. (4.18) :

$$v^2 \leq \mu_s Rg$$

Now, $R = 3 \text{ m}$, $g = 9.8 \text{ m s}^{-2}$, $\mu_s = 0.1$. That is, $\mu_s Rg = 2.94 \text{ m}^2 \text{ s}^{-2}$. $v = 18 \text{ km/h} = 5 \text{ m s}^{-1}$; i.e., $v^2 = 25 \text{ m}^2 \text{ s}^{-2}$. The condition is not obeyed. The cyclist will slip while taking the circular turn. ◀

▶ **Example 4.11** A circular racetrack of radius 300 m is banked at an angle of 15° . If the coefficient of friction between the wheels of a race-car and the road is 0.2, what is the (a) optimum speed of the race-car to avoid wear and tear on its tyres, and (b) maximum permissible speed to avoid slipping?

Answer On a banked road, the horizontal component of the normal force and the frictional force contribute to provide centripetal force to keep the car moving on a circular turn without slipping. At the optimum speed, the normal reaction's component is enough to provide the needed centripetal force, and the frictional force is not needed. The optimum speed v_o is given by Eq. (4.22):

$$v_o = (Rg \tan \theta)^{1/2}$$

Here $R = 300 \text{ m}$, $\theta = 15^\circ$, $g = 9.8 \text{ m s}^{-2}$; we have

$$v_o = 28.1 \text{ m s}^{-1}.$$

The maximum permissible speed v_{\max} is given by Eq. (4.21):

$$v_{\max} = \left(Rg \frac{\mu_s + \tan \theta}{1 - \mu_s \tan \theta} \right)^{1/2} = 38.1 \text{ m s}^{-1} \quad \blacktriangleleft$$

4.11 SOLVING PROBLEMS IN MECHANICS

The three laws of motion that you have learnt in this chapter are the foundation of mechanics. You should now be able to handle a large variety of problems in mechanics. A typical problem in mechanics usually does not merely involve a single body under the action of given forces. More often, we will need to consider an assembly of different bodies exerting forces on each other. Besides, each body in the assembly experiences the force of gravity. When trying to solve a problem of this type, it is useful to remember the fact that we can choose any part of the assembly and apply the laws of motion to that part provided we include all forces on the chosen part due to the remaining parts of the assembly. We may call the chosen part of the assembly as the system and the remaining part of the assembly (plus any other agencies of forces) as the environment. We have followed the same

method in solved examples. To handle a typical problem in mechanics systematically, one should use the following steps :

- (i) Draw a diagram showing schematically the various parts of the assembly of bodies, the links, supports, etc.
- (ii) Choose a convenient part of the assembly as one system.
- (iii) Draw a separate diagram which shows this system and all the forces on the system by the remaining part of the assembly. Include also the forces on the system by other agencies. **Do not include the forces on the environment by the system.** A diagram of this type is known as 'a free-body diagram'. (Note this does not imply that the system under consideration is without a net force).
- (iv) In a free-body diagram, include information about forces (their magnitudes and directions) that are either given or you are sure of (e.g., the direction of tension in a string along its length). The rest should be treated as unknowns to be determined using laws of motion.
- (v) If necessary, follow the same procedure for another choice of the system. In doing so, employ Newton's third law. That is, if in the free-body diagram of *A*, the force on *A* due to *B* is shown as *F*, then in the free-body diagram of *B*, the force on *B* due to *A* should be shown as $-F$.

The following example illustrates the above procedure :

▶ **Example 4.12** See Fig. 4.15. A wooden block of mass 2 kg rests on a soft horizontal floor. When an iron cylinder of mass 25 kg is placed on top of the block, the floor yields steadily and the block and the cylinder together go down with an acceleration of 0.1 m s^{-2} . What is the action of the block on the floor (a) before and (b) after the floor yields ? Take $g = 10 \text{ m s}^{-2}$. Identify the action-reaction pairs in the problem.

Answer

- (a) The block is at rest on the floor. Its free-body diagram shows two forces on the block, the force of gravitational attraction by the earth equal to $2 \times 10 = 20 \text{ N}$; and the normal force *R* of the floor on the block. By the First Law,

the net force on the block must be zero i.e., $R = 20 \text{ N}$. Using third law the action of the block (i.e. the force exerted on the floor by the block) is equal to 20 N and directed vertically downwards.

- (b) The system (block + cylinder) accelerates downwards with 0.1 m s^{-2} . The free-body diagram of the system shows two forces on the system : the force of gravity due to the earth (270 N); and the normal force *R'* by the floor. Note, the free-body diagram of the system does not show the internal forces between the block and the cylinder. Applying the second law to the system,

$$270 - R' = 27 \times 0.1 \text{ N}$$

$$\text{ie. } R' = 267.3 \text{ N}$$

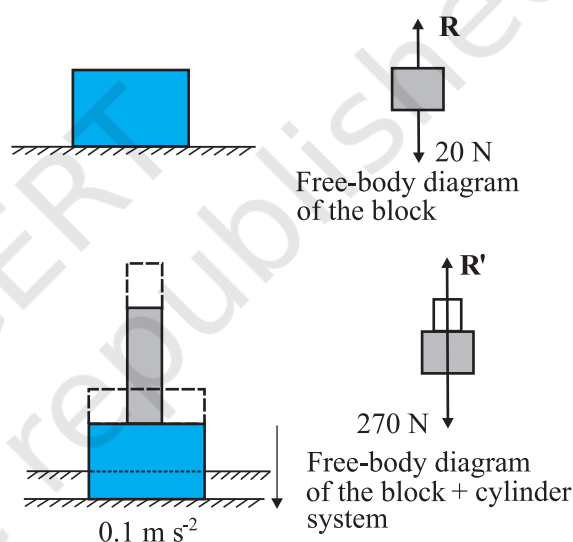

Fig. 4.15

By the third law, the action of the system on the floor is equal to 267.3 N vertically downward.

Action-reaction pairs

- For (a): (i) the force of gravity (20 N) on the block by the earth (say, action); the force of gravity on the earth by the block (reaction) equal to 20 N directed upwards (not shown in the figure).
 (ii) the force on the floor by the block (action); the force on the block by the floor (reaction).
- For (b): (i) the force of gravity (270 N) on the system by the earth (say, action); the force of gravity on the earth by the system (reaction), equal to 270 N,

directed upwards (not shown in the figure).

(ii) the force on the floor by the system (action); the force on the system by the floor (reaction). In addition, for (b), the force on the block by the cylinder and the force on the cylinder by the block also constitute an action-reaction pair.

The important thing to remember is that an action-reaction pair consists of mutual forces which are always equal and opposite between two bodies. Two forces on the same body which happen to be equal and opposite can never constitute an action-reaction pair. The force of

gravity on the mass in (a) or (b) and the normal force on the mass by the floor are not action-reaction pairs. These forces happen to be equal and opposite for (a) since the mass is at rest. They are not so for case (b), as seen already. The weight of the system is 270 N, while the normal force R' is 267.3 N. ◀

The practice of drawing free-body diagrams is of great help in solving problems in mechanics. It allows you to clearly define your system and consider all forces on the system due to objects that are not part of the system itself. A number of exercises in this and subsequent chapters will help you cultivate this practice.

SUMMARY

1. Aristotle's view that a force is necessary to keep a body in uniform motion is wrong. A force is necessary in practice to counter the opposing force of friction.
2. Galileo extrapolated simple observations on motion of bodies on inclined planes, and arrived at the law of inertia. Newton's first law of motion is the same law rephrased thus: "Everybody continues to be in its state of rest or of uniform motion in a straight line, unless compelled by some external force to act otherwise". In simple terms, the First Law is "**If external force on a body is zero, its acceleration is zero**".
3. Momentum (\mathbf{p}) of a body is the product of its mass (m) and velocity (\mathbf{v}):

$$\mathbf{p} = m\mathbf{v}$$

4. Newton's second law of motion :
The rate of change of momentum of a body is proportional to the applied force and takes place in the direction in which the force acts. Thus

$$\mathbf{F} = k \frac{d\mathbf{p}}{dt} = k m \mathbf{a}$$

where \mathbf{F} is the net external force on the body and \mathbf{a} its acceleration. We set the constant of proportionality $k = 1$ in SI units. Then

$$\mathbf{F} = \frac{d\mathbf{p}}{dt} = m\mathbf{a}$$

The SI unit of force is newton : $1 \text{ N} = 1 \text{ kg m s}^{-2}$.

- (a) The second law is consistent with the First Law ($\mathbf{F} = 0$ implies $\mathbf{a} = 0$)
 - (b) It is a vector equation
 - (c) It is applicable to a particle, and also to a body or a system of particles, provided \mathbf{F} is the total external force on the system and \mathbf{a} is the acceleration of the system as a whole.
 - (d) \mathbf{F} at a point at a certain instant determines \mathbf{a} at the same point at that instant. That is the Second Law is a local law; \mathbf{a} at an instant does not depend on the history of motion.
4. Impulse is the product of force and time which equals change in momentum.
The notion of impulse is useful when a large force acts for a short time to produce a measurable change in momentum. Since the time of action of the force is very short, one can assume that there is no appreciable change in the position of the body during the action of the impulsive force.
 6. Newton's third law of motion:
To every action, there is always an equal and opposite reaction

In simple terms, the law can be stated thus :

Forces in nature always occur between pairs of bodies. Force on a body A by body B is equal and opposite to the force on the body B by A.

Action and reaction forces are simultaneous forces. There is no cause-effect relation between action and reaction. Any of the two mutual forces can be called action and the other reaction. Action and reaction act on different bodies and so they cannot be cancelled out. The internal action and reaction forces between different parts of a body do, however, sum to zero.

7. *Law of Conservation of Momentum*

The total momentum of an isolated system of particles is conserved. The law follows from the second and third law of motion.

8. *Friction*

Frictional force opposes (impending or actual) relative motion between two surfaces in contact. It is the component of the contact force along the common tangent to the surface in contact. Static friction f_s opposes impending relative motion; kinetic friction f_k opposes actual relative motion. They are independent of the area of contact and satisfy the following approximate laws :

$$f_s \leq (f_s)_{\max} = \mu_s R$$

$$f_k = \mu_k R$$

μ_s (co-efficient of static friction) and μ_k (co-efficient of kinetic friction) are constants characteristic of the pair of surfaces in contact. It is found experimentally that μ_k is less than μ_s .

| Quantity | Symbol | Units | Dimensions | Remarks |
|------------------|----------------------|-----------------------------|-----------------------|--|
| Momentum | p | kg m s ⁻¹ or N s | [MLT ⁻¹] | Vector |
| Force | F | N | [MLT ⁻²] | F = m a Second Law |
| Impulse | | kg m s ⁻¹ or N s | [M LT ⁻¹] | Impulse = force × time = change in momentum |
| Static friction | f_s | N | [MLT ⁻²] | f_s ≤ μ_s N |
| Kinetic friction | f_k | N | [MLT ⁻²] | f_k = μ_k N |

POINTS TO PONDER

- Force is not always in the direction of motion. Depending on the situation, **F** may be along **v**, opposite to **v**, normal to **v** or may make some other angle with **v**. In every case, it is parallel to acceleration.
- If **v** = 0 at an instant, i.e. if a body is momentarily at rest, it does not mean that force or acceleration are necessarily zero at that instant. For example, when a ball thrown upward reaches its maximum height, **v** = 0 but the force continues to be its weight *mg* and the acceleration is not zero but *g*.
- Force on a body at a given time is determined by the situation at the location of the body at that time. Force is not 'carried' by the body from its earlier history of motion. The moment after a stone is released out of an accelerated train, there is no horizontal force (or acceleration) on the stone, if the effects of the surrounding air are neglected. The stone then has only the vertical force of gravity.
- In the second law of motion **F** = m **a**, **F** stands for the net force due to all material agencies external to the body. **a** is the effect of the force. *ma* should not be regarded as yet another force, besides **F**.

5. The centripetal force should not be regarded as yet another kind of force. It is simply a name given to the force that provides inward radial acceleration to a body in circular motion. We should always look for some material force like tension, gravitational force, electrical force, friction, etc as the centripetal force in any circular motion.
6. Static friction is a self-adjusting force up to its limit $\mu_s N$ ($f_s \leq \mu_s N$). Do not put $f_s = \mu_s N$ without being sure that the maximum value of static friction is coming into play.
7. The familiar equation $mg = R$ for a body on a table is true only if the body is in equilibrium. The two forces mg and R can be different (e.g. a body in an accelerated lift). The equality of mg and R has no connection with the third law.
8. The terms 'action' and 'reaction' in the third Law of Motion simply stand for simultaneous mutual forces between a pair of bodies. Unlike their meaning in ordinary language, action does not precede or cause reaction. Action and reaction act on different bodies.
9. The different terms like 'friction', 'normal reaction', 'tension', 'air resistance', 'viscous drag', 'thrust', 'buoyancy', 'weight', 'centripetal force' all stand for 'force' in different contexts. For clarity, every force and its equivalent terms encountered in mechanics should be reduced to the phrase 'force on A by B'.
10. For applying the second law of motion, there is no conceptual distinction between inanimate and animate objects. An animate object such as a human also requires an external force to accelerate. For example, without the external force of friction, we cannot walk on the ground.
11. The objective concept of force in physics should not be confused with the subjective concept of the 'feeling of force'. On a merry-go-around, all parts of our body are subject to an inward force, but we have a feeling of being pushed outward – the direction of impending motion.

EXERCISES

(For simplicity in numerical calculations, take $g = 10 \text{ m s}^{-2}$)

- 4.1 Give the magnitude and direction of the net force acting on
 - (a) a drop of rain falling down with a constant speed,
 - (b) a cork of mass 10 g floating on water,
 - (c) a kite skillfully held stationary in the sky,
 - (d) a car moving with a constant velocity of 30 km/h on a rough road,
 - (e) a high-speed electron in space far from all material objects, and free of electric and magnetic fields.
 - 4.2 A pebble of mass 0.05 kg is thrown vertically upwards. Give the direction and magnitude of the net force on the pebble,
 - (a) during its upward motion,
 - (b) during its downward motion,
 - (c) at the highest point where it is momentarily at rest. Do your answers change if the pebble was thrown at an angle of 45° with the horizontal direction?
- Ignore air resistance.
- 4.3 Give the magnitude and direction of the net force acting on a stone of mass 0.1 kg,
 - (a) just after it is dropped from the window of a stationary train,
 - (b) just after it is dropped from the window of a train running at a constant velocity of 36 km/h,
 - (c) just after it is dropped from the window of a train accelerating with 1 m s^{-2} ,
 - (d) lying on the floor of a train which is accelerating with 1 m s^{-2} , the stone being at rest relative to the train.

Neglect air resistance throughout.

- 4.4** One end of a string of length l is connected to a particle of mass m and the other to a small peg on a smooth horizontal table. If the particle moves in a circle with speed v the net force on the particle (directed towards the centre) is :
- (i) T , (ii) $T - \frac{mv^2}{l}$, (iii) $T + \frac{mv^2}{l}$, (iv) 0
- T is the tension in the string. [Choose the correct alternative].
- 4.5** A constant retarding force of 50 N is applied to a body of mass 20 kg moving initially with a speed of 15 m s⁻¹. How long does the body take to stop ?
- 4.6** A constant force acting on a body of mass 3.0 kg changes its speed from 2.0 m s⁻¹ to 3.5 m s⁻¹ in 25 s. The direction of the motion of the body remains unchanged. What is the magnitude and direction of the force ?
- 4.7** A body of mass 5 kg is acted upon by two perpendicular forces 8 N and 6 N. Give the magnitude and direction of the acceleration of the body.
- 4.8** The driver of a three-wheeler moving with a speed of 36 km/h sees a child standing in the middle of the road and brings his vehicle to rest in 4.0 s just in time to save the child. What is the average retarding force on the vehicle ? The mass of the three-wheeler is 400 kg and the mass of the driver is 65 kg.
- 4.9** A rocket with a lift-off mass 20,000 kg is blasted upwards with an initial acceleration of 5.0 m s⁻². Calculate the initial thrust (force) of the blast.
- 4.10** A body of mass 0.40 kg moving initially with a constant speed of 10 m s⁻¹ to the north is subject to a constant force of 8.0 N directed towards the south for 30 s. Take the instant the force is applied to be $t = 0$, the position of the body at that time to be $x = 0$, and predict its position at $t = -5$ s, 25 s, 100 s.
- 4.11** A truck starts from rest and accelerates uniformly at 2.0 m s⁻². At $t = 10$ s, a stone is dropped by a person standing on the top of the truck (6 m high from the ground). What are the (a) velocity, and (b) acceleration of the stone at $t = 1$ s ? (Neglect air resistance.)
- 4.12** A bob of mass 0.1 kg hung from the ceiling of a room by a string 2 m long is set into oscillation. The speed of the bob at its mean position is 1 m s⁻¹. What is the trajectory of the bob if the string is cut when the bob is (a) at one of its extreme positions, (b) at its mean position.
- 4.13** A man of mass 70 kg stands on a weighing scale in a lift which is moving
- upwards with a uniform speed of 10 m s⁻¹,
 - downwards with a uniform acceleration of 5 m s⁻²,
 - upwards with a uniform acceleration of 5 m s⁻².
- What would be the readings on the scale in each case?
- (d) What would be the reading if the lift mechanism failed and it hurtled down freely under gravity ?
- 4.14** Figure 4.16 shows the position-time graph of a particle of mass 4 kg. What is the (a) force on the particle for $t < 0$, $t > 4$ s, $0 < t < 4$ s? (b) impulse at $t = 0$ and $t = 4$ s ? (Consider one-dimensional motion only).

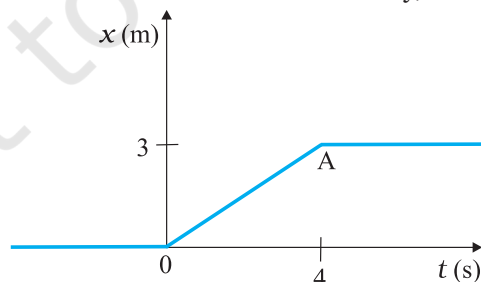

Fig. 4.16

- 4.15** Two bodies of masses 10 kg and 20 kg respectively kept on a smooth, horizontal surface are tied to the ends of a light string. A horizontal force $F = 600$ N is applied to (i) A, (ii) B along the direction of string. What is the tension in the string in each case?

- 4.16** Two masses 8 kg and 12 kg are connected at the two ends of a light inextensible string that goes over a frictionless pulley. Find the acceleration of the masses, and the tension in the string when the masses are released.
- 4.17** A nucleus is at rest in the laboratory frame of reference. Show that if it disintegrates into two smaller nuclei the products must move in opposite directions.
- 4.18** Two billiard balls each of mass 0.05 kg moving in opposite directions with speed 6 m s^{-1} collide and rebound with the same speed. What is the impulse imparted to each ball due to the other ?
- 4.19** A shell of mass 0.020 kg is fired by a gun of mass 100 kg. If the muzzle speed of the shell is 80 m s^{-1} , what is the recoil speed of the gun ?
- 4.20** A batsman deflects a ball by an angle of 45° without changing its initial speed which is equal to 54 km/h. What is the impulse imparted to the ball ? (Mass of the ball is 0.15 kg.)
- 4.21** A stone of mass 0.25 kg tied to the end of a string is whirled round in a circle of radius 1.5 m with a speed of 40 rev./min in a horizontal plane. What is the tension in the string ? What is the maximum speed with which the stone can be whirled around if the string can withstand a maximum tension of 200 N ?
- 4.22** If, in Exercise 4.21, the speed of the stone is increased beyond the maximum permissible value, and the string breaks suddenly, which of the following correctly describes the trajectory of the stone after the string breaks :
- (a) the stone moves radially outwards,
 - (b) the stone flies off tangentially from the instant the string breaks,
 - (c) the stone flies off at an angle with the tangent whose magnitude depends on the speed of the particle ?
- 4.23** Explain why
- (a) a horse cannot pull a cart and run in empty space,
 - (b) passengers are thrown forward from their seats when a speeding bus stops suddenly,
 - (c) it is easier to pull a lawn mower than to push it,
 - (d) a cricketer moves his hands backwards while holding a catch.



11086CH06

CHAPTER FIVE

WORK, ENERGY AND POWER

- 5.1 Introduction
- 5.2 Notions of work and kinetic energy : The work-energy theorem
- 5.3 Work
- 5.4 Kinetic energy
- 5.5 Work done by a variable force
- 5.6 The work-energy theorem for a variable force
- 5.7 The concept of potential energy
- 5.8 The conservation of mechanical energy
- 5.9 The potential energy of a spring
- 5.10 Power
- 5.11 Collisions
 - Summary
 - Points to ponder
 - Exercises

5.1 INTRODUCTION

The terms 'work', 'energy' and 'power' are frequently used in everyday language. A farmer ploughing the field, a construction worker carrying bricks, a student studying for a competitive examination, an artist painting a beautiful landscape, all are said to be working. In physics, however, the word 'Work' covers a definite and precise meaning. Somebody who has the capacity to work for 14-16 hours a day is said to have a large stamina or energy. We admire a long distance runner for her stamina or energy. Energy is thus our capacity to do work. In Physics too, the term 'energy' is related to work in this sense, but as said above the term 'work' itself is defined much more precisely. The word 'power' is used in everyday life with different shades of meaning. In karate or boxing we talk of 'powerful' punches. These are delivered at a great speed. This shade of meaning is close to the meaning of the word 'power' used in physics. We shall find that there is at best a loose correlation between the physical definitions and the physiological pictures these terms generate in our minds. The aim of this chapter is to develop an understanding of these three physical quantities. Before we proceed to this task, we need to develop a mathematical prerequisite, namely the scalar product of two vectors.

5.1.1 The Scalar Product

We have learnt about vectors and their use in Chapter 3. Physical quantities like displacement, velocity, acceleration, force etc. are vectors. We have also learnt how vectors are added or subtracted. We now need to know how vectors are multiplied. There are two ways of multiplying vectors which we shall come across : one way known as the scalar product gives a scalar from two vectors and the other known as the vector product produces a new vector from two vectors. We shall look at the vector product in Chapter 6. Here we take up the scalar product of two vectors. The scalar product or dot product of any two vectors \mathbf{A} and \mathbf{B} , denoted as $\mathbf{A} \cdot \mathbf{B}$ (read

\mathbf{A} dot \mathbf{B}) is defined as

$$\mathbf{A} \cdot \mathbf{B} = AB \cos \theta \quad (5.1a)$$

where θ is the angle between the two vectors as shown in Fig. 5.1(a). Since A , B and $\cos \theta$ are scalars, the dot product of \mathbf{A} and \mathbf{B} is a scalar quantity. Each vector, \mathbf{A} and \mathbf{B} , has a direction but their scalar product does not have a direction.

From Eq. (5.1a), we have

$$\begin{aligned} \mathbf{A} \cdot \mathbf{B} &= A (B \cos \theta) \\ &= B (A \cos \theta) \end{aligned}$$

Geometrically, $B \cos \theta$ is the projection of \mathbf{B} onto \mathbf{A} in Fig. 5.1 (b) and $A \cos \theta$ is the projection of \mathbf{A} onto \mathbf{B} in Fig. 5.1 (c). So, $\mathbf{A} \cdot \mathbf{B}$ is the product of the magnitude of \mathbf{A} and the component of \mathbf{B} along \mathbf{A} . Alternatively, it is the product of the magnitude of \mathbf{B} and the component of \mathbf{A} along \mathbf{B} .

Equation (5.1a) shows that the scalar product follows the commutative law :

$$\mathbf{A} \cdot \mathbf{B} = \mathbf{B} \cdot \mathbf{A}$$

Scalar product obeys the **distributive law**:

$$\mathbf{A} \cdot (\mathbf{B} + \mathbf{C}) = \mathbf{A} \cdot \mathbf{B} + \mathbf{A} \cdot \mathbf{C}$$

Further, $\mathbf{A} \cdot (\lambda \mathbf{B}) = \lambda (\mathbf{A} \cdot \mathbf{B})$

where λ is a real number.

The proofs of the above equations are left to you as an exercise.

For unit vectors $\hat{\mathbf{i}}, \hat{\mathbf{j}}, \hat{\mathbf{k}}$ we have

$$\begin{aligned} \hat{\mathbf{i}} \cdot \hat{\mathbf{i}} &= \hat{\mathbf{j}} \cdot \hat{\mathbf{j}} = \hat{\mathbf{k}} \cdot \hat{\mathbf{k}} = 1 \\ \hat{\mathbf{i}} \cdot \hat{\mathbf{j}} &= \hat{\mathbf{j}} \cdot \hat{\mathbf{k}} = \hat{\mathbf{k}} \cdot \hat{\mathbf{i}} = 0 \end{aligned}$$

Given two vectors

$$\mathbf{A} = A_x \hat{\mathbf{i}} + A_y \hat{\mathbf{j}} + A_z \hat{\mathbf{k}}$$

$$\mathbf{B} = B_x \hat{\mathbf{i}} + B_y \hat{\mathbf{j}} + B_z \hat{\mathbf{k}}$$

their scalar product is

$$\begin{aligned} \mathbf{A} \cdot \mathbf{B} &= (A_x \hat{\mathbf{i}} + A_y \hat{\mathbf{j}} + A_z \hat{\mathbf{k}}) \cdot (B_x \hat{\mathbf{i}} + B_y \hat{\mathbf{j}} + B_z \hat{\mathbf{k}}) \\ &= A_x B_x + A_y B_y + A_z B_z \end{aligned} \quad (5.1b)$$

From the definition of scalar product and (Eq. 5.1b) we have :

$$(i) \quad \mathbf{A} \cdot \mathbf{A} = A_x A_x + A_y A_y + A_z A_z$$

$$\text{Or,} \quad A^2 = A_x^2 + A_y^2 + A_z^2 \quad (5.1c)$$

since $\mathbf{A} \cdot \mathbf{A} = |\mathbf{A}| |\mathbf{A}| \cos 0 = A^2$.

(ii) $\mathbf{A} \cdot \mathbf{B} = 0$, if \mathbf{A} and \mathbf{B} are perpendicular.

► **Example 5.1** Find the angle between force $\mathbf{F} = (3\hat{\mathbf{i}} + 4\hat{\mathbf{j}} - 5\hat{\mathbf{k}})$ unit and displacement $\mathbf{d} = (5\hat{\mathbf{i}} + 4\hat{\mathbf{j}} + 3\hat{\mathbf{k}})$ unit. Also find the projection of \mathbf{F} on \mathbf{d} .

$$\begin{aligned} \text{Answer } \mathbf{F} \cdot \mathbf{d} &= F_x d_x + F_y d_y + F_z d_z \\ &= 3(5) + 4(4) + (-5)(3) \\ &= 16 \text{ unit} \end{aligned}$$

$$\text{Hence } \mathbf{F} \cdot \mathbf{d} = F d \cos \theta = 16 \text{ unit}$$

$$\begin{aligned} \text{Now } \mathbf{F} \cdot \mathbf{F} &= F^2 = F_x^2 + F_y^2 + F_z^2 \\ &= 9 + 16 + 25 \\ &= 50 \text{ unit} \end{aligned}$$

$$\begin{aligned} \text{and } \mathbf{d} \cdot \mathbf{d} &= d^2 = d_x^2 + d_y^2 + d_z^2 \\ &= 25 + 16 + 9 \\ &= 50 \text{ unit} \end{aligned}$$

$$\begin{aligned} \therefore \cos \theta &= \frac{16}{\sqrt{50}\sqrt{50}} = \frac{16}{50} = 0.32, \\ \theta &= \cos^{-1} 0.32 \end{aligned}$$

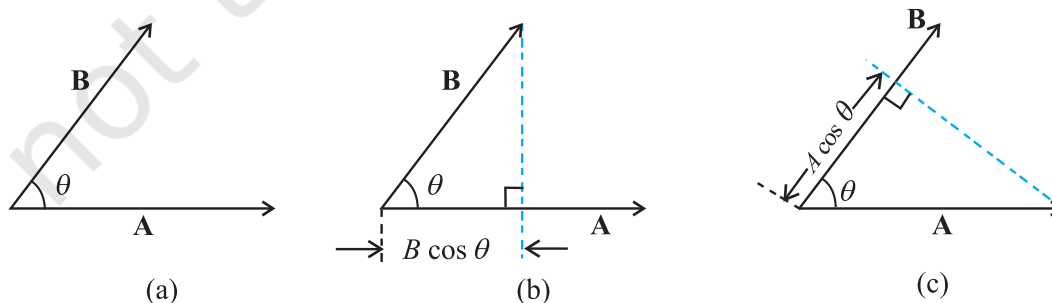

Fig. 5.1 (a) The scalar product of two vectors \mathbf{A} and \mathbf{B} is a scalar : $\mathbf{A} \cdot \mathbf{B} = AB \cos \theta$. (b) $B \cos \theta$ is the projection of \mathbf{B} onto \mathbf{A} . (c) $A \cos \theta$ is the projection of \mathbf{A} onto \mathbf{B} .

5.2 NOTIONS OF WORK AND KINETIC ENERGY: THE WORK-ENERGY THEOREM

The following relation for rectilinear motion under constant acceleration a has been encountered in Chapter 3,

$$v^2 - u^2 = 2 as \quad (5.2)$$

where u and v are the initial and final speeds and s the distance traversed. Multiplying both sides by $m/2$, we have

$$\frac{1}{2}mv^2 - \frac{1}{2}mu^2 = mas = Fs \quad (5.2a)$$

where the last step follows from Newton's Second Law. We can generalise Eq. (5.2) to three dimensions by employing vectors

$$v^2 - u^2 = 2 \mathbf{a} \cdot \mathbf{d}$$

Here \mathbf{a} and \mathbf{d} are acceleration and displacement vectors of the object respectively.

Once again multiplying both sides by $m/2$, we obtain

$$\frac{1}{2}mv^2 - \frac{1}{2}mu^2 = m \mathbf{a} \cdot \mathbf{d} = \mathbf{F} \cdot \mathbf{d} \quad (5.2b)$$

The above equation provides a motivation for the definitions of work and kinetic energy. The left side of the equation is the difference in the quantity 'half the mass times the square of the speed' from its initial value to its final value. We call each of these quantities the 'kinetic energy', denoted by K . The right side is a product of the displacement and the component of the force along the displacement. This quantity is called 'work' and is denoted by W . Eq. (5.2b) is then

$$K_f - K_i = W \quad (5.3)$$

where K_i and K_f are respectively the initial and final kinetic energies of the object. Work refers to the force and the displacement over which it acts. **Work is done by a force on the body over a certain displacement.**

Equation (5.2) is also a special case of the work-energy (WE) theorem: **The change in kinetic energy of a particle is equal to the work done on it by the net force.** We shall generalise the above derivation to a varying force in a later section.

Example 5.2 It is well known that a raindrop falls under the influence of the downward gravitational force and the opposing resistive force. The latter is known

to be proportional to the speed of the drop but is otherwise undetermined. Consider a drop of mass 1.00 g falling from a height 1.00 km. It hits the ground with a speed of 50.0 m s⁻¹. (a) What is the work done by the gravitational force? What is the work done by the unknown resistive force?

Answer (a) The change in kinetic energy of the drop is

$$\begin{aligned} \Delta K &= \frac{1}{2}m v^2 - 0 \\ &= \frac{1}{2} \times 10^{-3} \times 50 \times 50 \\ &= 1.25 \text{ J} \end{aligned}$$

where we have assumed that the drop is initially at rest.

Assuming that g is a constant with a value 10 m/s², the work done by the gravitational force is,

$$\begin{aligned} W_g &= mgh \\ &= 10^{-3} \times 10 \times 10^3 \\ &= 10.0 \text{ J} \end{aligned}$$

(b) From the work-energy theorem

$$\Delta K = W_g + W_r$$

where W_r is the work done by the resistive force on the raindrop. Thus

$$\begin{aligned} W_r &= \Delta K - W_g \\ &= 1.25 - 10 \\ &= -8.75 \text{ J} \end{aligned}$$

is negative. ▶

5.3 WORK

As seen earlier, work is related to force and the displacement over which it acts. Consider a constant force \mathbf{F} acting on an object of mass m . The object undergoes a displacement \mathbf{d} in the positive x -direction as shown in Fig. 5.2.

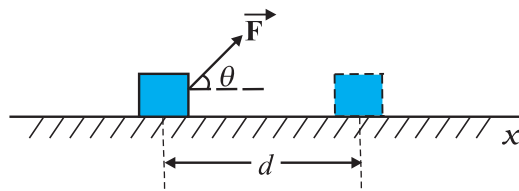

Fig. 5.2 An object undergoes a displacement \mathbf{d} under the influence of the force \mathbf{F} .

The work done by the force is defined to be the product of component of the force in the direction of the displacement and the magnitude of this displacement. Thus

$$W = (F \cos \theta)d = \mathbf{F} \cdot \mathbf{d} \quad (5.4)$$

We see that if there is no displacement, there is no work done even if the force is large. Thus, when you push hard against a rigid brick wall, the force you exert on the wall does no work. Yet your muscles are alternatively contracting and relaxing and internal energy is being used up and you do get tired. Thus, the meaning of work in physics is different from its usage in everyday language.

No work is done if :

- (i) the displacement is zero as seen in the example above. A weightlifter holding a 150 kg mass steadily on his shoulder for 30 s does no work on the load during this time.
- (ii) the force is zero. A block moving on a smooth horizontal table is not acted upon by a horizontal force (since there is no friction), but may undergo a large displacement.
- (iii) the force and displacement are mutually perpendicular. This is so since, for $\theta = \pi/2$ rad ($= 90^\circ$), $\cos(\pi/2) = 0$. For the block moving on a smooth horizontal table, the gravitational force mg does no work since it acts at right angles to the displacement. If we assume that the moon's orbits around the earth is perfectly circular then the earth's gravitational force does no work. The moon's instantaneous displacement is tangential while the earth's force is radially inwards and $\theta = \pi/2$.

Work can be both positive and negative. If θ is between 0° and 90° , $\cos \theta$ in Eq. (5.4) is positive. If θ is between 90° and 180° , $\cos \theta$ is negative. In many examples the frictional force opposes displacement and $\theta = 180^\circ$. Then the work done by friction is negative ($\cos 180^\circ = -1$).

From Eq. (5.4) it is clear that work and energy have the same dimensions, $[ML^2T^{-2}]$. The SI unit of these is joule (J), named after the famous British physicist James Prescott Joule (1811-1869). Since work and energy are so widely used as physical concepts, alternative units abound and some of these are listed in Table 5.1.

Table 5.1 Alternative Units of Work/Energy in J

| | |
|---------------------|-------------------------|
| erg | 10^{-7} J |
| electron volt (eV) | 1.6×10^{-19} J |
| calorie (cal) | 4.186 J |
| kilowatt hour (kWh) | 3.6×10^6 J |

Example 5.3 A cyclist comes to a skidding stop in 10 m. During this process, the force on the cycle due to the road is 200 N and is directly opposed to the motion. (a) How much work does the road do on the cycle? (b) How much work does the cycle do on the road?

Answer Work done on the cycle by the road is the work done by the stopping (frictional) force on the cycle due to the road.

- (a) The stopping force and the displacement make an angle of 180° (π rad) with each other. Thus, work done by the road,

$$\begin{aligned} W_r &= Fd \cos \theta \\ &= 200 \times 10 \times \cos \pi \\ &= -2000 \text{ J} \end{aligned}$$

It is this negative work that brings the cycle to a halt in accordance with WE theorem.

- (b) From Newton's Third Law an equal and opposite force acts on the road due to the cycle. Its magnitude is 200 N. However, the road undergoes no displacement. Thus, work done by cycle on the road is zero. ◀

The lesson of Example 5.3 is that though the force on a body A exerted by the body B is always equal and opposite to that on B by A (Newton's Third Law); the work done on A by B is not necessarily equal and opposite to the work done on B by A.

5.4 KINETIC ENERGY

As noted earlier, if an object of mass m has velocity \mathbf{v} , its kinetic energy K is

$$K = \frac{1}{2} m \mathbf{v} \cdot \mathbf{v} = \frac{1}{2} mv^2 \quad (5.5)$$

Kinetic energy is a scalar quantity. The kinetic energy of an object is a measure of the work an

Table 5.2 Typical kinetic energies (K)

| Object | Mass (kg) | Speed (m s ⁻¹) | K (J) |
|-----------------------------|------------------------|----------------------------|------------------------|
| Car | 2000 | 25 | 6.3 × 10 ⁵ |
| Running athlete | 70 | 10 | 3.5 × 10 ³ |
| Bullet | 5 × 10 ⁻² | 200 | 10 ³ |
| Stone dropped from 10 m | 1 | 14 | 10 ² |
| Rain drop at terminal speed | 3.5 × 10 ⁻⁵ | 9 | 1.4 × 10 ⁻³ |
| Air molecule | ≈ 10 ⁻²⁶ | 500 | ≈ 10 ⁻²¹ |

object can do by the virtue of its motion. This notion has been intuitively known for a long time. The kinetic energy of a fast flowing stream has been used to grind corn. Sailing ships employ the kinetic energy of the wind. Table 5.2 lists the kinetic energies for various objects.

► **Example 5.4** In a ballistics demonstration a police officer fires a bullet of mass 50.0 g with speed 200 m s⁻¹ (see Table 5.2) on soft plywood of thickness 2.00 cm. The bullet emerges with only 10% of its initial kinetic energy. What is the emergent speed of the bullet?

Answer The initial kinetic energy of the bullet is $mv^2/2 = 1000$ J. It has a final kinetic energy of $0.1 \times 1000 = 100$ J. If v_f is the emergent speed of the bullet,

$$\begin{aligned} \frac{1}{2}mv_f^2 &= 100 \text{ J} \\ v_f &= \sqrt{\frac{2 \times 100 \text{ J}}{0.05 \text{ kg}}} \\ &= 63.2 \text{ m s}^{-1} \end{aligned}$$

The speed is reduced by approximately 68% (not 90%). ◀

5.5 WORK DONE BY A VARIABLE FORCE

A constant force is rare. It is the variable force, which is more commonly encountered. Fig. 5.3 is a plot of a varying force in one dimension.

If the displacement Δx is small, we can take the force $F(x)$ as approximately constant and the work done is then

$$\Delta W = F(x) \Delta x$$

This is illustrated in Fig. 5.3(a). Adding successive rectangular areas in Fig. 5.3(a) we get the total work done as

$$W \equiv \sum_{x_i}^{x_f} F(x) \Delta x \quad (5.6)$$

where the summation is from the initial position x_i to the final position x_f .

If the displacements are allowed to approach zero, then the number of terms in the sum increases without limit, but the sum approaches a definite value equal to the area under the curve in Fig. 5.3(b). Then the work done is

$$\begin{aligned} W &= \lim_{\Delta x \rightarrow 0} \sum_{x_i}^{x_f} F(x) \Delta x \\ &= \int_{x_i}^{x_f} F(x) dx \end{aligned} \quad (5.7)$$

where 'lim' stands for the limit of the sum when Δx tends to zero. Thus, for a varying force the work done can be expressed as a definite integral of force over displacement (see also Appendix 3.1).

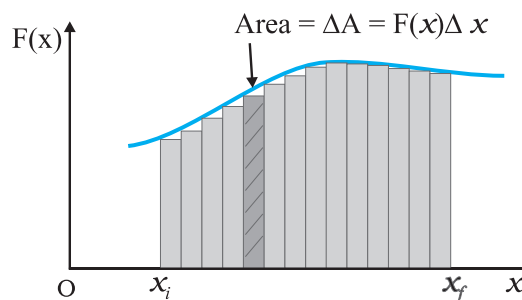
Fig. 5.3(a)

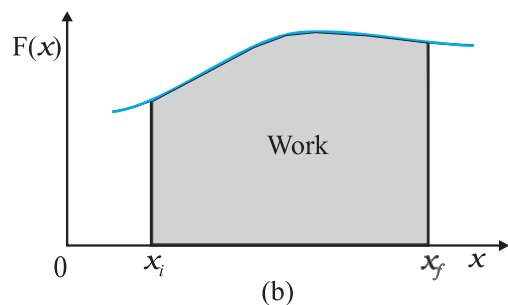

Fig. 5.3 (a) The shaded rectangle represents the work done by the varying force $F(x)$, over the small displacement Δx , $\Delta W = F(x) \Delta x$. (b) adding the areas of all the rectangles we find that for $\Delta x \rightarrow 0$, the area under the curve is exactly equal to the work done by $F(x)$.

► **Example 5.5** A woman pushes a trunk on a railway platform which has a rough surface. She applies a force of 100 N over a distance of 10 m. Thereafter, she gets progressively tired and her applied force reduces linearly with distance to 50 N. The total distance through which the trunk has been moved is 20 m. Plot the force applied by the woman and the frictional force, which is 50 N versus displacement. Calculate the work done by the two forces over 20 m.

Answer

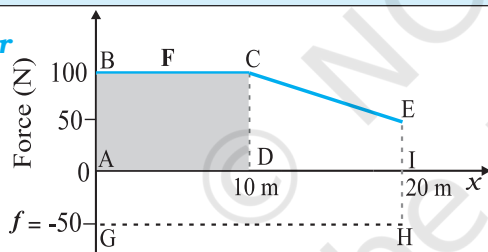

Fig. 5.4 Plot of the force F applied by the woman and the opposing frictional force f versus displacement.

The plot of the applied force is shown in Fig. 5.4. At $x = 20$ m, $F = 50$ N ($\neq 0$). We are given that the frictional force f is $|\mathbf{f}| = 50$ N. It opposes motion and acts in a direction opposite to \mathbf{F} . It is therefore, shown on the negative side of the force axis.

The work done by the woman is

$W_F \rightarrow$ area of the rectangle ABCD + area of the trapezium CEID

$$\begin{aligned} W_F &= 100 \times 10 + \frac{1}{2}(100 + 50) \times 10 \\ &= 1000 + 750 \\ &= 1750 \text{ J} \end{aligned}$$

The work done by the frictional force is

$$\begin{aligned} W_f &\rightarrow \text{area of the rectangle AGHI} \\ W_f &= (-50) \times 20 \\ &= -1000 \text{ J} \end{aligned}$$

The area on the negative side of the force axis has a negative sign. ◀

5.6 THE WORK-ENERGY THEOREM FOR A VARIABLE FORCE

We are now familiar with the concepts of work and kinetic energy to prove the work-energy theorem for a variable force. We confine ourselves to one dimension. The time rate of change of kinetic energy is

$$\frac{dK}{dt} = \frac{d}{dt} \left(\frac{1}{2} m v^2 \right)$$

$$= m \frac{dv}{dt} v$$

$$= F v \text{ (from Newton's Second Law)}$$

$$= F \frac{dx}{dt}$$

Thus

$$dK = F dx$$

Integrating from the initial position (x_i) to final position (x_f), we have

$$\int_{K_i}^{K_f} dK = \int_{x_i}^{x_f} F dx$$

where, K_i and K_f are the initial and final kinetic energies corresponding to x_i and x_f .

$$\text{or} \quad K_f - K_i = \int_{x_i}^{x_f} F dx \quad (5.8a)$$

From Eq. (5.7), it follows that

$$K_f - K_i = W \quad (5.8b)$$

Thus, the WE theorem is proved for a variable force.

While the WE theorem is useful in a variety of problems, it does not, in general, incorporate the complete dynamical information of Newton's second law. It is an integral form of Newton's second law. Newton's second law is a relation between acceleration and force at any instant of time. Work-energy theorem involves an integral over an interval of time. In this sense, the temporal (time) information contained in the statement of Newton's second law is 'integrated over' and is

not available explicitly. Another observation is that Newton's second law for two or three dimensions is in vector form whereas the work-energy theorem is in scalar form. In the scalar form, information with respect to directions contained in Newton's second law is not present.

► **Example 5.6** A block of mass $m = 1$ kg, moving on a horizontal surface with speed $v_i = 2$ m s⁻¹ enters a rough patch ranging from $x = 0.10$ m to $x = 2.01$ m. The retarding force F_r on the block in this range is inversely proportional to x over this range,

$$F_r = \frac{-k}{x} \text{ for } 0.1 < x < 2.01 \text{ m}$$

$$= 0 \text{ for } x < 0.1 \text{ m and } x > 2.01 \text{ m}$$

where $k = 0.5$ J. What is the final kinetic energy and speed v_f of the block as it crosses this patch?

Answer From Eq. (5.8a)

$$K_f = K_i + \int_{0.1}^{2.01} \frac{(-k)}{x} dx$$

$$= \frac{1}{2} m v_i^2 - k \ln(x) \Big|_{0.1}^{2.01}$$

$$= \frac{1}{2} m v_i^2 - k \ln(2.01/0.1)$$

$$= 2 - 0.5 \ln(20.1)$$

$$= 2 - 1.5 = 0.5 \text{ J}$$

$$v_f = \sqrt{2K_f/m} = 1 \text{ m s}^{-1}$$

Here, note that \ln is a symbol for the natural logarithm to the base e and not the logarithm to the base 10 [$\ln X = \log_e X = 2.303 \log_{10} X$]. ◀

5.7 THE CONCEPT OF POTENTIAL ENERGY

The word potential suggests possibility or capacity for action. The term potential energy brings to one's mind 'stored' energy. A stretched bow-string possesses potential energy. When it is released, the arrow flies off at a great speed. The earth's crust is not uniform, but has discontinuities and dislocations that are called fault lines. These fault lines in the earth's crust

are like 'compressed springs'. They possess a large amount of potential energy. An earthquake results when these fault lines readjust. Thus, potential energy is the 'stored energy' by virtue of the position or configuration of a body. The body left to itself releases this stored energy in the form of kinetic energy. Let us make our notion of potential energy more concrete.

The gravitational force on a ball of mass m is mg . g may be treated as a constant near the earth surface. By 'near' we imply that the height h of the ball above the earth's surface is very small compared to the earth's radius R_E ($h \ll R_E$) so that we can ignore the variation of g near the earth's surface*. In what follows we have taken the upward direction to be positive. Let us raise the ball up to a height h . The work done by the external agency against the gravitational force is mgh . This work gets stored as potential energy. Gravitational potential energy of an object, as a function of the height h , is denoted by $V(h)$ and it is the negative of work done by the gravitational force in raising the object to that height.

$$V(h) = mgh$$

If h is taken as a variable, it is easily seen that the gravitational force F equals the negative of the derivative of $V(h)$ with respect to h . Thus,

$$F = -\frac{d}{dh} V(h) = -mg$$

The negative sign indicates that the gravitational force is downward. When released, the ball comes down with an increasing speed. Just before it hits the ground, its speed is given by the kinematic relation,

$$v^2 = 2gh$$

This equation can be written as

$$\frac{1}{2} m v^2 = m g h$$

which shows that the gravitational potential energy of the object at height h , when the object is released, manifests itself as kinetic energy of the object on reaching the ground.

Physically, the notion of potential energy is applicable only to the class of forces where work done against the force gets 'stored up' as energy. When external constraints are removed, it manifests itself as kinetic energy. Mathematically, (for simplicity, in one dimension) the potential

* The variation of g with height is discussed in Chapter 7 on Gravitation.

energy $V(x)$ is defined if the force $F(x)$ can be written as

$$F(x) = -\frac{dV}{dx}$$

This implies that

$$\int_{x_i}^{x_f} F(x)dx = -\int_{V_i}^{V_f} dV = V_i - V_f$$

The work done by a conservative force such as gravity depends on the initial and final positions only. In the previous chapter we have worked on examples dealing with inclined planes. If an object of mass m is released from rest, from the top of a smooth (frictionless) inclined plane of height h , its speed at the bottom is $\sqrt{2gh}$ irrespective of the angle of inclination. Thus, at the bottom of the inclined plane it acquires a kinetic energy, mgh . If the work done or the kinetic energy did depend on other factors such as the velocity or the particular path taken by the object, the force would be called non-conservative.

The dimensions of potential energy are $[ML^2T^{-2}]$ and the unit is joule (J), the same as kinetic energy or work. To reiterate, the change in potential energy, for a conservative force, ΔV is equal to the negative of the work done by the force

$$\Delta V = -F(x) \Delta x \quad (5.9)$$

In the example of the falling ball considered in this section we saw how potential energy was converted to kinetic energy. This hints at an important principle of conservation in mechanics, which we now proceed to examine.

5.8 THE CONSERVATION OF MECHANICAL ENERGY

For simplicity we demonstrate this important principle for one-dimensional motion. Suppose that a body undergoes displacement Δx under the action of a conservative force F . Then from the WE theorem we have,

$$\Delta K = F(x) \Delta x$$

If the force is conservative, the potential energy function $V(x)$ can be defined such that

$$-\Delta V = F(x) \Delta x$$

The above equations imply that

$$\begin{aligned} \Delta K + \Delta V &= 0 \\ \Delta(K + V) &= 0 \end{aligned} \quad (5.10)$$

which means that $K + V$, the sum of the kinetic and potential energies of the body is a constant. Over the whole path, x_i to x_f , this means that

$$K_i + V(x_i) = K_f + V(x_f) \quad (5.11)$$

The quantity $K + V(x)$, is called the total mechanical energy of the system. Individually the kinetic energy K and the potential energy $V(x)$ may vary from point to point, but the sum is a constant. The aptness of the term 'conservative force' is now clear.

Let us consider some of the definitions of a conservative force.

- A force $F(x)$ is conservative if it can be derived from a scalar quantity $V(x)$ by the relation given by Eq. (5.9). The three-dimensional generalisation requires the use of a vector derivative, which is outside the scope of this book.

- The work done by the conservative force depends only on the end points. This can be seen from the relation,

$$W = K_f - K_i = V(x_i) - V(x_f)$$

which depends on the end points.

- A third definition states that the work done by this force in a closed path is zero. This is once again apparent from Eq. (5.11) since $x_i = x_f$.

Thus, the principle of conservation of total mechanical energy can be stated as

The total mechanical energy of a system is conserved if the forces, doing work on it, are conservative.

The above discussion can be made more concrete by considering the example of the gravitational force once again and that of the spring force in the next section. Fig. 5.5 depicts a ball of mass m being dropped from a cliff of height H .

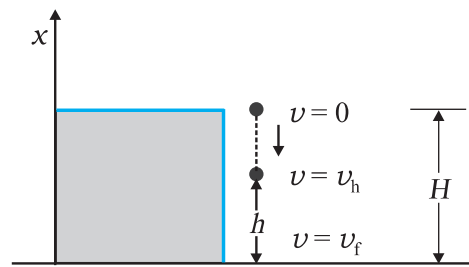

Fig. 5.5 The conversion of potential energy to kinetic energy for a ball of mass m dropped from a height H .

The total mechanical energies E_0 , E_h , and E_H of the ball at the indicated heights zero (ground level), h and H , are

$$E_H = mgH \quad (5.11 \text{ a})$$

$$E_h = mgh + \frac{1}{2}mv_h^2 \quad (5.11 \text{ b})$$

$$E_0 = (1/2)mv_f^2 \quad (5.11 \text{ c})$$

The constant force is a special case of a spatially dependent force $F(x)$. Hence, the mechanical energy is conserved. Thus

$$E_H = E_0$$

or,
$$mgH = \frac{1}{2}mv_f^2$$

$$v_f = \sqrt{2gH}$$

a result that was obtained in section 5.7 for a freely falling body.

Further,

$$E_H = E_h$$

which implies,

$$v_h^2 = 2g(H - h) \quad (5.11 \text{ d})$$

and is a familiar result from kinematics.

At the height H , the energy is purely potential. It is partially converted to kinetic at height h and is fully kinetic at ground level. This illustrates the conservation of mechanical energy.

► **Example 5.7** A bob of mass m is suspended by a light string of length L . It is imparted a horizontal velocity v_0 at the lowest point A such that it completes a semi-circular trajectory in the vertical plane with the string becoming slack only on reaching the topmost point, C. This is shown in Fig. 5.6. Obtain an expression for (i) v_0 ; (ii) the speeds at points B and C; (iii) the ratio of the kinetic energies (K_B/K_C) at B and C. Comment on the nature of the trajectory of the bob after it reaches the point C.

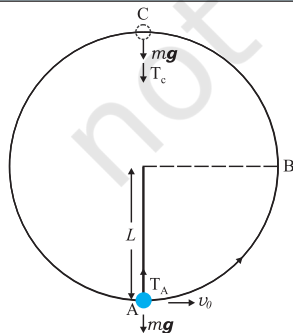

Fig. 5.6

Answer (i) There are two external forces on the bob : gravity and the tension (T) in the string. The latter does no work since the displacement of the bob is always normal to the string. The potential energy of the bob is thus associated with the gravitational force only. The total mechanical energy E of the system is conserved. We take the potential energy of the system to be zero at the lowest point A. Thus, at A :

$$E = \frac{1}{2}mv_0^2 \quad (5.12)$$

$$T_A - mg = \frac{mv_0^2}{L} \text{ [Newton's Second Law]}$$

where T_A is the tension in the string at A. At the highest point C, the string slackens, as the tension in the string (T_C) becomes zero.

Thus, at C

$$E = \frac{1}{2}mv_c^2 + 2mgL \quad (5.13)$$

$$mg = \frac{mv_c^2}{L} \text{ [Newton's Second Law]} \quad (5.14)$$

where v_c is the speed at C. From Eqs. (5.13) and (5.14)

$$E = \frac{5}{2}mgL$$

Equating this to the energy at A

$$\frac{5}{2}mgL = \frac{m}{2}v_0^2$$

or,
$$v_0 = \sqrt{5gL}$$

(ii) It is clear from Eq. (5.14)

$$v_c = \sqrt{gL}$$

At B, the energy is

$$E = \frac{1}{2}mv_B^2 + mgL$$

Equating this to the energy at A and employing the result from (i), namely $v_0^2 = 5gL$,

$$\frac{1}{2}mv_B^2 + mgL = \frac{1}{2}mv_0^2$$

$$= \frac{5}{2}m g L$$

$$\therefore v_B = \sqrt{3gL}$$

(iii) The ratio of the kinetic energies at B and C is :

$$\frac{K_B}{K_C} = \frac{\frac{1}{2}mv_B^2}{\frac{1}{2}mv_C^2} = \frac{3}{1}$$

At point C, the string becomes slack and the velocity of the bob is horizontal and to the left. If the connecting string is cut at this instant, the bob will execute a projectile motion with horizontal projection akin to a rock kicked horizontally from the edge of a cliff. Otherwise the bob will continue on its circular path and complete the revolution. \blacktriangleleft

5.9 THE POTENTIAL ENERGY OF A SPRING

The spring force is an example of a variable force which is conservative. Fig. 5.7 shows a block attached to a spring and resting on a smooth horizontal surface. The other end of the spring is attached to a rigid wall. The spring is light and may be treated as massless. In an ideal spring, the spring force F_s is proportional to x where x is the displacement of the block from the equilibrium position. The displacement could be either positive [Fig. 5.7(b)] or negative [Fig. 5.7(c)]. This force law for the spring is called Hooke's law and is mathematically stated as

$$F_s = -kx$$

The constant k is called the spring constant. Its unit is N m^{-1} . The spring is said to be stiff if k is large and soft if k is small.

Suppose that we pull the block outwards as in Fig. 5.7(b). If the extension is x_m , the work done by the spring force is

$$\begin{aligned} W_s &= \int_0^{x_m} F_s \, dx = - \int_0^{x_m} kx \, dx \\ &= - \frac{kx_m^2}{2} \end{aligned} \quad (5.15)$$

This expression may also be obtained by considering the area of the triangle as in Fig. 5.7(d). Note that the work done by the external pulling force F is positive since it overcomes the spring force.

$$W = + \frac{kx_m^2}{2} \quad (5.16)$$

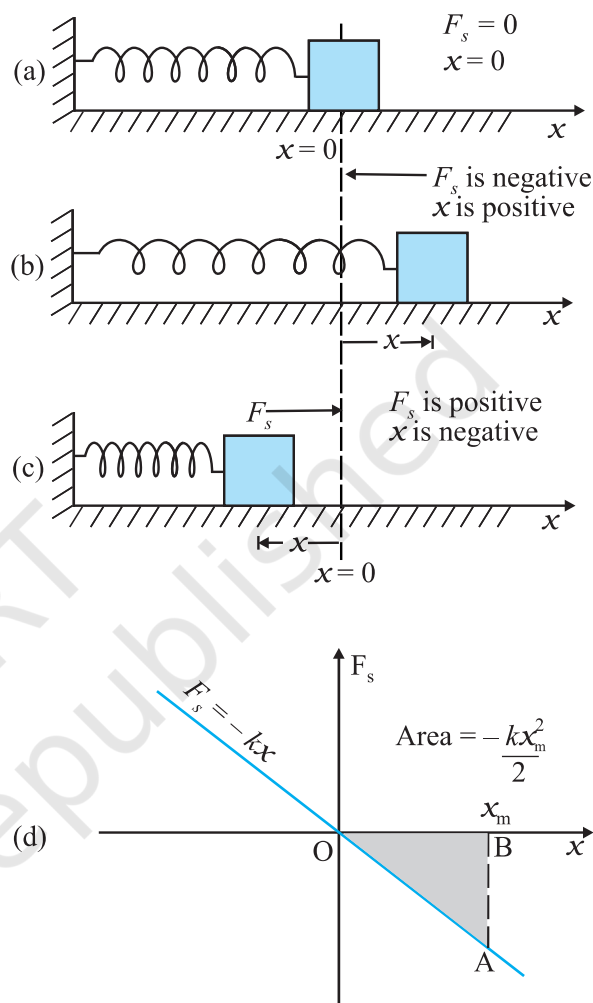

Fig. 5.7 Illustration of the spring force with a block attached to the free end of the spring. (a) The spring force F_s is zero when the displacement x from the equilibrium position is zero. (b) For the stretched spring $x > 0$ and $F_s < 0$ (c) For the compressed spring $x < 0$ and $F_s > 0$. (d) The plot of F_s versus x . The area of the shaded triangle represents the work done by the spring force. Due to the opposing signs of F_s and x , this work done is negative, $W_s = -kx_m^2 / 2$.

The same is true when the spring is compressed with a displacement $x_c (< 0)$. The spring force does work $W_s = -kx_c^2 / 2$ while the

external force F does work $+kx_c^2/2$. If the block is moved from an initial displacement x_i to a final displacement x_f , the work done by the spring force W_s is

$$W_s = -\int_{x_i}^{x_f} kx \, dx = \frac{kx_i^2}{2} - \frac{kx_f^2}{2} \quad (5.17)$$

Thus the work done by the spring force depends only on the end points. Specifically, if the block is pulled from x_i and allowed to return to x_i ;

$$\begin{aligned} W_s &= -\int_{x_i}^{x_i} kx \, dx = \frac{kx_i^2}{2} - \frac{kx_i^2}{2} \\ &= 0 \end{aligned} \quad (5.18)$$

The work done by the spring force in a cyclic process is zero. We have explicitly demonstrated that the spring force (i) is position dependent only as first stated by Hooke, ($F_s = -kx$); (ii) does work which only depends on the initial and final positions, e.g. Eq. (5.17). Thus, the spring force is a **conservative force**.

We define the potential energy $V(x)$ of the spring to be zero when block and spring system is in the equilibrium position. For an extension (or compression) x the above analysis suggests that

$$V(x) = \frac{kx^2}{2} \quad (5.19)$$

You may easily verify that $-dV/dx = -kx$, the spring force. If the block of mass m in Fig. 5.7 is extended to x_m and released from rest, then its total mechanical energy at any arbitrary point x , where x lies between $-x_m$ and $+x_m$, will be given by

$$\frac{1}{2}kx_m^2 = \frac{1}{2}kx^2 + \frac{1}{2}mv^2$$

where we have invoked the conservation of mechanical energy. This suggests that the speed and the kinetic energy will be maximum at the equilibrium position, $x = 0$, i.e.,

$$\frac{1}{2}mv_m^2 = \frac{1}{2}kx_m^2$$

where v_m is the maximum speed.

$$\text{or } v_m = \sqrt{\frac{k}{m}} x_m$$

Note that k/m has the dimensions of $[T^{-2}]$ and our equation is dimensionally correct. The kinetic energy gets converted to potential energy

and vice versa, however, the total mechanical energy remains constant. This is graphically depicted in Fig. 5.8.

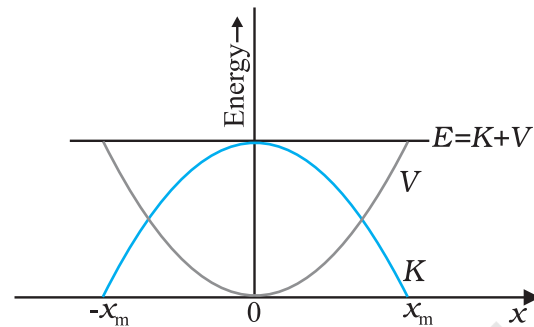

Fig. 5.8 Parabolic plots of the potential energy V and kinetic energy K of a block attached to a spring obeying Hooke's law. The two plots are complementary, one decreasing as the other increases. The total mechanical energy $E = K + V$ remains constant.

► **Example 5.8** To simulate car accidents, auto manufacturers study the collisions of moving cars with mounted springs of different spring constants. Consider a typical simulation with a car of mass 1000 kg moving with a speed 18.0 km/h on a smooth road and colliding with a horizontally mounted spring of spring constant $5.25 \times 10^3 \text{ N m}^{-1}$. What is the maximum compression of the spring?

Answer At maximum compression the kinetic energy of the car is converted entirely into the potential energy of the spring.

The kinetic energy of the moving car is

$$\begin{aligned} K &= \frac{1}{2}mv^2 \\ &= \frac{1}{2} \times 10^3 \times 5 \times 5 \end{aligned}$$

$$K = 1.25 \times 10^4 \text{ J}$$

where we have converted 18 km h^{-1} to 5 m s^{-1} **[It is useful to remember that $36 \text{ km h}^{-1} = 10 \text{ m s}^{-1}$]**. At maximum compression x_m , the potential energy V of the spring is equal to the kinetic energy K of the moving car from the principle of conservation of mechanical energy.

$$V = \frac{1}{2}kx_m^2$$

$$= 1.25 \times 10^4 \text{ J}$$

We obtain

$$x_m = 2.00 \text{ m}$$

We note that we have idealised the situation. The spring is considered to be massless. The surface has been considered to possess negligible friction. ◀

We conclude this section by making a few remarks on conservative forces.

- (i) Information on time is absent from the above discussions. In the example considered above, we can calculate the compression, but not the time over which the compression occurs. A solution of Newton's Second Law for this system is required for temporal information.
- (ii) Not all forces are conservative. Friction, for example, is a non-conservative force. The principle of conservation of energy will have to be modified in this case. This is illustrated in Example 5.9.
- (iii) The zero of the potential energy is arbitrary. It is set according to convenience. For the spring force we took $V(x) = 0$, at $x = 0$, i.e. the unstretched spring had zero potential energy. For the constant gravitational force mg , we took $V = 0$ on the earth's surface. In a later chapter we shall see that for the force due to the universal law of gravitation, the zero is best defined at an infinite distance from the gravitational source. However, once the zero of the potential energy is fixed in a given discussion, it must be consistently adhered to throughout the discussion. You cannot change horses in midstream !

▶ **Example 5.9** Consider Example 5.8 taking the coefficient of friction, μ , to be 0.5 and calculate the maximum compression of the spring.

Answer In presence of friction, both the spring force and the frictional force act so as to oppose the compression of the spring as shown in Fig. 5.9.

We invoke the work-energy theorem, rather than the conservation of mechanical energy.

The change in kinetic energy is

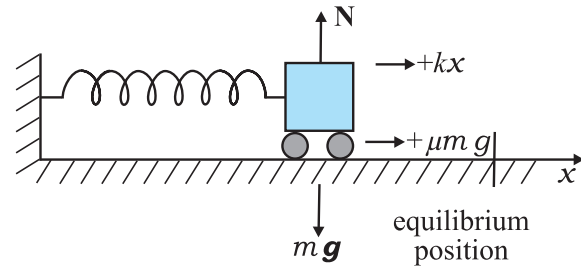

Fig. 5.9 The forces acting on the car.

$$\Delta K = K_f - K_i = 0 - \frac{1}{2} m v^2$$

The work done by the net force is

$$W = -\frac{1}{2} k x_m^2 - \mu m g x_m$$

Equating we have

$$\frac{1}{2} m v^2 = \frac{1}{2} k x_m^2 + \mu m g x_m$$

Now $\mu m g = 0.5 \times 10^3 \times 10 = 5 \times 10^3 \text{ N}$ (taking $g = 10.0 \text{ m s}^{-2}$). After rearranging the above equation we obtain the following quadratic equation in the unknown x_m .

$$k x_m^2 + 2\mu m g x_m - m v^2 = 0$$

$$x_m = \frac{-\mu m g + [\mu^2 m^2 g^2 + m k v^2]^{1/2}}{k}$$

where we take the positive square root since x_m is positive. Putting in numerical values we obtain

$$x_m = 1.35 \text{ m}$$

which, as expected, is less than the result in Example 5.8.

If the two forces on the body consist of a conservative force F_c and a non-conservative force F_{nc} , the conservation of mechanical energy formula will have to be modified. By the WE theorem

$$(F_c + F_{nc}) \Delta x = \Delta K$$

But

$$F_c \Delta x = -\Delta V$$

Hence,

$$\Delta(K + V) = F_{nc} \Delta x$$

$$\Delta E = F_{nc} \Delta x$$

where E is the total mechanical energy. Over the path this assumes the form

$$E_f - E_i = W_{nc}$$

where W_{nc} is the total work done by the non-conservative forces over the path. Note that

unlike the conservative force, W_{nc} depends on the particular path i to f . ◀

5.10 POWER

Often it is interesting to know not only the work done on an object, but also the rate at which this work is done. We say a person is physically fit if he not only climbs four floors of a building but climbs them fast. **Power** is defined as the time rate at which work is done or energy is transferred.

The average power of a force is defined as the ratio of the work, W , to the total time t taken

$$P_{av} = \frac{W}{t}$$

The instantaneous power is defined as the limiting value of the average power as time interval approaches zero,

$$P = \frac{dW}{dt} \quad (5.20)$$

The work dW done by a force \mathbf{F} for a displacement $d\mathbf{r}$ is $dW = \mathbf{F} \cdot d\mathbf{r}$. The instantaneous power can also be expressed as

$$\begin{aligned} P &= \mathbf{F} \cdot \frac{d\mathbf{r}}{dt} \\ &= \mathbf{F} \cdot \mathbf{v} \end{aligned} \quad (5.21)$$

where \mathbf{v} is the instantaneous velocity when the force is \mathbf{F} .

Power, like work and energy, is a scalar quantity. Its dimensions are $[ML^2T^{-3}]$. In the SI, its unit is called a watt (W). The watt is 1 J s^{-1} . The unit of power is named after James Watt, one of the innovators of the steam engine in the eighteenth century.

There is another unit of power, namely the horse-power (hp)

$$1 \text{ hp} = 746 \text{ W}$$

This unit is still used to describe the output of automobiles, motorbikes, etc.

We encounter the unit watt when we buy electrical goods such as bulbs, heaters and refrigerators. A 100 watt bulb which is on for 10 hours uses 1 kilowatt hour (kWh) of energy.

$$\begin{aligned} &100 \text{ (watt)} \times 10 \text{ (hour)} \\ &= 1000 \text{ watt hour} \\ &= 1 \text{ kilowatt hour (kWh)} \\ &= 10^3 \text{ (W)} \times 3600 \text{ (s)} \\ &= 3.6 \times 10^6 \text{ J} \end{aligned}$$

Our electricity bills carry the energy consumption in units of kWh. Note that kWh is a unit of energy and not of power.

▶ **Example 5.10** An elevator can carry a maximum load of 1800 kg (elevator + passengers) is moving up with a constant speed of 2 m s^{-1} . The frictional force opposing the motion is 4000 N. Determine the minimum power delivered by the motor to the elevator in watts as well as in horse power.

Answer The downward force on the elevator is

$$F = mg + F_f = (1800 \times 10) + 4000 = 22000 \text{ N}$$

The motor must supply enough power to balance this force. Hence,

$$P = \mathbf{F} \cdot \mathbf{v} = 22000 \times 2 = 44000 \text{ W} = 59 \text{ hp} \quad \blacktriangleleft$$

5.11 COLLISIONS

In physics we study motion (change in position). At the same time, we try to discover physical quantities, which do not change in a physical process. The laws of momentum and energy conservation are typical examples. In this section we shall apply these laws to a commonly encountered phenomena, namely collisions. Several games such as billiards, marbles or carrom involve collisions. We shall study the collision of two masses in an idealised form.

Consider two masses m_1 and m_2 . The particle m_1 is moving with speed v_{1i} , the subscript ' i ' implying initial. We can consider m_2 to be at rest. No loss of generality is involved in making such a selection. In this situation the mass m_1 collides with the stationary mass m_2 and this is depicted in Fig. 5.10.

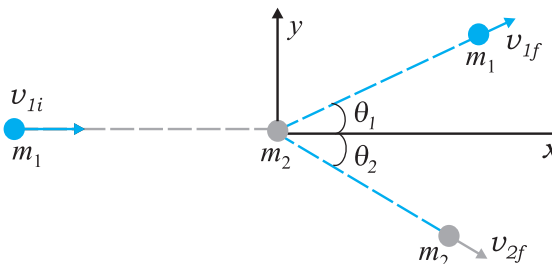

Fig. 5.10 Collision of mass m_1 , with a stationary mass m_2 .

The masses m_1 and m_2 fly-off in different directions. We shall see that there are relationships, which connect the masses, the velocities and the angles.

5.11.1 Elastic and Inelastic Collisions

In all collisions the total linear momentum is conserved; the initial momentum of the system is equal to the final momentum of the system. One can argue this as follows. When two objects collide, the mutual impulsive forces acting over the collision time Δt cause a change in their respective momenta :

$$\begin{aligned}\Delta \mathbf{p}_1 &= \mathbf{F}_{12} \Delta t \\ \Delta \mathbf{p}_2 &= \mathbf{F}_{21} \Delta t\end{aligned}$$

where \mathbf{F}_{12} is the force exerted on the first particle by the second particle. \mathbf{F}_{21} is likewise the force exerted on the second particle by the first particle. Now from Newton's third law, $\mathbf{F}_{12} = -\mathbf{F}_{21}$. This implies

$$\Delta \mathbf{p}_1 + \Delta \mathbf{p}_2 = \mathbf{0}$$

The above conclusion is true even though the forces vary in a complex fashion during the collision time Δt . Since the third law is true at every instant, the total impulse on the first object is equal and opposite to that on the second.

On the other hand, the total kinetic energy of the system is not necessarily conserved. The impact and deformation during collision may generate heat and sound. Part of the initial kinetic energy is transformed into other forms of energy. A useful way to visualise the deformation during collision is in terms of a 'compressed spring'. If the 'spring' connecting the two masses regains its original shape without loss in energy, then the initial kinetic energy is equal to the final kinetic energy but the kinetic energy during the collision time Δt is not constant. Such a collision is called an **elastic collision**. On the other hand the deformation may not be relieved and the two bodies could move together after the collision. A collision in which the two particles move together after the collision is called a **completely inelastic collision**. The intermediate case where the deformation is partly relieved and some of the initial kinetic energy is lost is more common and is appropriately called an **inelastic collision**.

5.11.2 Collisions in One Dimension

Consider first a **completely inelastic collision** in one dimension. Then, in Fig. 5.10,

$$\begin{aligned}\theta_1 &= \theta_2 = 0 \\ m_1 v_{1i} &= (m_1 + m_2) v_f \quad (\text{momentum conservation}) \\ v_f &= \frac{m_1}{m_1 + m_2} v_{1i}\end{aligned}\quad (5.22)$$

The loss in kinetic energy on collision is

$$\begin{aligned}\Delta K &= \frac{1}{2} m_1 v_{1i}^2 - \frac{1}{2} (m_1 + m_2) v_f^2 \\ &= \frac{1}{2} m_1 v_{1i}^2 - \frac{1}{2} \frac{m_1^2}{m_1 + m_2} v_{1i}^2 \quad [\text{using Eq. (5.22)}] \\ &= \frac{1}{2} m_1 v_{1i}^2 \left[1 - \frac{m_1}{m_1 + m_2} \right] \\ &= \frac{1}{2} \frac{m_1 m_2}{m_1 + m_2} v_{1i}^2\end{aligned}$$

which is a positive quantity as expected.

Consider next an elastic collision. Using the above nomenclature with $\theta_1 = \theta_2 = 0$, the momentum and kinetic energy conservation equations are

$$m_1 v_{1i} = m_1 v_{1f} + m_2 v_{2f} \quad (5.23)$$

$$m_1 v_{1i}^2 = m_1 v_{1f}^2 + m_2 v_{2f}^2 \quad (5.24)$$

From Eqs. (5.23) and (5.24) it follows that,

$$m_1 v_{1i} (v_{2f} - v_{1i}) = m_1 v_{1f} (v_{2f} - v_{1f})$$

$$\text{or, } v_{2f} (v_{1i} - v_{1f}) = v_{1i}^2 - v_{1f}^2$$

$$= (v_{1i} - v_{1f})(v_{1i} + v_{1f})$$

$$\text{Hence, } \therefore v_{2f} = v_{1i} + v_{1f} \quad (5.25)$$

Substituting this in Eq. (5.23), we obtain

$$v_{1f} = \frac{(m_1 - m_2)}{m_1 + m_2} v_{1i} \quad (5.26)$$

$$\text{and } v_{2f} = \frac{2m_1 v_{1i}}{m_1 + m_2} \quad (5.27)$$

Thus, the 'unknowns' $\{v_{1f}, v_{2f}\}$ are obtained in terms of the 'knowns' $\{m_1, m_2, v_{1i}\}$. Special cases of our analysis are interesting.

Case I : If the two masses are equal

$$\begin{aligned}v_{1f} &= 0 \\ v_{2f} &= v_{1i}\end{aligned}$$

The first mass comes to rest and pushes off the second mass with its initial speed on collision.

Case II : If one mass dominates, e.g. $m_2 \gg m_1$

$$v_{1f} \simeq -v_{1i} \quad v_{2f} \simeq 0$$

The heavier mass is undisturbed while the lighter mass reverses its velocity.

▶ **Example 5.11 Slowing down of neutrons:** In a nuclear reactor a neutron of high speed (typically 10^7 m s^{-1}) must be slowed to 10^3 m s^{-1} so that it can have a high probability of interacting with isotope $^{235}_{92}\text{U}$ and causing it to fission. Show that a neutron can lose most of its kinetic energy in an elastic collision with a light nuclei like deuterium or carbon which has a mass of only a few times the neutron mass. The material making up the light nuclei, usually heavy water (D_2O) or graphite, is called a moderator.

Answer The initial kinetic energy of the neutron is

$$K_{1i} = \frac{1}{2} m_1 v_{1i}^2$$

while its final kinetic energy from Eq. (5.26)

$$K_{1f} = \frac{1}{2} m_1 v_{1f}^2 = \frac{1}{2} m_1 \left(\frac{m_1 - m_2}{m_1 + m_2} \right)^2 v_{1i}^2$$

The fractional kinetic energy lost is

$$f_1 = \frac{K_{1f}}{K_{1i}} = \left(\frac{m_1 - m_2}{m_1 + m_2} \right)^2$$

while the fractional kinetic energy gained by the moderating nuclei K_{2f}/K_{1i} is

$$\begin{aligned} f_2 &= 1 - f_1 \text{ (elastic collision)} \\ &= \frac{4m_1 m_2}{(m_1 + m_2)^2} \end{aligned}$$

One can also verify this result by substituting from Eq. (5.27).

For deuterium $m_2 = 2m_1$ and we obtain $f_1 = 1/9$ while $f_2 = 8/9$. Almost 90% of the neutron's energy is transferred to deuterium. For carbon $f_1 = 71.6\%$ and $f_2 = 28.4\%$. In practice, however, this number is smaller since head-on collisions are rare. ◀

If the initial velocities and final velocities of both the bodies are along the same straight line, then it is called a one-dimensional collision, or **head-on collision**. In the case of small spherical bodies, this is possible if the direction of travel of body 1 passes through the centre of body 2 which is at rest. In general, the collision is two-

dimensional, where the initial velocities and the final velocities lie in a plane.

5.11.3 Collisions in Two Dimensions

Fig. 5.10 also depicts the collision of a moving mass m_1 with the stationary mass m_2 . Linear momentum is conserved in such a collision. Since momentum is a vector this implies three equations for the three directions $\{x, y, z\}$. Consider the plane determined by the final velocity directions of m_1 and m_2 and choose it to be the x - y plane. The conservation of the z -component of the linear momentum implies that the entire collision is in the x - y plane. The x - and y -component equations are

$$m_1 v_{1i} = m_1 v_{1f} \cos \theta_1 + m_2 v_{2f} \cos \theta_2 \quad (5.28)$$

$$0 = m_1 v_{1f} \sin \theta_1 - m_2 v_{2f} \sin \theta_2 \quad (5.29)$$

One knows $\{m_1, m_2, v_{1i}\}$ in most situations. There are thus four unknowns $\{v_{1f}, v_{2f}, \theta_1 \text{ and } \theta_2\}$, and only two equations. If $\theta_1 = \theta_2 = 0$, we regain Eq. (5.23) for one dimensional collision.

If, further the collision is elastic,

$$\frac{1}{2} m_1 v_{1i}^2 = \frac{1}{2} m_1 v_{1f}^2 + \frac{1}{2} m_2 v_{2f}^2 \quad (5.30)$$

We obtain an additional equation. That still leaves us one equation short. At least one of the four unknowns, say θ_1 , must be made known for the problem to be solvable. For example, θ_1 can be determined by moving a detector in an angular fashion from the x to the y axis. Given $\{m_1, m_2, v_{1i}, \theta_1\}$ we can determine $\{v_{1f}, v_{2f}, \theta_2\}$ from Eqs. (5.28)-(5.30).

▶ **Example 5.12** Consider the collision depicted in Fig. 5.10 to be between two billiard balls with equal masses $m_1 = m_2$. The first ball is called the cue while the second ball is called the target. The billiard player wants to 'sink' the target ball in a corner pocket, which is at an angle $\theta_2 = 37^\circ$. Assume that the collision is elastic and that friction and rotational motion are not important. Obtain θ_1 .

Answer From momentum conservation, since the masses are equal

$$\mathbf{v}_{1i} = \mathbf{v}_{1f} + \mathbf{v}_{2f}$$

$$\begin{aligned} \text{or } v_{1i}^2 &= (\mathbf{v}_{1f} + \mathbf{v}_{2f}) \cdot (\mathbf{v}_{1f} + \mathbf{v}_{2f}) \\ &= v_{1f}^2 + v_{2f}^2 + 2\mathbf{v}_{1f} \cdot \mathbf{v}_{2f} \end{aligned}$$

$$= \{ v_{1f}^2 + v_{2f}^2 + 2v_{1f}v_{2f} \cos (\theta_1 + 37^\circ) \} \quad (5.31)$$

Since the collision is elastic and $m_1 = m_2$ it follows from conservation of kinetic energy that

$$v_{1i}^2 = v_{1f}^2 + v_{2f}^2 \quad (5.32)$$

Comparing Eqs. (5.31) and (5.32), we get

$$\cos (\theta_1 + 37^\circ) = 0$$

$$\text{or} \quad \theta_1 + 37^\circ = 90^\circ$$

Thus, $\theta_1 = 53^\circ$

This proves the following result : when two equal masses undergo a glancing elastic collision with one of them at rest, after the collision, they will move at right angles to each other. ◀

The matter simplifies greatly if we consider spherical masses with smooth surfaces, and assume that collision takes place only when the bodies touch each other. This is what happens in the games of marbles, carrom and billiards.

In our everyday world, collisions take place only when two bodies touch each other. But consider a comet coming from far distances to the sun, or alpha particle coming towards a nucleus and going away in some direction. Here we have to deal with forces involving action at a distance. Such an event is called scattering. The velocities and directions in which the two particles go away depend on their initial velocities as well as the type of interaction between them, their masses, shapes and sizes.

SUMMARY

1. The *work-energy theorem* states that the change in kinetic energy of a body is the work done by the net force on the body.
2. A force is *conservative* if (i) work done by it on an object is path independent and depends only on the end points $\{x_i, x_f\}$, or (ii) the work done by the force is zero for an arbitrary closed path taken by the object such that it returns to its initial position.
3. For a conservative force in one dimension, we may define a *potential energy* function $V(x)$ such that

$$F(x) = - \frac{dV(x)}{dx}$$

$$\text{or} \quad V_i - V_f = \int_{x_i}^{x_f} F(x) dx$$

4. The principle of conservation of mechanical energy states that the total mechanical energy of a body remains constant if the only forces that act on the body are conservative.
5. The *gravitational potential energy* of a particle of mass m at a height x about the earth's surface is

$$V(x) = m g x$$

where the variation of g with height is ignored.

5. The elastic potential energy of a spring of force constant k and extension x is

$$V(x) = \frac{1}{2} k x^2$$

7. The scalar or dot product of two vectors \mathbf{A} and \mathbf{B} is written as $\mathbf{A} \cdot \mathbf{B}$ and is a scalar quantity given by $\mathbf{A} \cdot \mathbf{B} = AB \cos \theta$, where θ is the angle between \mathbf{A} and \mathbf{B} . It can be positive, negative or zero depending upon the value of θ . The scalar product of two vectors can be interpreted as the product of magnitude of one vector and component of the other vector along the first vector. For unit vectors :

$$\hat{\mathbf{i}} \cdot \hat{\mathbf{i}} = \hat{\mathbf{j}} \cdot \hat{\mathbf{j}} = \hat{\mathbf{k}} \cdot \hat{\mathbf{k}} = 1 \quad \text{and} \quad \hat{\mathbf{i}} \cdot \hat{\mathbf{j}} = \hat{\mathbf{j}} \cdot \hat{\mathbf{k}} = \hat{\mathbf{k}} \cdot \hat{\mathbf{i}} = 0$$

Scalar products obey the commutative and the distributive laws.

| Physical Quantity | Symbol | Dimensions | Units | Remarks |
|-------------------|--------|----------------|-------------|--|
| Work | W | $[ML^2T^{-2}]$ | J | $W = \mathbf{F} \cdot \mathbf{d}$ |
| Kinetic energy | K | $[ML^2T^{-2}]$ | J | $K = \frac{1}{2}mv^2$ |
| Potential energy | $V(x)$ | $[ML^2T^{-2}]$ | J | $F(x) = -\frac{dV(x)}{dx}$ |
| Mechanical energy | E | $[ML^2T^{-2}]$ | J | $E = K + V$ |
| Spring constant | k | $[MT^{-2}]$ | $N\ m^{-1}$ | $F = -kx$ $V(x) = \frac{1}{2}kx^2$ |
| Power | P | $[ML^2T^{-3}]$ | W | $P = \mathbf{F} \cdot \mathbf{v}$ $P = \frac{dW}{dt}$ |

POINTS TO PONDER

- The phrase 'calculate the work done' is incomplete. We should refer (or imply clearly by context) to the work done by a specific force or a group of forces on a given body over a certain displacement.
- Work done is a scalar quantity. It can be positive or negative unlike mass and kinetic energy which are positive scalar quantities. The work done by the friction or viscous force on a moving body is negative.
- For two bodies, the sum of the mutual forces exerted between them is zero from Newton's Third Law,

$$\mathbf{F}_{12} + \mathbf{F}_{21} = 0$$

But the sum of the work done by the two forces need not *always cancel*, i.e.

$$W_{12} + W_{21} \neq 0$$

However, it *may sometimes be true*.

- The work done by a force can be calculated sometimes even if the exact nature of the force is not known. This is clear from Example 5.2 where the WE theorem is used in such a situation.
- The WE theorem is not independent of Newton's Second Law. The WE theorem may be viewed as a scalar form of the Second Law. The principle of conservation of mechanical energy may be viewed as a consequence of the WE theorem for conservative forces.
- The WE theorem holds in all inertial frames. It can also be extended to non-inertial frames provided we include the pseudoforces in the calculation of the net force acting on the body under consideration.
- The potential energy of a body subjected to a conservative force is always undetermined upto a constant. For example, the point where the potential energy is zero is a matter of choice. For the gravitational potential energy mgh , the zero of the potential energy is chosen to be the ground. For the spring potential energy $kx^2/2$, the zero of the potential energy is the equilibrium position of the oscillating mass.
- Every force encountered in mechanics does not have an associated potential energy. For example, work done by friction over a closed path is not zero and no potential energy can be associated with friction.
- During a collision : (a) the total linear momentum is conserved at each instant of the collision ; (b) the kinetic energy conservation (even if the collision is elastic) applies after the collision is over and does not hold at every instant of the collision. In fact the two colliding objects are deformed and may be momentarily at rest with respect to each other.

EXERCISES

- 5.1** The sign of work done by a force on a body is important to understand. State carefully if the following quantities are positive or negative:
- work done by a man in lifting a bucket out of a well by means of a rope tied to the bucket.
 - work done by gravitational force in the above case,
 - work done by friction on a body sliding down an inclined plane,
 - work done by an applied force on a body moving on a rough horizontal plane with uniform velocity,
 - work done by the resistive force of air on a vibrating pendulum in bringing it to rest.
- 5.2** A body of mass 2 kg initially at rest moves under the action of an applied horizontal force of 7 N on a table with coefficient of kinetic friction = 0.1. Compute the
- work done by the applied force in 10 s,
 - work done by friction in 10 s,
 - work done by the net force on the body in 10 s,
 - change in kinetic energy of the body in 10 s,
- and interpret your results.
- 5.3** Given in Fig. 5.11 are examples of some potential energy functions in one dimension. The total energy of the particle is indicated by a cross on the ordinate axis. In each case, specify the regions, if any, in which the particle cannot be found for the given energy. Also, indicate the minimum total energy the particle must have in each case. Think of simple physical contexts for which these potential energy shapes are relevant.

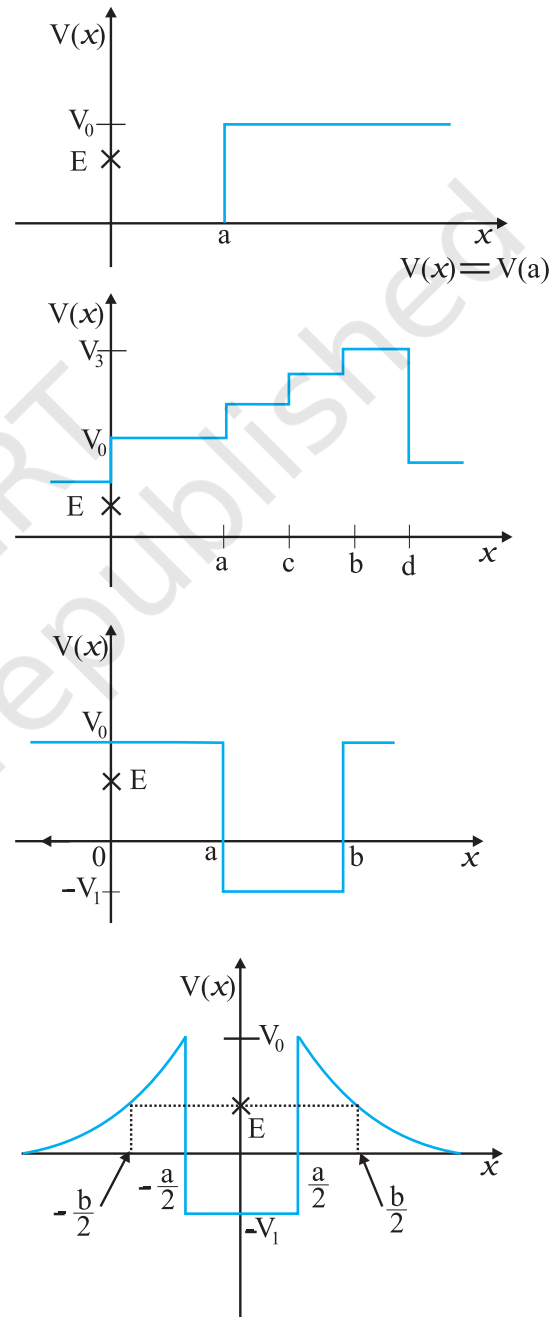

Fig. 5.11

- 5.4** The potential energy function for a particle executing linear simple harmonic motion is given by $V(x) = kx^2/2$, where k is the force constant of the oscillator. For $k = 0.5 \text{ N m}^{-1}$, the graph of $V(x)$ versus x is shown in Fig. 5.12. Show that a particle of total energy 1 J moving under this potential must 'turn back' when it reaches $x = \pm 2 \text{ m}$.

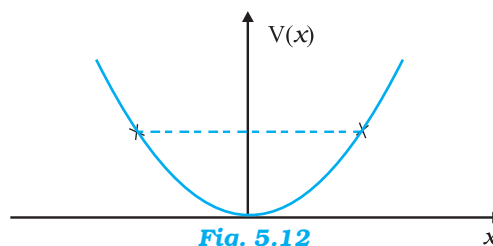

Fig. 5.12

- 5.5** Answer the following :

- (a) The casing of a rocket in flight burns up due to friction. At whose expense is the heat energy required for burning obtained? The rocket or the atmosphere?
- (b) Comets move around the sun in highly elliptical orbits. The gravitational force on the comet due to the sun is not normal to the comet's velocity in general. Yet the work done by the gravitational force over every complete orbit of the comet is zero. Why ?
- (c) An artificial satellite orbiting the earth in very thin atmosphere loses its energy gradually due to dissipation against atmospheric resistance, however small. Why then does its speed increase progressively as it comes closer and closer to the earth ?
- (d) In Fig. 5.13(i) the man walks 2 m carrying a mass of 15 kg on his hands. In Fig. 5.13(ii), he walks the same distance pulling the rope behind him. The rope goes over a pulley, and a mass of 15 kg hangs at its other end. In which case is the work done greater ?

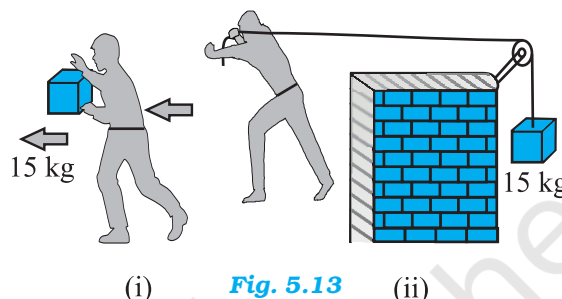

Fig. 5.13

- 5.6** Underline the correct alternative :

- (a) When a conservative force does positive work on a body, the potential energy of the body increases/decreases/remains unaltered.
- (b) Work done by a body against friction always results in a loss of its kinetic/potential energy.
- (c) The rate of change of total momentum of a many-particle system is proportional to the external force/sum of the internal forces on the system.
- (d) In an inelastic collision of two bodies, the quantities which do not change after the collision are the total kinetic energy/total linear momentum/total energy of the system of two bodies.

- 5.7** State if each of the following statements is true or false. Give reasons for your answer.

- (a) In an elastic collision of two bodies, the momentum and energy of each body is conserved.
- (b) Total energy of a system is always conserved, no matter what internal and external forces on the body are present.
- (c) Work done in the motion of a body over a closed loop is zero for every force in nature.
- (d) In an inelastic collision, the final kinetic energy is always less than the initial kinetic energy of the system.

- 5.8** Answer carefully, with reasons :

- (a) In an elastic collision of two billiard balls, is the total kinetic energy conserved during the short time of collision of the balls (i.e. when they are in contact) ?
- (b) Is the total linear momentum conserved during the short time of an elastic collision of two balls ?

- (c) What are the answers to (a) and (b) for an inelastic collision ?
 (d) If the potential energy of two billiard balls depends only on the separation distance between their centres, is the collision elastic or inelastic ? (Note, we are talking here of potential energy corresponding to the force during collision, not gravitational potential energy).

- 5.9** A body is initially at rest. It undergoes one-dimensional motion with constant acceleration. The power delivered to it at time t is proportional to
 (i) $t^{1/2}$ (ii) t (iii) $t^{3/2}$ (iv) t^2
- 5.10** A body is moving unidirectionally under the influence of a source of constant power. Its displacement in time t is proportional to
 (i) $t^{1/2}$ (ii) t (iii) $t^{3/2}$ (iv) t^2
- 5.11** A body constrained to move along the z -axis of a coordinate system is subject to a constant force \mathbf{F} given by

$$\mathbf{F} = -\hat{i} + 2\hat{j} + 3\hat{k} \text{ N}$$

where $\hat{i}, \hat{j}, \hat{k}$ are unit vectors along the x -, y - and z -axis of the system respectively. What is the work done by this force in moving the body a distance of 4 m along the z -axis ?

- 5.12** An electron and a proton are detected in a cosmic ray experiment, the first with kinetic energy 10 keV, and the second with 100 keV. Which is faster, the electron or the proton ? Obtain the ratio of their speeds. (electron mass = 9.11×10^{-31} kg, proton mass = 1.67×10^{-27} kg, $1 \text{ eV} = 1.60 \times 10^{-19} \text{ J}$).
- 5.13** A rain drop of radius 2 mm falls from a height of 500 m above the ground. It falls with decreasing acceleration (due to viscous resistance of the air) until at half its original height, it attains its maximum (terminal) speed, and moves with uniform speed thereafter. What is the work done by the gravitational force on the drop in the first and second half of its journey ? What is the work done by the resistive force in the entire journey if its speed on reaching the ground is 10 m s^{-1} ?
- 5.14** A molecule in a gas container hits a horizontal wall with speed 200 m s^{-1} and angle 30° with the normal, and rebounds with the same speed. Is momentum conserved in the collision ? Is the collision elastic or inelastic ?
- 5.15** A pump on the ground floor of a building can pump up water to fill a tank of volume 30 m^3 in 15 min. If the tank is 40 m above the ground, and the efficiency of the pump is 30%, how much electric power is consumed by the pump ?
- 5.16** Two identical ball bearings in contact with each other and resting on a frictionless table are hit head-on by another ball bearing of the same mass moving initially with a speed V . If the collision is elastic, which of the following (Fig. 5.14) is a possible result after collision ?

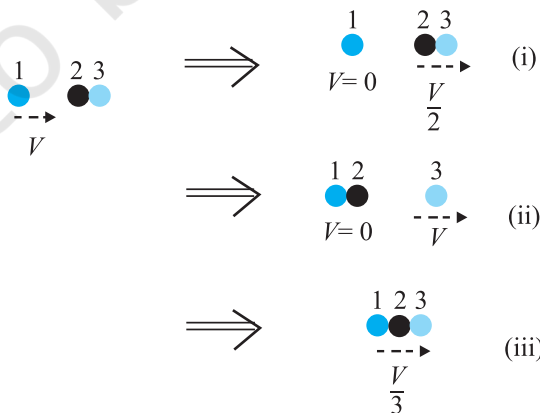

Fig. 5.14

5.17 The bob A of a pendulum released from 30° to the vertical hits another bob B of the same mass at rest on a table as shown in Fig. 5.15. How high does the bob A rise after the collision? Neglect the size of the bobs and assume the collision to be elastic.

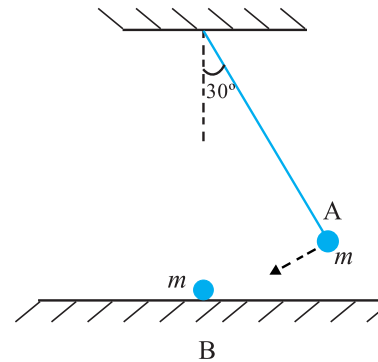

Fig. 5.15

5.18 The bob of a pendulum is released from a horizontal position. If the length of the pendulum is 1.5 m, what is the speed with which the bob arrives at the lowermost point, given that it dissipated 5% of its initial energy against air resistance?

5.19 A trolley of mass 300 kg carrying a sandbag of 25 kg is moving uniformly with a speed of 27 km/h on a frictionless track. After a while, sand starts leaking out of a hole on the floor of the trolley at the rate of 0.05 kg s^{-1} . What is the speed of the trolley after the entire sand bag is empty?

5.20 A body of mass 0.5 kg travels in a straight line with velocity $v = ax^{3/2}$ where $a = 5 \text{ m}^{-1/2} \text{ s}^{-1}$. What is the work done by the net force during its displacement from $x = 0$ to $x = 2 \text{ m}$?

5.21 The blades of a windmill sweep out a circle of area A . (a) If the wind flows at a velocity v perpendicular to the circle, what is the mass of the air passing through it in time t ? (b) What is the kinetic energy of the air? (c) Assume that the windmill converts 25% of the wind's energy into electrical energy, and that $A = 30 \text{ m}^2$, $v = 36 \text{ km/h}$ and the density of air is 1.2 kg m^{-3} . What is the electrical power produced?

5.22 A person trying to lose weight (dieter) lifts a 10 kg mass, one thousand times, to a height of 0.5 m each time. Assume that the potential energy lost each time she lowers the mass is dissipated. (a) How much work does she do against the gravitational force? (b) Fat supplies $3.8 \times 10^7 \text{ J}$ of energy per kilogram which is converted to mechanical energy with a 20% efficiency rate. How much fat will the dieter use up?

5.23 A family uses 8 kW of power. (a) Direct solar energy is incident on the horizontal surface at an average rate of 200 W per square meter. If 20% of this energy can be converted to useful electrical energy, how large an area is needed to supply 8 kW? (b) Compare this area to that of the roof of a typical house.



SYSTEMS OF PARTICLES AND ROTATIONAL MOTION

- 6.1 Introduction
- 6.2 Centre of mass
- 6.3 Motion of centre of mass
- 6.4 Linear momentum of a system of particles
- 6.5 Vector product of two vectors
- 6.6 Angular velocity and its relation with linear velocity
- 6.7 Torque and angular momentum
- 6.8 Equilibrium of a rigid body
- 6.9 Moment of inertia
- 6.10 Kinematics of rotational motion about a fixed axis
- 6.11 Dynamics of rotational motion about a fixed axis
- 6.12 Angular momentum in case of rotation about a fixed axis
- Summary
- Points to Ponder
- Exercises

6.1 INTRODUCTION

In the earlier chapters we primarily considered the motion of a single particle. (A particle is ideally represented as a point mass having no size.) We applied the results of our study even to the motion of bodies of finite size, assuming that motion of such bodies can be described in terms of the motion of a particle.

Any real body which we encounter in daily life has a finite size. In dealing with the motion of extended bodies (bodies of finite size) often the idealised model of a particle is inadequate. In this chapter we shall try to go beyond this inadequacy. We shall attempt to build an understanding of the motion of extended bodies. An extended body, in the first place, is a system of particles. We shall begin with the consideration of motion of the system as a whole. The centre of mass of a system of particles will be a key concept here. We shall discuss the motion of the centre of mass of a system of particles and usefulness of this concept in understanding the motion of extended bodies.

A large class of problems with extended bodies can be solved by considering them to be rigid bodies. **Ideally a rigid body is a body with a perfectly definite and unchanging shape. The distances between all pairs of particles of such a body do not change.** It is evident from this definition of a rigid body that no real body is truly rigid, since real bodies deform under the influence of forces. But in many situations the deformations are negligible. In a number of situations involving bodies such as wheels, tops, steel beams, molecules and planets on the other hand, we can ignore that they warp (twist out of shape), bend or vibrate and treat them as rigid.

6.1.1 What kind of motion can a rigid body have?

Let us try to explore this question by taking some examples of the motion of rigid bodies. Let us begin with a rectangular

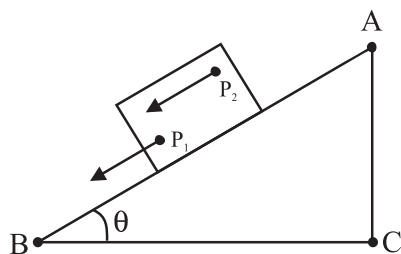

Fig 6.1 Translational (sliding) motion of a block down an inclined plane.

(Any point like P_1 or P_2 of the block moves with the same velocity at any instant of time.)

block sliding down an inclined plane without any sidewise movement. The block is taken as a rigid body. Its motion down the plane is such that all the particles of the body are moving together, i.e. they have the same velocity at any instant of time. The rigid body here is in pure translational motion (Fig. 6.1).

In pure translational motion at any instant of time, all particles of the body have the same velocity.

Consider now the rolling motion of a solid metallic or wooden cylinder down the same inclined plane (Fig. 6.2). The rigid body in this problem, namely the cylinder, shifts from the top to the bottom of the inclined plane, and thus, seems to have translational motion. But as Fig. 6.2 shows, all its particles are not moving with the same velocity at any instant. The body, therefore, is not in pure translational motion. Its motion is translational plus ‘something else.’

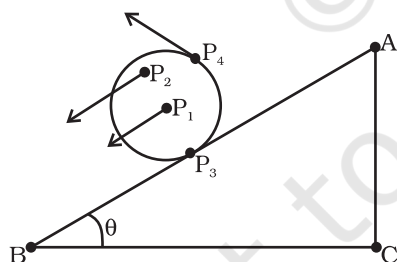

Fig. 6.2 Rolling motion of a cylinder. It is not pure translational motion. Points P_1 , P_2 , P_3 and P_4 have different velocities (shown by arrows) at any instant of time. In fact, the velocity of the point of contact P_3 is zero at any instant, if the cylinder rolls without slipping.

In order to understand what this ‘something else’ is, let us take a rigid body so constrained that it cannot have translational motion. The

most common way to constrain a rigid body so that it does not have translational motion is to fix it along a straight line. The only possible motion of such a rigid body is **rotation**. The line or fixed axis about which the body is rotating is its **axis of rotation**. If you look around, you will come across many examples of rotation about an axis, a ceiling fan, a potter’s wheel, a giant wheel in a fair, a merry-go-round and so on (Fig 6.3(a) and (b)).

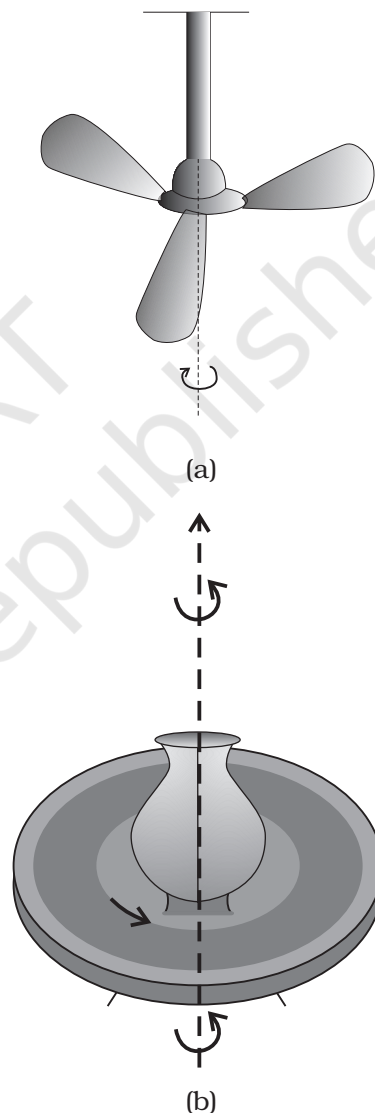

Fig. 6.3 Rotation about a fixed axis
(a) A ceiling fan
(b) A potter’s wheel.

Let us try to understand what rotation is, what characterises rotation. You may notice that **in rotation of a rigid body about a fixed axis,**

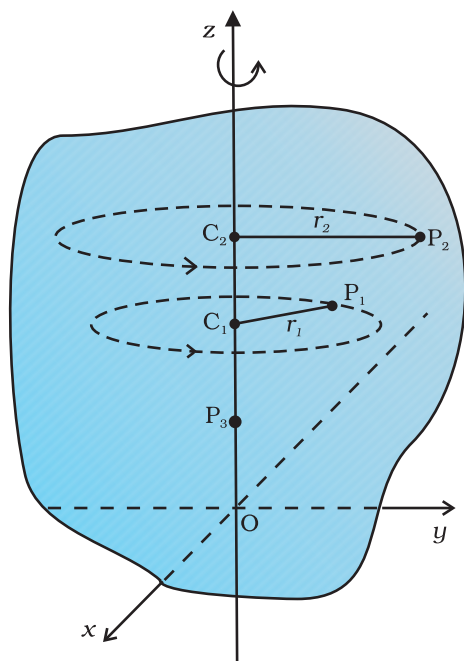

Fig. 6.4 A rigid body rotation about the z-axis (Each point of the body such as P_1 or P_2 describes a circle with its centre (C_1 or C_2) on the axis of rotation. The radius of the circle (r_1 or r_2) is the perpendicular distance of the point (P_1 or P_2) from the axis. A point on the axis like P_3 remains stationary).

every particle of the body moves in a circle, which lies in a plane perpendicular to the axis and has its centre on the axis. Fig. 6.4 shows the rotational motion of a rigid body about a fixed axis (the z-axis of the frame of reference). Let P_1 be a particle of the rigid body, arbitrarily chosen and at a distance r_1 from fixed axis. The particle P_1 describes a circle of radius r_1 with its centre C_1 on the fixed axis. The circle lies in a plane perpendicular to the axis. The figure also shows another particle P_2 of the rigid body, P_2 is at a distance r_2 from the fixed axis. The particle P_2 moves in a circle of radius r_2 and with centre C_2 on the axis. This circle, too, lies in a plane perpendicular to the axis. Note that the circles described by P_1 and P_2 may lie in different planes; both these planes, however, are perpendicular to the fixed axis. For any particle on the axis like P_3 , $r = 0$. Any such particle remains stationary while the body rotates. This is expected since the axis of rotation is fixed.

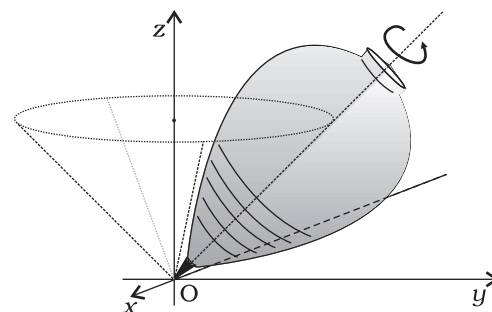

Fig. 6.5 (a) A spinning top (The point of contact of the top with the ground, its tip O , is fixed.)

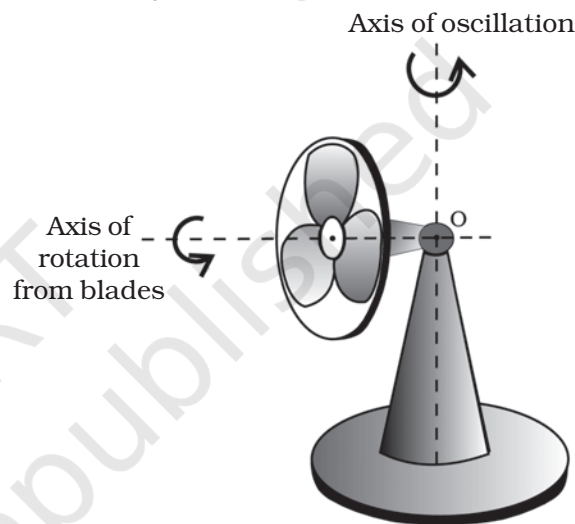

Fig. 6.5 (b) An oscillating table fan with rotating blades. The pivot of the fan, point O , is fixed. The blades of the fan are under rotational motion, whereas, the axis of rotation of the fan blades is oscillating.

In some examples of rotation, however, the axis may not be fixed. A prominent example of this kind of rotation is a top spinning in place [Fig. 6.5(a)]. (We assume that the top does not slip from place to place and so does not have translational motion.) We know from experience that the axis of such a spinning top moves around the vertical through its point of contact with the ground, sweeping out a cone as shown in Fig. 6.5(a). (This movement of the axis of the top around the vertical is termed **precession**.) Note, the **point of contact of the top with ground is fixed**. The axis of rotation of the top at any instant passes through the point of contact. Another simple example of this kind of rotation is the oscillating table fan or a pedestal fan [Fig.6.5(b)]. You may have observed that the

axis of rotation of such a fan has an oscillating (sidewise) movement in a horizontal plane about the vertical through the point at which the axis is pivoted (point O in Fig. 6.5(b)).

While the fan rotates and its axis moves sidewise, this point is fixed. Thus, in more general cases of rotation, such as the rotation of a top or a pedestal fan, **one point and not one line**, of the rigid body is fixed. In this case the axis is not fixed, though it always passes through the fixed point. In our study, however, we mostly deal with the simpler and special case of rotation in which one line (i.e. the axis) is fixed.

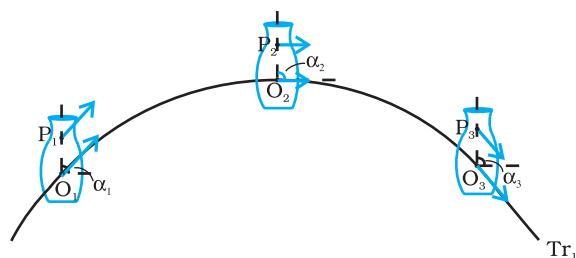

Fig. 6.6(a) Motion of a rigid body which is pure translation.

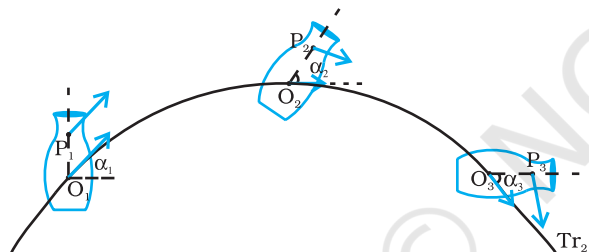

Fig. 6.6(b) Motion of a rigid body which is a combination of translation and rotation.

Fig 6.6 (a) and 6.6 (b) illustrate different motions of the same body. Note P is an arbitrary point of the body; O is the centre of mass of the body, which is defined in the next section. Suffice to say here that the trajectories of O are the translational trajectories Tr_1 and Tr_2 of the body. The positions O and P at three different instants of time are shown by $O_1, O_2,$ and $O_3,$ and P_1, P_2 and $P_3,$ respectively, in both Figs. 6.6 (a) and (b). As seen from Fig. 6.6(a), at any instant the velocities of any particles like O and P of the body are the same in pure translation. Notice, in this case the orientation of OP, i.e. the angle OP makes with a fixed direction, say the horizontal, remains the same, i.e. $\alpha_1 = \alpha_2 = \alpha_3$. Fig. 6.6 (b) illustrates a case of combination of translation and rotation. In this case, at any instants the velocities of O and P differ. Also, α_1, α_2 and α_3 may all be different.

Thus, for us rotation will be about a fixed axis only unless stated otherwise.

The rolling motion of a cylinder down an inclined plane is a combination of rotation about a fixed axis and translation. Thus, the ‘something else’ in the case of rolling motion which we referred to earlier is rotational motion. You will find Fig. 6.6(a) and (b) instructive from this point of view. Both these figures show motion of the same body along identical translational trajectory. In one case, Fig. 6.6(a), the motion is a pure translation; in the other case [Fig. 6.6(b)] it is a combination of translation and rotation. (You may try to reproduce the two types of motion shown, using a rigid object like a heavy book.)

We now recapitulate the most important observations of the present section: **The motion of a rigid body which is not pivoted or fixed in some way is either a pure translation or a combination of translation and rotation. The motion of a rigid body which is pivoted or fixed in some way is rotation.** The rotation may be about an axis that is fixed (e.g. a ceiling fan) or moving (e.g. an oscillating table fan [Fig.6.5(b)]). We shall, in the present chapter, consider rotational motion about a fixed axis only.

6.2 CENTRE OF MASS

We shall first see what the centre of mass of a system of particles is and then discuss its significance. For simplicity we shall start with a two particle system. We shall take the line joining the two particles to be the x- axis.

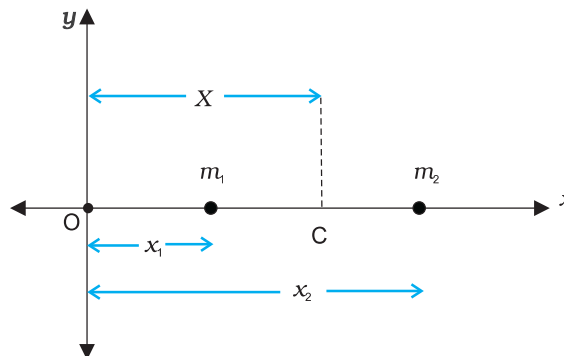

Fig. 6.7

Let the distances of the two particles be x_1 and x_2 respectively from some origin O. Let m_1 and m_2 be respectively the masses of the two

particles. The centre of mass of the system is that point C which is at a distance X from O, where X is given by

$$X = \frac{m_1x_1 + m_2x_2}{m_1 + m_2} \quad (6.1)$$

In Eq. (6.1), X can be regarded as the mass-weighted mean of x_1 and x_2 . If the two particles have the same mass $m_1 = m_2 = m$ then

$$X = \frac{mx_1 + mx_2}{2m} = \frac{x_1 + x_2}{2}$$

Thus, for two particles of equal mass the centre of mass lies exactly midway between them.

If we have n particles of masses m_1, m_2, \dots, m_n respectively, along a straight line taken as the x -axis, then by definition the position of the centre of the mass of the system of particles is given by.

$$X = \frac{m_1x_1 + m_2x_2 + \dots + m_nx_n}{m_1 + m_2 + \dots + m_n} = \frac{\sum_{i=1}^n m_i x_i}{\sum_{i=1}^n m_i} = \frac{\sum m_i x_i}{\sum m_i} \quad (6.2)$$

where x_1, x_2, \dots, x_n are the distances of the particles from the origin; X is also measured from the same origin. The symbol \sum (the Greek letter sigma) denotes summation, in this case over n particles. The sum

$$\sum m_i = M$$

is the total mass of the system.

Suppose that we have three particles, not lying in a straight line. We may define x - and y -axes in the plane in which the particles lie and represent the positions of the three particles by coordinates (x_1, y_1) , (x_2, y_2) and (x_3, y_3) respectively. Let the masses of the three particles be m_1, m_2 and m_3 respectively. The centre of mass C of the system of the three particles is defined and located by the coordinates (X, Y) given by

$$X = \frac{m_1x_1 + m_2x_2 + m_3x_3}{m_1 + m_2 + m_3} \quad (6.3a)$$

$$Y = \frac{m_1y_1 + m_2y_2 + m_3y_3}{m_1 + m_2 + m_3} \quad (6.3b)$$

For the particles of equal mass $m = m_1 = m_2 = m_3$,

$$X = \frac{m(x_1 + x_2 + x_3)}{3m} = \frac{x_1 + x_2 + x_3}{3}$$

$$Y = \frac{m(y_1 + y_2 + y_3)}{3m} = \frac{y_1 + y_2 + y_3}{3}$$

Thus, for three particles of equal mass, the centre of mass coincides with the centroid of the triangle formed by the particles.

Results of Eqs. (6.3a) and (6.3b) are generalised easily to a system of n particles, not necessarily lying in a plane, but distributed in space. The centre of mass of such a system is at (X, Y, Z) , where

$$X = \frac{\sum m_i x_i}{M} \quad (6.4a)$$

$$Y = \frac{\sum m_i y_i}{M} \quad (6.4b)$$

$$\text{and } Z = \frac{\sum m_i z_i}{M} \quad (6.4c)$$

Here $M = \sum m_i$ is the total mass of the system. The index i runs from 1 to n ; m_i is the mass of the i^{th} particle and the position of the i^{th} particle is given by (x_i, y_i, z_i) .

Eqs. (6.4a), (6.4b) and (6.4c) can be combined into one equation using the notation of position vectors. Let \mathbf{r}_i be the position vector of the i^{th} particle and \mathbf{R} be the position vector of the centre of mass:

$$\mathbf{r}_i = x_i \hat{\mathbf{i}} + y_i \hat{\mathbf{j}} + z_i \hat{\mathbf{k}}$$

$$\text{and } \mathbf{R} = X \hat{\mathbf{i}} + Y \hat{\mathbf{j}} + Z \hat{\mathbf{k}}$$

$$\mathbf{R} = \frac{\sum m_i \mathbf{r}_i}{M} \quad (6.4d)$$

Then

The sum on the right hand side is a vector sum.

Note the economy of expressions we achieve by use of vectors. If the origin of the frame of reference (the coordinate system) is chosen to be the centre of mass then $\sum m_i \mathbf{r}_i = 0$ for the given system of particles.

A rigid body, such as a metre stick or a flywheel, is a system of closely packed particles; Eqs. (6.4a), (6.4b), (6.4c) and (6.4d) are therefore, applicable to a rigid body. The number of particles (atoms or molecules) in such a body is so large that it is impossible to carry out the summations over individual particles in these equations. Since the spacing of the particles is

small, we can treat the body as a continuous distribution of mass. We subdivide the body into n small elements of mass; $\Delta m_1, \Delta m_2, \dots, \Delta m_n$; the i^{th} element Δm_i is taken to be located about the point (x_i, y_i, z_i) . The coordinates of the centre of mass are then approximately given by

$$X = \frac{\sum (\Delta m_i) x_i}{\sum \Delta m_i}, Y = \frac{\sum (\Delta m_i) y_i}{\sum \Delta m_i}, Z = \frac{\sum (\Delta m_i) z_i}{\sum \Delta m_i}$$

As we make n bigger and bigger and each Δm_i smaller and smaller, these expressions become exact. In that case, we denote the sums over i by integrals. Thus,

$$\sum \Delta m_i \rightarrow \int dm = M,$$

$$\sum (\Delta m_i) x_i \rightarrow \int x dm,$$

$$\sum (\Delta m_i) y_i \rightarrow \int y dm,$$

and $\sum (\Delta m_i) z_i \rightarrow \int z dm$

Here M is the total mass of the body. The coordinates of the centre of mass now are

$$X = \frac{1}{M} \int x dm, Y = \frac{1}{M} \int y dm \text{ and } Z = \frac{1}{M} \int z dm \quad (6.5a)$$

The vector expression equivalent to these three scalar expressions is

$$\mathbf{R} = \frac{1}{M} \int \mathbf{r} dm \quad (6.5b)$$

If we choose, the centre of mass as the origin of our coordinate system,

$$\mathbf{R} = \mathbf{0}$$

$$\text{i.e., } \int \mathbf{r} dm = \mathbf{0}$$

$$\text{or } \int x dm = \int y dm = \int z dm = 0 \quad (6.6)$$

Often we have to calculate the centre of mass of homogeneous bodies of regular shapes like rings, discs, spheres, rods etc. (By a homogeneous body we mean a body with uniformly distributed mass.) By using symmetry consideration, we can easily show that the centres of mass of these bodies lie at their geometric centres.

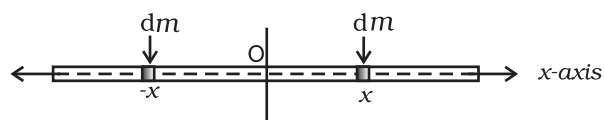

Fig. 6.8 Determining the CM of a thin rod.

Let us consider a thin rod, whose width and breadth (in case the cross section of the rod is rectangular) or radius (in case the cross section of the rod is cylindrical) is much smaller than its length. Taking the origin to be at the geometric centre of the rod and x-axis to be along the length of the rod, we can say that on account of reflection symmetry, for every element dm of the rod at x , there is an element of the same mass dm located at $-x$ (Fig. 6.8).

The net contribution of every such pair to the integral and hence the integral $\int x dm$ itself is zero. From Eq. (6.6), the point for which the integral itself is zero, is the centre of mass. Thus, the centre of mass of a homogeneous thin rod coincides with its geometric centre. This can be understood on the basis of reflection symmetry.

The same symmetry argument will apply to homogeneous rings, discs, spheres, or even thick rods of circular or rectangular cross section. For all such bodies you will realise that for every element dm at a point (x, y, z) one can always take an element of the same mass at the point $(-x, -y, -z)$. (In other words, the origin is a point of reflection symmetry for these bodies.) As a result, the integrals in Eq. (6.5 a) all are zero. This means that for all the above bodies, their centre of mass coincides with their geometric centre.

► **Example 6.1** Find the centre of mass of three particles at the vertices of an equilateral triangle. The masses of the particles are 100g, 150g, and 200g respectively. Each side of the equilateral triangle is 0.5m long.

Answer

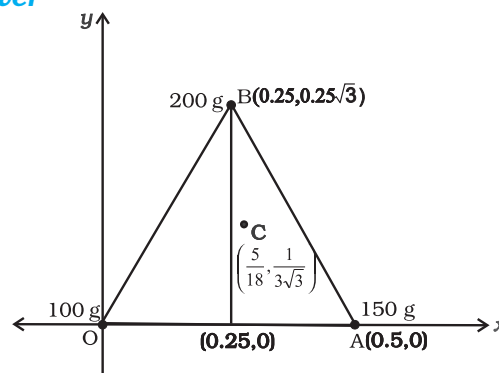



Fig. 6.9

With the x - and y -axes chosen as shown in Fig. 6.9, the coordinates of points O, A and B forming the equilateral triangle are respectively $(0,0)$, $(0.5,0)$, $(0.25,0.25\sqrt{3})$. Let the masses 100 g, 150g and 200g be located at O, A and B be respectively. Then,

$$\begin{aligned} X &= \frac{m_1x_1 + m_2x_2 + m_3x_3}{m_1 + m_2 + m_3} \\ &= \frac{100(0) + 150(0.5) + 200(0.25)}{(100 + 150 + 200)} \text{ g m} \\ &= \frac{75 + 50}{450} \text{ m} = \frac{125}{450} \text{ m} = \frac{5}{18} \text{ m} \\ Y &= \frac{100(0) + 150(0) + 200(0.25\sqrt{3})}{450} \text{ g m} \\ &= \frac{50\sqrt{3}}{450} \text{ m} = \frac{\sqrt{3}}{9} \text{ m} = \frac{1}{3\sqrt{3}} \text{ m} \end{aligned}$$

The centre of mass C is shown in the figure. Note that it is not the geometric centre of the triangle OAB. Why? 

▶ Example 6.2 Find the centre of mass of a triangular lamina.

Answer The lamina ($\triangle LMN$) may be subdivided into narrow strips each parallel to the base (MN) as shown in Fig. 6.10

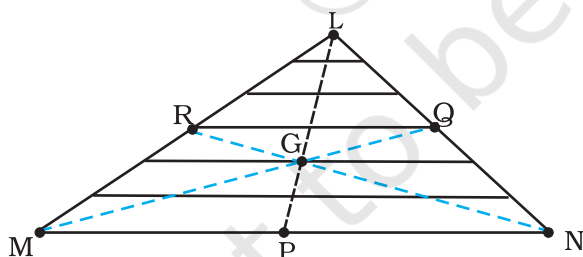

Fig. 6.10

By symmetry each strip has its centre of mass at its midpoint. If we join the midpoint of all the strips we get the median LP. The centre of mass of the triangle as a whole therefore, has to lie on the median LP. Similarly, we can argue that it lies on the median MQ and NR. This means the centre of mass lies on the point of

concurrency of the medians, i.e. on the centroid G of the triangle. 

▶ Example 6.3 Find the centre of mass of a uniform L-shaped lamina (a thin flat plate) with dimensions as shown. The mass of the lamina is 3 kg.

Answer Choosing the X and Y axes as shown in Fig. 6.11 we have the coordinates of the vertices of the L-shaped lamina as given in the figure. We can think of the L-shape to consist of 3 squares each of length 1m. The mass of each square is 1kg, since the lamina is uniform. The centres of mass C_1 , C_2 and C_3 of the squares are, by symmetry, their geometric centres and have coordinates $(1/2, 1/2)$, $(3/2, 1/2)$, $(1/2, 3/2)$ respectively. We take the masses of the squares to be concentrated at these points. The centre of mass of the whole L shape (X, Y) is the centre of mass of these mass points.

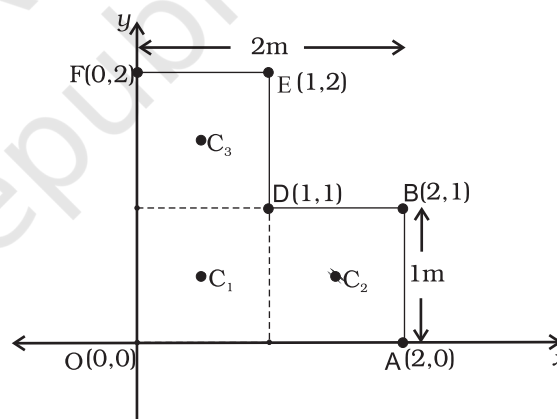

Fig. 6.11

Hence

$$X = \frac{[1(1/2) + 1(3/2) + 1(1/2)] \text{ kg m}}{(1 + 1 + 1) \text{ kg}} = \frac{5}{6} \text{ m}$$

$$Y = \frac{[1(1/2) + 1(1/2) + 1(3/2)] \text{ kg m}}{(1 + 1 + 1) \text{ kg}} = \frac{5}{6} \text{ m}$$

The centre of mass of the L-shape lies on the line OD. We could have guessed this without calculations. Can you tell why? Suppose, the three squares that make up the L shaped lamina

of Fig. 6.11 had different masses. How will you then determine the centre of mass of the lamina?

6.3 MOTION OF CENTRE OF MASS

Equipped with the definition of the centre of mass, we are now in a position to discuss its physical importance for a system of n particles. We may rewrite Eq.(6.4d) as

$$M\mathbf{R} = \sum m_i \mathbf{r}_i = m_1 \mathbf{r}_1 + m_2 \mathbf{r}_2 + \dots + m_n \mathbf{r}_n \quad (6.7)$$

Differentiating the two sides of the equation with respect to time we get

$$M \frac{d\mathbf{R}}{dt} = m_1 \frac{d\mathbf{r}_1}{dt} + m_2 \frac{d\mathbf{r}_2}{dt} + \dots + m_n \frac{d\mathbf{r}_n}{dt}$$

or

$$M\mathbf{V} = m_1 \mathbf{v}_1 + m_2 \mathbf{v}_2 + \dots + m_n \mathbf{v}_n \quad (6.8)$$

where $\mathbf{v}_1 (= d\mathbf{r}_1/dt)$ is the velocity of the first particle $\mathbf{v}_2 (= d\mathbf{r}_2/dt)$ is the velocity of the second particle etc. and $\mathbf{V} = d\mathbf{R}/dt$ is the velocity of the centre of mass. Note that we assumed the masses m_1, m_2, \dots etc. do not change in time. We have therefore, treated them as constants in differentiating the equations with respect to time.

Differentiating Eq.(6.8) with respect to time, we obtain

$$M \frac{d\mathbf{V}}{dt} = m_1 \frac{d\mathbf{v}_1}{dt} + m_2 \frac{d\mathbf{v}_2}{dt} + \dots + m_n \frac{d\mathbf{v}_n}{dt}$$

or

$$M\mathbf{A} = m_1 \mathbf{a}_1 + m_2 \mathbf{a}_2 + \dots + m_n \mathbf{a}_n \quad (6.9)$$

where $\mathbf{a}_1 (= d\mathbf{v}_1/dt)$ is the acceleration of the first particle, $\mathbf{a}_2 (= d\mathbf{v}_2/dt)$ is the acceleration of the second particle etc. and $\mathbf{A} (= d\mathbf{V}/dt)$ is the acceleration of the centre of mass of the system of particles.

Now, from Newton's second law, the force acting on the first particle is given by $\mathbf{F}_1 = m_1 \mathbf{a}_1$. The force acting on the second particle is given by $\mathbf{F}_2 = m_2 \mathbf{a}_2$ and so on. Eq. (6.9) may be written as

$$M\mathbf{A} = \mathbf{F}_1 + \mathbf{F}_2 + \dots + \mathbf{F}_n \quad (6.10)$$

Thus, the total mass of a system of particles times the acceleration of its centre of mass is the vector sum of all the forces acting on the system of particles.

Note when we talk of the force \mathbf{F}_1 on the first particle, it is not a single force, but the vector sum of all the forces on the first particle; likewise for the second particle etc. Among these forces on each particle there will be **external** forces exerted by bodies outside the system and also **internal** forces exerted by the particles on one another. We know from Newton's third law that these internal forces occur in equal and opposite pairs and in the sum of forces of Eq. (6.10), their contribution is zero. Only the external forces contribute to the equation. We can then rewrite Eq. (6.10) as

$$M\mathbf{A} = \mathbf{F}_{ext} \quad (6.11)$$

where \mathbf{F}_{ext} represents the sum of all external forces acting on the particles of the system.

Eq. (6.11) states that **the centre of mass of a system of particles moves as if all the mass of the system was concentrated at the centre of mass and all the external forces were applied at that point.**

Notice, to determine the motion of the centre of mass no knowledge of internal forces of the system of particles is required; for this purpose we need to know only the external forces.

To obtain Eq. (6.11) we did not need to specify the nature of the system of particles. The system may be a collection of particles in which there may be all kinds of internal motions, or it may be a rigid body which has either pure translational motion or a combination of translational and rotational motion. Whatever is the system and the motion of its individual particles, the centre of mass moves according to Eq. (6.11).

Instead of treating extended bodies as single particles as we have done in earlier chapters, we can now treat them as systems of particles. We can obtain the translational component of their motion, i.e. the motion of the centre of mass of the system, by taking the mass of the whole system to be concentrated at the centre of mass and all the external forces on the system to be acting at the centre of mass.

This is the procedure that we followed earlier in analysing forces on bodies and solving

problems without explicitly outlining and justifying the procedure. We now realise that in earlier studies we assumed, without saying so, that rotational motion and/or internal motion of the particles were either absent or negligible. We no longer need to do this. We have not only found the justification of the procedure we followed earlier; but we also have found how to describe and separate the translational motion of (1) a rigid body which may be rotating as well, or (2) a system of particles with all kinds of internal motion.

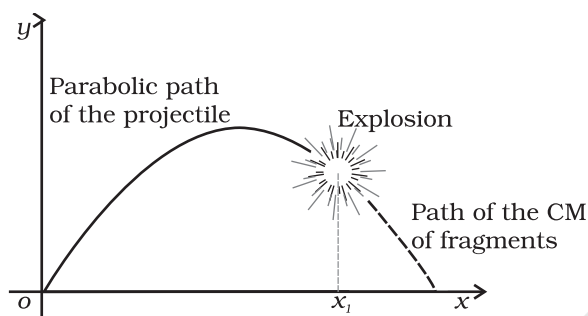

Fig. 6.12 The centre of mass of the fragments of the projectile continues along the same parabolic path which it would have followed if there were no explosion.

Figure 6.12 is a good illustration of Eq. (6.11). A projectile, following the usual parabolic trajectory, explodes into fragments midway in air. The forces leading to the explosion are internal forces. They contribute nothing to the motion of the centre of mass. The total external force, namely, the force of gravity acting on the body, is the same before and after the explosion. The centre of mass under the influence of the external force continues, therefore, along the same parabolic trajectory as it would have followed if there were no explosion.

6.4 LINEAR MOMENTUM OF A SYSTEM OF PARTICLES

Let us recall that the linear momentum of a particle is defined as

$$\mathbf{p} = m \mathbf{v} \quad (6.12)$$

Let us also recall that Newton's second law written in symbolic form for a single particle is

$$\mathbf{F} = \frac{d\mathbf{p}}{dt} \quad (6.13)$$

where \mathbf{F} is the force on the particle. Let us consider a system of n particles with masses m_1, m_2, \dots, m_n respectively and velocities $\mathbf{v}_1, \mathbf{v}_2, \dots, \mathbf{v}_n$ respectively. The particles may be interacting and have external forces acting on them. The linear momentum of the first particle is $m_1 \mathbf{v}_1$, of the second particle is $m_2 \mathbf{v}_2$ and so on.

For the system of n particles, the linear momentum of the system is defined to be the vector sum of all individual particles of the system,

$$\begin{aligned} \mathbf{P} &= \mathbf{p}_1 + \mathbf{p}_2 + \dots + \mathbf{p}_n \\ &= m_1 \mathbf{v}_1 + m_2 \mathbf{v}_2 + \dots + m_n \mathbf{v}_n \end{aligned} \quad (6.14)$$

Comparing this with Eq. (6.8)

$$\mathbf{P} = M \mathbf{V} \quad (6.15)$$

Thus, **the total momentum of a system of particles is equal to the product of the total mass of the system and the velocity of its centre of mass.** Differentiating Eq. (6.15) with respect to time,

$$\frac{d\mathbf{P}}{dt} = M \frac{d\mathbf{V}}{dt} = M \mathbf{A} \quad (6.16)$$

Comparing Eq. (6.16) and Eq. (6.11),

$$\frac{d\mathbf{P}}{dt} = \mathbf{F}_{ext} \quad (6.17)$$

This is the statement of **Newton's second law of motion extended to a system of particles.**

Suppose now, that the sum of external forces acting on a system of particles is zero. Then from Eq. (6.17)

$$\frac{d\mathbf{P}}{dt} = 0 \quad \text{or} \quad \mathbf{P} = \text{Constant} \quad (6.18a)$$

Thus, when the total external force acting on a system of particles is zero, the total linear momentum of the system is constant. This is the law of conservation of the total linear momentum of a system of particles. Because of Eq. (6.15), this also means that when the total external force on the system is zero the velocity of the centre of mass remains constant. (We assume throughout the discussion on systems of particles in this chapter that the total mass of the system remains constant.)

Note that on account of the internal forces, i.e. the forces exerted by the particles on one another, the individual particles may have

complicated trajectories. Yet, if the total external force acting on the system is zero, the centre of mass moves with a constant velocity, i.e., moves uniformly in a straight line like a free particle.

The vector Eq. (6.18a) is equivalent to three scalar equations,

$$P_x = c_1, P_y = c_2 \text{ and } P_z = c_3 \quad (6.18 b)$$

Here P_x , P_y and P_z are the components of the total linear momentum vector \mathbf{P} along the x -, y - and z -axes respectively; c_1 , c_2 and c_3 are constants.

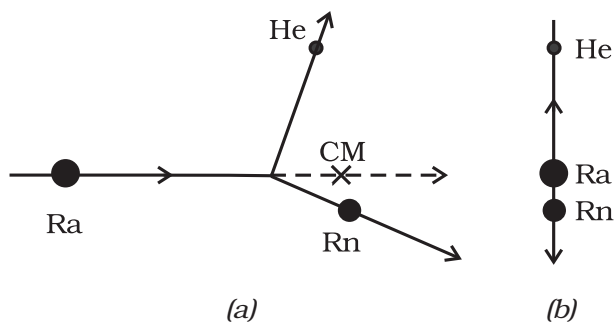

Fig. 6.13 (a) A heavy nucleus radium (Ra) splits into a lighter nucleus radon (Rn) and an alpha particle (nucleus of helium atom). The CM of the system is in uniform motion.
(b) The same splitting of the heavy nucleus radium (Ra) with the centre of mass at rest. The two product particles fly back to back.

As an example, let us consider the radioactive decay of a moving unstable particle, like the nucleus of radium. A radium nucleus disintegrates into a nucleus of radon and an alpha particle. The forces leading to the decay are internal to the system and the external forces on the system are negligible. So the total linear momentum of the system is the same before and after decay. The two particles produced in the decay, the radon nucleus and the alpha particle, move in different directions in such a way that their centre of mass moves along the same path along which the original decaying radium nucleus was moving [Fig. 6.13(a)].

If we observe the decay from the frame of reference in which the centre of mass is at rest, the motion of the particles involved in the decay looks particularly simple; the product particles

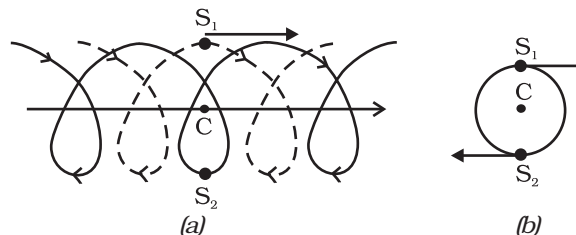

Fig. 6.14 (a) Trajectories of two stars, S_1 (dotted line) and S_2 (solid line) forming a binary system with their centre of mass C in uniform motion.
(b) The same binary system, with the centre of mass C at rest.

move back to back with their centre of mass remaining at rest as shown in Fig.6.13 (b).

In many problems on the system of particles, as in the above radioactive decay problem, it is convenient to work in the centre of mass frame rather than in the laboratory frame of reference.

In astronomy, binary (double) stars is a common occurrence. If there are no external forces, the centre of mass of a double star moves like a free particle, as shown in Fig.6.14 (a). The trajectories of the two stars of equal mass are also shown in the figure; they look complicated. If we go to the centre of mass frame, then we find that there the two stars are moving in a circle, about the centre of mass, which is at rest. Note that the position of the stars have to be diametrically opposite to each other [Fig. 6.14(b)]. Thus in our frame of reference, the trajectories of the stars are a combination of (i) uniform motion in a straight line of the centre of mass and (ii) circular orbits of the stars about the centre of mass.

As can be seen from the two examples, **separating** the motion of different parts of a system into motion **of the centre of mass and motion about the centre of mass** is a very useful technique that helps in understanding the motion of the system.

6.5 VECTOR PRODUCT OF TWO VECTORS

We are already familiar with vectors and their use in physics. In chapter 5 (Work, Energy, Power) we defined the scalar product of two vectors. An important physical quantity, work, is defined as a scalar product of two vector quantities, force and displacement.

We shall now define another product of two vectors. This product is a vector. Two important quantities in the study of rotational motion, namely, moment of a force and angular momentum, are defined as vector products.

Definition of Vector Product

A vector product of two vectors \mathbf{a} and \mathbf{b} is a vector \mathbf{c} such that

- magnitude of $\mathbf{c} = c = ab \sin \theta$ where a and b are magnitudes of \mathbf{a} and \mathbf{b} and θ is the angle between the two vectors.
- \mathbf{c} is perpendicular to the plane containing \mathbf{a} and \mathbf{b} .
- if we take a right handed screw with its head lying in the plane of \mathbf{a} and \mathbf{b} and the screw perpendicular to this plane, and if we turn the head in the direction from \mathbf{a} to \mathbf{b} , then the tip of the screw advances in the direction of \mathbf{c} . This right handed screw rule is illustrated in Fig. 6.15a.

Alternately, if one curls up the fingers of right hand around a line perpendicular to the plane of the vectors \mathbf{a} and \mathbf{b} and if the fingers are curled up in the direction from \mathbf{a} to \mathbf{b} , then the stretched thumb points in the direction of \mathbf{c} , as shown in Fig. 6.15b.

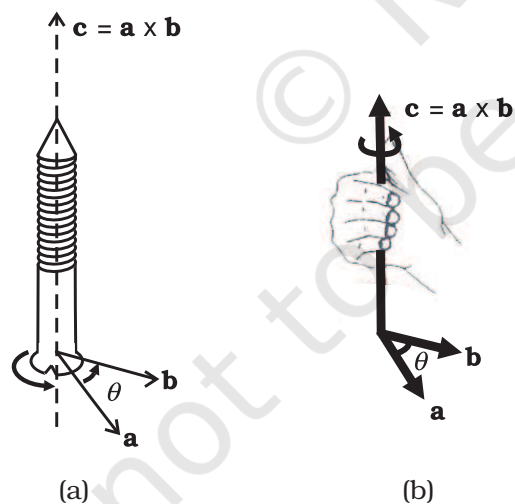

Fig. 6.15 (a) Rule of the right handed screw for defining the direction of the vector product of two vectors.

(b) Rule of the right hand for defining the direction of the vector product.

A simpler version of the right hand rule is the following : Open up your right hand palm and curl the fingers pointing from \mathbf{a} to \mathbf{b} . Your stretched thumb points in the direction of \mathbf{c} .

It should be remembered that there are two angles between any two vectors \mathbf{a} and \mathbf{b} . In Fig. 6.15 (a) or (b) they correspond to θ (as shown) and $(360^\circ - \theta)$. While applying either of the above rules, the rotation should be taken through the smaller angle ($<180^\circ$) between \mathbf{a} and \mathbf{b} . It is θ here.

Because of the cross (\times) used to denote the vector product, it is also referred to as cross product.

- Note that scalar product of two vectors is commutative as said earlier, $\mathbf{a} \cdot \mathbf{b} = \mathbf{b} \cdot \mathbf{a}$. The vector product, however, is not commutative, i.e. $\mathbf{a} \times \mathbf{b} \neq \mathbf{b} \times \mathbf{a}$.

The magnitude of both $\mathbf{a} \times \mathbf{b}$ and $\mathbf{b} \times \mathbf{a}$ is the same ($ab \sin \theta$); also, both of them are perpendicular to the plane of \mathbf{a} and \mathbf{b} . But the rotation of the right-handed screw in case of $\mathbf{a} \times \mathbf{b}$ is from \mathbf{a} to \mathbf{b} , whereas in case of $\mathbf{b} \times \mathbf{a}$ it is from \mathbf{b} to \mathbf{a} . This means the two vectors are in opposite directions. We have

$$\mathbf{a} \times \mathbf{b} = -\mathbf{b} \times \mathbf{a}$$

- Another interesting property of a vector product is its behaviour under reflection. Under reflection (i.e. on taking the plane mirror image) we have $x \rightarrow -x, y \rightarrow -y$ and $z \rightarrow -z$. As a result all the components of a vector change sign and thus $a \rightarrow -a, b \rightarrow -b$. What happens to $\mathbf{a} \times \mathbf{b}$ under reflection?

$$\mathbf{a} \times \mathbf{b} \rightarrow (-\mathbf{a}) \times (-\mathbf{b}) = \mathbf{a} \times \mathbf{b}$$

Thus, $\mathbf{a} \times \mathbf{b}$ does not change sign under reflection.

- Both scalar and vector products are distributive with respect to vector addition. Thus,

$$\mathbf{a} \cdot (\mathbf{b} + \mathbf{c}) = \mathbf{a} \cdot \mathbf{b} + \mathbf{a} \cdot \mathbf{c}$$

$$\mathbf{a} \times (\mathbf{b} + \mathbf{c}) = \mathbf{a} \times \mathbf{b} + \mathbf{a} \times \mathbf{c}$$

- We may write $\mathbf{c} = \mathbf{a} \times \mathbf{b}$ in the component form. For this we first need to obtain some elementary cross products:

(i) $\mathbf{a} \times \mathbf{a} = \mathbf{0}$ ($\mathbf{0}$ is a null vector, i.e. a vector with zero magnitude)

This follows since magnitude of $\mathbf{a} \times \mathbf{a}$ is $a^2 \sin 0^\circ = 0$.

From this follow the results

(i) $\hat{i} \times \hat{i} = \mathbf{0}, \hat{j} \times \hat{j} = \mathbf{0}, \hat{k} \times \hat{k} = \mathbf{0}$

(ii) $\hat{i} \times \hat{j} = \hat{k}$

Note that the magnitude of $\hat{i} \times \hat{j}$ is $\sin 90^\circ$ or 1, since \hat{i} and \hat{j} both have unit magnitude and the angle between them is 90° . Thus, $\hat{i} \times \hat{j}$ is a unit vector. A unit vector perpendicular to the plane of \hat{i} and \hat{j} and related to them by the right hand screw rule is \hat{k} . Hence, the above result. You may verify similarly,

$\hat{j} \times \hat{k} = \hat{i}$ and $\hat{k} \times \hat{i} = \hat{j}$

From the rule for commutation of the cross product, it follows:

$\hat{j} \times \hat{i} = -\hat{k}, \hat{k} \times \hat{j} = -\hat{i}, \hat{i} \times \hat{k} = -\hat{j}$

Note if $\hat{i}, \hat{j}, \hat{k}$ occur cyclically in the above vector product relation, the vector product is positive. If $\hat{i}, \hat{j}, \hat{k}$ do not occur in cyclic order, the vector product is negative.

Now,

$$\begin{aligned} \mathbf{a} \times \mathbf{b} &= (a_x \hat{i} + a_y \hat{j} + a_z \hat{k}) \times (b_x \hat{i} + b_y \hat{j} + b_z \hat{k}) \\ &= a_x b_y \hat{k} - a_x b_z \hat{j} - a_y b_x \hat{k} + a_y b_z \hat{i} + a_z b_x \hat{j} - a_z b_y \hat{i} \\ &= (a_y b_z - a_z b_y) \hat{i} + (a_z b_x - a_x b_z) \hat{j} + (a_x b_y - a_y b_x) \hat{k} \end{aligned}$$

We have used the elementary cross products in obtaining the above relation. The expression for $\mathbf{a} \times \mathbf{b}$ can be put in a determinant form which is easy to remember.

$$\mathbf{a} \times \mathbf{b} = \begin{vmatrix} \hat{i} & \hat{j} & \hat{k} \\ a_x & a_y & a_z \\ b_x & b_y & b_z \end{vmatrix}$$

► **Example 6.4** Find the scalar and vector products of two vectors. $\mathbf{a} = (3\hat{i} - 4\hat{j} + 5\hat{k})$ and $\mathbf{b} = (-2\hat{i} + \hat{j} + 3\hat{k})$

Answer

$$\begin{aligned} \mathbf{a} \cdot \mathbf{b} &= (3\hat{i} - 4\hat{j} + 5\hat{k}) \cdot (-2\hat{i} + \hat{j} - 3\hat{k}) \\ &= -6 - 4 - 15 \\ &= -25 \end{aligned}$$

$$\mathbf{a} \times \mathbf{b} = \begin{vmatrix} \hat{i} & \hat{j} & \hat{k} \\ 3 & -4 & 5 \\ -2 & 1 & -3 \end{vmatrix} = 7\hat{i} - \hat{j} - 5\hat{k}$$

Note $\mathbf{b} \times \mathbf{a} = -7\hat{i} + \hat{j} + 5\hat{k}$

6.6 ANGULAR VELOCITY AND ITS RELATION WITH LINEAR VELOCITY

In this section we shall study what is angular velocity and its role in rotational motion. We have seen that every particle of a rotating body moves in a circle. The linear velocity of the particle is related to the angular velocity. The relation between these two quantities involves a vector product which we learnt about in the last section.

Let us go back to Fig. 6.4. As said above, in rotational motion of a rigid body about a fixed axis, every particle of the body moves in a circle,

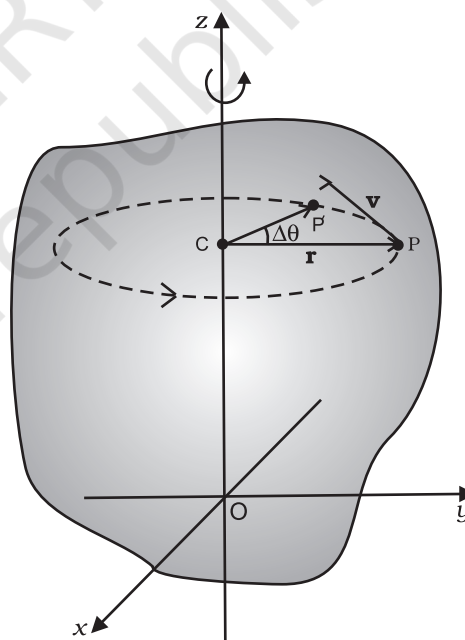

Fig. 6.16 Rotation about a fixed axis. (A particle (P) of the rigid body rotating about the fixed (z-) axis moves in a circle with centre (C) on the axis.)

which lies in a plane perpendicular to the axis and has its centre on the axis. In Fig. 6.16 we redraw Fig. 6.4, showing a typical particle (at a point P) of the rigid body rotating about a fixed axis (taken as the z-axis). The particle describes

a circle with a centre C on the axis. The radius of the circle is r , the perpendicular distance of the point P from the axis. We also show the linear velocity vector \mathbf{v} of the particle at P . It is along the tangent at P to the circle.

Let P' be the position of the particle after an interval of time Δt (Fig. 6.16). The angle PCP' describes the angular displacement $\Delta\theta$ of the particle in time Δt . The average angular velocity of the particle over the interval Δt is $\Delta\theta/\Delta t$. As Δt tends to zero (i.e. takes smaller and smaller values), the ratio $\Delta\theta/\Delta t$ approaches a limit which is the instantaneous angular velocity $d\theta/dt$ of the particle at the position P . We denote the **instantaneous angular velocity** by ω (the Greek letter omega). We know from our study of circular motion that the magnitude of linear velocity v of a particle moving in a circle is related to the angular velocity of the particle ω by the simple relation $v = \omega r$, where r is the radius of the circle.

We observe that at any given instant the relation $v = \omega r$ applies to all particles of the rigid body. Thus for a particle at a perpendicular distance r_i from the fixed axis, the linear velocity at a given instant v_i is given by

$$v_i = \omega r_i \quad (6.19)$$

The index i runs from 1 to n , where n is the total number of particles of the body.

For particles on the axis, $r = 0$, and hence $v = \omega r = 0$. Thus, particles on the axis are stationary. This verifies that the axis is *fixed*.

Note that we use the same angular velocity ω for all the particles. **We therefore, refer to ω as the angular velocity of the whole body.**

We have characterised pure translation of a body by all parts of the body having the same velocity at any instant of time. Similarly, we may characterise pure rotation by all parts of the body having the same angular velocity at any instant of time. Note that this characterisation of the rotation of a rigid body about a fixed axis is **just another way** of saying as in Sec. 6.1 that each particle of the body moves in a circle, which lies in a plane perpendicular to the axis and has the centre on the axis.

In our discussion so far the angular velocity appears to be a scalar. In fact, it is a vector. We shall not justify this fact, but we shall accept it. For rotation about a fixed axis, the angular velocity vector lies along the axis of rotation,

and points out in the direction in which a right handed screw would advance, if the head of the screw is rotated with the body. (See Fig. 6.17a).

The magnitude of this vector is $\omega = d\theta/dt$ referred as above.

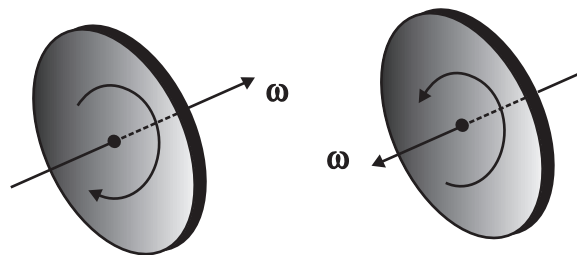

Fig. 6.17 (a) If the head of a right handed screw rotates with the body, the screw advances in the direction of the angular velocity ω . If the sense (clockwise or anticlockwise) of rotation of the body changes, so does the direction of ω .

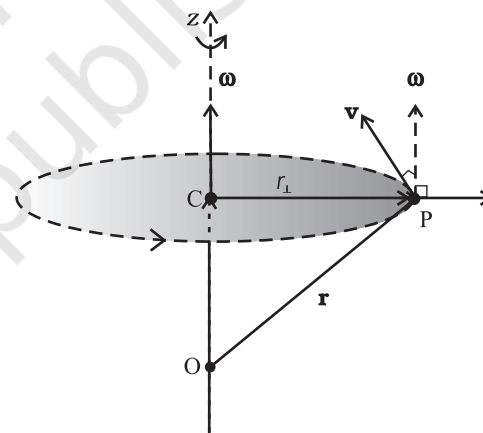

Fig. 6.17 (b) The angular velocity vector ω is directed along the fixed axis as shown. The linear velocity of the particle at P is $\mathbf{v} = \omega \times \mathbf{r}$. It is perpendicular to both ω and \mathbf{r} and is directed along the tangent to the circle described by the particle.

We shall now look at what the vector product $\omega \times \mathbf{r}$ corresponds to. Refer to Fig. 6.17(b) which is a part of Fig. 6.16 reproduced to show the path of the particle P . The figure shows the vector ω directed along the fixed (z -) axis and also the position vector $\mathbf{r} = \mathbf{OP}$ of the particle at P of the rigid body with respect to the origin O . Note that the origin is chosen to be on the axis of rotation.

Now $\boldsymbol{\omega} \times \mathbf{r} = \boldsymbol{\omega} \times \mathbf{OP} = \boldsymbol{\omega} \times (\mathbf{OC} + \mathbf{CP})$
 But $\boldsymbol{\omega} \times \mathbf{OC} = \mathbf{0}$ as $\boldsymbol{\omega}$ is along \mathbf{OC}
 Hence $\boldsymbol{\omega} \times \mathbf{r} = \boldsymbol{\omega} \times \mathbf{CP}$

The vector $\boldsymbol{\omega} \times \mathbf{CP}$ is perpendicular to $\boldsymbol{\omega}$, i.e. to the z -axis and also to \mathbf{CP} , the radius of the circle described by the particle at P. It is therefore, along the tangent to the circle at P. Also, the magnitude of $\boldsymbol{\omega} \times \mathbf{CP}$ is ω (CP) since $\boldsymbol{\omega}$ and \mathbf{CP} are perpendicular to each other. We shall denote \mathbf{CP} by \mathbf{r}_\perp and not by \mathbf{r} , as we did earlier.

Thus, $\boldsymbol{\omega} \times \mathbf{r}$ is a vector of magnitude ωr_\perp and is along the tangent to the circle described by the particle at P. The linear velocity vector \mathbf{v} at P has the same magnitude and direction. Thus,

$$\mathbf{v} = \boldsymbol{\omega} \times \mathbf{r} \quad (6.20)$$

In fact, the relation, Eq. (6.20), holds good even for rotation of a rigid body with one point fixed, such as the rotation of the top [Fig. 6.6(a)]. In this case \mathbf{r} represents the position vector of the particle with respect to the fixed point taken as the origin.

We note that **for rotation about a fixed axis, the direction of the vector $\boldsymbol{\omega}$ does not change with time. Its magnitude may, however, change from instant to instant. For the more general rotation, both the magnitude and the direction of $\boldsymbol{\omega}$ may change from instant to instant.**

6.6.1 Angular acceleration

You may have noticed that we are developing the study of rotational motion along the lines of the study of translational motion with which we are already familiar. Analogous to the kinetic variables of linear displacement (\mathbf{s}) and velocity (\mathbf{v}) in translational motion, we have angular displacement ($\boldsymbol{\theta}$) and angular velocity ($\boldsymbol{\omega}$) in rotational motion. It is then natural to define in rotational motion the concept of angular acceleration in analogy with linear acceleration defined as the time rate of change of velocity in translational motion. We define angular acceleration $\boldsymbol{\alpha}$ as the time rate of change of angular velocity. Thus,

$$\boldsymbol{\alpha} = \frac{d\boldsymbol{\omega}}{dt} \quad (6.21)$$

If the axis of rotation is fixed, the direction of $\boldsymbol{\omega}$ and hence, that of $\boldsymbol{\alpha}$ is fixed. In this case the vector equation reduces to a scalar equation

$$\alpha = \frac{d\omega}{dt} \quad (6.22)$$

6.7 TORQUE AND ANGULAR MOMENTUM

In this section, we shall acquaint ourselves with two physical quantities (torque and angular momentum) which are defined as vector products of two vectors. These as we shall see, are especially important in the discussion of motion of systems of particles, particularly rigid bodies.

6.7.1 Moment of force (Torque)

We have learnt that the motion of a rigid body, in general, is a combination of rotation and translation. If the body is fixed at a point or along a line, it has only rotational motion. We know that force is needed to change the translational state of a body, i.e. to produce linear acceleration. We may then ask, what is the analogue of force in the case of rotational motion? To look into the question in a concrete situation let us take the example of opening or closing of a door. A door is a rigid body which can rotate about a fixed vertical axis passing through the hinges. What makes the door rotate? It is clear that unless a force is applied the door does not rotate. But any force does not do the job. A force applied to the hinge line cannot produce any rotation at all, whereas a force of given magnitude applied at right angles to the door at its outer edge is most effective in producing rotation. It is not the force alone, but how and where the force is applied is important in rotational motion.

The rotational analogue of force in linear motion is **moment of force**. It is also referred to as **torque** or **couple**. (We shall use the words moment of force and torque interchangeably.) We shall first define the moment of force for the special case of a single particle. Later on we shall extend the concept to systems of particles including rigid bodies. We shall also relate it to a change in the state of rotational motion, i.e. is angular acceleration of a rigid body.

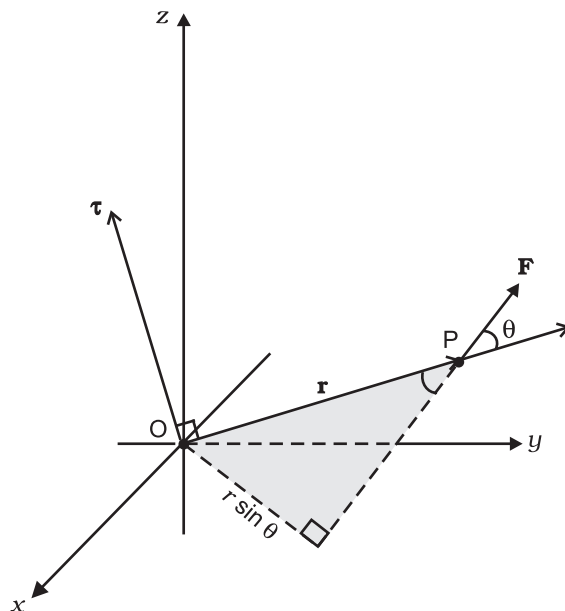

Fig. 6.18 $\boldsymbol{\tau} = \mathbf{r} \times \mathbf{F}$, $\boldsymbol{\tau}$ is perpendicular to the plane containing \mathbf{r} and \mathbf{F} , and its direction is given by the right handed screw rule.

If a force acts on a single particle at a point P whose position with respect to the origin O is given by the position vector \mathbf{r} (Fig. 6.18), the moment of the force acting on the particle with respect to the origin O is defined as the vector product

$$\boldsymbol{\tau} = \mathbf{r} \times \mathbf{F} \quad (6.23)$$

The moment of force (or torque) is a vector quantity. The symbol $\boldsymbol{\tau}$ stands for the Greek letter *tau*. The magnitude of $\boldsymbol{\tau}$ is

$$\tau = r F \sin \theta \quad (6.24a)$$

where r is the magnitude of the position vector \mathbf{r} , i.e. the length OP, F is the magnitude of force \mathbf{F} and θ is the angle between \mathbf{r} and \mathbf{F} as shown.

Moment of force has dimensions $M L^2 T^{-2}$. Its dimensions are the same as those of work or energy. It is, however, a very different physical quantity than work. Moment of a force is a vector, while work is a scalar. The SI unit of moment of force is newton metre (N m). The magnitude of the moment of force may be written

$$\tau = (r \sin \theta) F = r_{\perp} F \quad (6.24b)$$

$$\text{or } \tau = r F \sin \theta = r F_{\perp} \quad (6.24c)$$

where $r_{\perp} = r \sin \theta$ is the perpendicular distance

of the line of action of \mathbf{F} from the origin and $F_{\perp} (= F \sin \theta)$ is the component of \mathbf{F} in the direction perpendicular to \mathbf{r} . Note that $\tau = 0$ if $r = 0$, $F = 0$ or $\theta = 0^\circ$ or 180° . Thus, the moment of a force vanishes if either the magnitude of the force is zero, or if the line of action of the force passes through the origin.

One may note that since $\mathbf{r} \times \mathbf{F}$ is a vector product, properties of a vector product of two vectors apply to it. If the direction of \mathbf{F} is reversed, the direction of the moment of force is reversed. If directions of both \mathbf{r} and \mathbf{F} are reversed, the direction of the moment of force remains the same.

6.7.2 Angular momentum of a particle

Just as the moment of a force is the rotational analogue of force in linear motion, the quantity angular momentum is the rotational analogue of linear momentum. We shall first define angular momentum for the special case of a single particle and look at its usefulness in the context of single particle motion. We shall then extend the definition of angular momentum to systems of particles including rigid bodies.

Like moment of a force, angular momentum is also a vector product. It could also be referred to as moment of (linear) momentum. From this term one could guess how angular momentum is defined.

Consider a particle of mass m and linear momentum \mathbf{p} at a position \mathbf{r} relative to the origin O. The angular momentum l of the particle with respect to the origin O is defined to be

$$l = \mathbf{r} \times \mathbf{p} \quad (6.25a)$$

The magnitude of the angular momentum vector is

$$l = r p \sin \theta \quad (6.26a)$$

where p is the magnitude of \mathbf{p} and θ is the angle between \mathbf{r} and \mathbf{p} . We may write

$$l = r p_{\perp} \text{ or } r_{\perp} p \quad (6.26b)$$

where $r_{\perp} (= r \sin \theta)$ is the perpendicular distance of the directional line of \mathbf{p} from the origin and $p_{\perp} (= p \sin \theta)$ is the component of \mathbf{p} in a direction perpendicular to \mathbf{r} . We expect the angular momentum to be zero ($l = 0$), if the linear momentum vanishes ($p = 0$), if the particle is at the origin ($r = 0$), or if the directional line of \mathbf{p} passes through the origin $\theta = 0^\circ$ or 180° .

The physical quantities, moment of a force and angular momentum, have an important relation between them. It is the rotational analogue of the relation between force and linear momentum. For deriving the relation in the context of a single particle, we differentiate $\mathbf{l} = \mathbf{r} \times \mathbf{p}$ with respect to time,

$$\frac{d\mathbf{l}}{dt} = \frac{d}{dt}(\mathbf{r} \times \mathbf{p})$$

Applying the product rule for differentiation to the right hand side,

$$\frac{d}{dt}(\mathbf{r} \times \mathbf{p}) = \frac{d\mathbf{r}}{dt} \times \mathbf{p} + \mathbf{r} \times \frac{d\mathbf{p}}{dt}$$

Now, the velocity of the particle is $\mathbf{v} = d\mathbf{r}/dt$ and $\mathbf{p} = m\mathbf{v}$

Because of this $\frac{d\mathbf{r}}{dt} \times \mathbf{p} = \mathbf{v} \times m\mathbf{v} = 0$,

as the vector product of two parallel vectors vanishes. Further, since $d\mathbf{p}/dt = \mathbf{F}$,

$$\mathbf{r} \times \frac{d\mathbf{p}}{dt} = \mathbf{r} \times \mathbf{F} = \boldsymbol{\tau}$$

Hence $\frac{d}{dt}(\mathbf{r} \times \mathbf{p}) = \boldsymbol{\tau}$

or $\frac{d\mathbf{l}}{dt} = \boldsymbol{\tau}$ (6.27)

Thus, the time rate of change of the angular momentum of a particle is equal to the torque acting on it. This is the rotational analogue of the equation $\mathbf{F} = d\mathbf{p}/dt$, which expresses Newton's second law for the translational motion of a single particle.

Torque and angular momentum for a system of particles

To get the total angular momentum of a system of particles about a given point we need to add vectorially the angular momenta of individual particles. Thus, for a system of n particles,

$$\mathbf{L} = \mathbf{l}_1 + \mathbf{l}_2 + \dots + \mathbf{l}_n = \sum_{i=1}^n \mathbf{l}_i$$

The angular momentum of the i^{th} particle is given by

$$\mathbf{l}_i = \mathbf{r}_i \times \mathbf{p}_i$$

where \mathbf{r}_i is the position vector of the i^{th} particle with respect to a given origin and $\mathbf{p} = (m_i\mathbf{v}_i)$ is the linear momentum of the particle. (The

An experiment with the bicycle rim

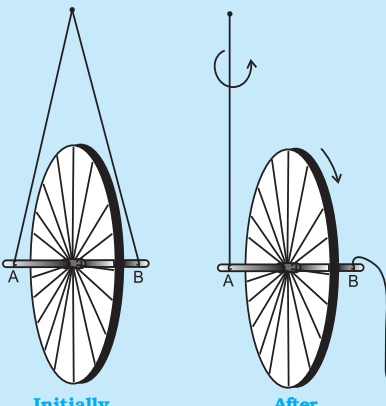

Take a bicycle rim and extend its axle on both sides. Tie two strings at both ends A and B, as shown in the adjoining figure. Hold both the strings together in one hand such that the rim is vertical. If you leave one string, the rim will tilt. Now keeping the rim in vertical position with both the strings in one hand, put the wheel in fast rotation around the axle with the other hand. Then leave one string, say B, from your hand, and observe what happens.

The rim keeps rotating in a vertical plane and the plane of rotation turns around the string A which you are holding. We say that the axis of rotation of the rim or equivalently its angular momentum precesses about the string A.

The rotating rim gives rise to an angular momentum. Determine the direction of this angular momentum. When you are holding the rotating rim with string A, a torque is generated. (We leave it to you to find out how the torque is generated and what its direction is.) The effect of the torque on the angular momentum is to make it precess around an axis perpendicular to both the angular momentum and the torque. Verify all these statements.

particle has mass m_i and velocity \mathbf{v}_i) We may write the total angular momentum of a system of particles as

$$\mathbf{L} = \sum \mathbf{l}_i = \sum_i \mathbf{r}_i \times \mathbf{p}_i \tag{6.25b}$$

This is a generalisation of the definition of angular momentum (Eq. 6.25a) for a single particle to a system of particles.

Using Eqs. (6.23) and (6.25b), we get

$$\frac{d\mathbf{L}}{dt} = \frac{d}{dt}(\sum \mathbf{l}_i) = \sum_i \frac{d\mathbf{l}_i}{dt} = \sum_i \boldsymbol{\tau}_i \quad (6.28a)$$

where $\boldsymbol{\tau}_i$ is the torque acting on the i^{th} particle;

$$\boldsymbol{\tau}_i = \mathbf{r}_i \times \mathbf{F}_i$$

The force \mathbf{F}_i on the i^{th} particle is the vector sum of external forces $\mathbf{F}_i^{\text{ext}}$ acting on the particle and the internal forces $\mathbf{F}_i^{\text{int}}$ exerted on it by the other particles of the system. We may therefore separate the contribution of the external and the internal forces to the total torque

$$\boldsymbol{\tau} = \sum_i \boldsymbol{\tau}_i = \sum_i \mathbf{r}_i \times \mathbf{F}_i \quad \text{as}$$

$$\boldsymbol{\tau} = \boldsymbol{\tau}_{\text{ext}} + \boldsymbol{\tau}_{\text{int}},$$

$$\text{where } \boldsymbol{\tau}_{\text{ext}} = \sum_i \mathbf{r}_i \times \mathbf{F}_i^{\text{ext}}$$

$$\text{and } \boldsymbol{\tau}_{\text{int}} = \sum_i \mathbf{r}_i \times \mathbf{F}_i^{\text{int}}$$

We shall assume not only Newton's third law of motion, i.e. the forces between any two particles of the system are equal and opposite, but also that these forces are directed along the line joining the two particles. In this case the contribution of the internal forces to the total torque on the system is zero, since the torque resulting from each action-reaction pair of forces is zero. We thus have, $\boldsymbol{\tau}_{\text{int}} = \mathbf{0}$ and therefore $\boldsymbol{\tau} = \boldsymbol{\tau}_{\text{ext}}$.

Since $\boldsymbol{\tau} = \sum \boldsymbol{\tau}_i$, it follows from Eq. (6.28a) that

$$\frac{d\mathbf{L}}{dt} = \boldsymbol{\tau}_{\text{ext}} \quad (6.28b)$$

Thus, **the time rate of the total angular momentum of a system of particles about a point** (taken as the origin of our frame of reference) **is equal to the sum of the external torques** (i.e. the torques due to external forces) **acting on the system taken about the same point.** Eq. (6.28 b) is the generalisation of the single particle case of Eq. (6.23) to a system of particles. Note that when we have only one particle, there are no internal forces or torques. Eq.(6.28 b) is the rotational analogue of

$$\frac{d\mathbf{P}}{dt} = \mathbf{F}_{\text{ext}} \quad (6.17)$$

Note that like Eq.(6.17), Eq.(6.28b) holds good for any system of particles, whether it is a rigid body or its individual particles have all kinds of internal motion.

Conservation of angular momentum

If $\boldsymbol{\tau}_{\text{ext}} = \mathbf{0}$, Eq. (6.28b) reduces to

$$\frac{d\mathbf{L}}{dt} = 0$$

$$\text{or } \mathbf{L} = \text{constant.} \quad (6.29a)$$

Thus, if the total external torque on a system of particles is zero, then the total angular momentum of the system is conserved, i.e. remains constant. Eq. (6.29a) is equivalent to three scalar equations,

$$L_x = K_1, L_y = K_2 \text{ and } L_z = K_3 \quad (6.29b)$$

Here K_1, K_2 and K_3 are constants; L_x, L_y and L_z are the components of the total angular momentum vector \mathbf{L} along the x,y and z axes respectively. The statement that the total angular momentum is conserved means that each of these three components is conserved.

Eq. (6.29a) is the rotational analogue of Eq. (6.18a), i.e. the conservation law of the total linear momentum for a system of particles. Like Eq. (6.18a), it has applications in many practical situations. We shall look at a few of the interesting applications later on in this chapter.

► **Example 6.5** Find the torque of a force $7\hat{i} + 3\hat{j} - 5\hat{k}$ about the origin. The force acts on a particle whose position vector is $\hat{i} - \hat{j} + \hat{k}$.

Answer Here $\mathbf{r} = \hat{i} - \hat{j} + \hat{k}$

$$\text{and } \mathbf{F} = 7\hat{i} + 3\hat{j} - 5\hat{k}.$$

We shall use the determinant rule to find the torque $\boldsymbol{\tau} = \mathbf{r} \times \mathbf{F}$

$$\boldsymbol{\tau} = \begin{vmatrix} \hat{i} & \hat{j} & \hat{k} \\ 1 & -1 & 1 \\ 7 & 3 & -5 \end{vmatrix} = (5-3)\hat{i} - (-5-7)\hat{j} + (3-(-7))\hat{k}$$

$$\text{or } \boldsymbol{\tau} = 2\hat{i} + 12\hat{j} + 10\hat{k} \quad \blacktriangleleft$$

► **Example 6.6** Show that the angular momentum about any point of a single particle moving with constant velocity remains constant throughout the motion.

Answer Let the particle with velocity \mathbf{v} be at point P at some instant t . We want to calculate the angular momentum of the particle about an arbitrary point O.

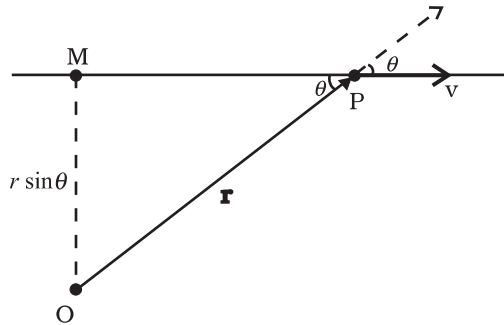

Fig 6.19

The angular momentum is $\mathbf{l} = \mathbf{r} \times m\mathbf{v}$. Its magnitude is $mvr \sin\theta$, where θ is the angle between \mathbf{r} and \mathbf{v} as shown in Fig. 6.19. Although the particle changes position with time, the line of direction of \mathbf{v} remains the same and hence $OM = r \sin\theta$, is a constant.

Further, the direction of \mathbf{l} is perpendicular to the plane of \mathbf{r} and \mathbf{v} . It is into the page of the figure. This direction does not change with time.

Thus, \mathbf{l} remains the same in magnitude and direction and is therefore conserved. Is there any external torque on the particle? ◀

6.8 EQUILIBRIUM OF A RIGID BODY

We are now going to concentrate on the motion of rigid bodies rather than on the motion of general systems of particles.

We shall recapitulate what effect the external forces have on a rigid body. (Henceforth we shall omit the adjective 'external' because unless stated otherwise, we shall deal with only external forces and torques.) The forces change the translational state of the motion of the rigid body, i.e. they change its total linear momentum in accordance with Eq. (6.17). But this is not the only effect the forces have. The total torque on the body may not vanish. Such a torque changes the rotational state of motion of the rigid body, i.e. it changes the total angular momentum of the body in accordance with Eq. (6.28 b).

A rigid body is said to be in mechanical equilibrium, if both its linear momentum and angular momentum are not changing with time, or equivalently, the body has neither linear

acceleration nor angular acceleration. This means

- (1) the total force, i.e. the vector sum of the forces, on the rigid body is zero;

$$\mathbf{F}_1 + \mathbf{F}_2 + \dots + \mathbf{F}_n = \sum_{i=1}^n \mathbf{F}_i = \mathbf{0} \quad (6.30a)$$

If the total force on the body is zero, then the total linear momentum of the body does not change with time. Eq. (6.30a) gives the condition for the translational equilibrium of the body.

- (2) The total torque, i.e. the vector sum of the torques on the rigid body is zero,

$$\boldsymbol{\tau}_1 + \boldsymbol{\tau}_2 + \dots + \boldsymbol{\tau}_n = \sum_{i=1}^n \boldsymbol{\tau}_i = \mathbf{0} \quad (6.30b)$$

If the total torque on the rigid body is zero, the total angular momentum of the body does not change with time. Eq. (6.30 b) gives the condition for the rotational equilibrium of the body.

One may raise a question, whether the rotational equilibrium condition [Eq. 6.30(b)] remains valid, if the origin with respect to which the torques are taken is shifted. One can show that if the translational equilibrium condition [Eq. 6.30(a)] holds for a rigid body, then such a shift of origin does not matter, i.e. the rotational equilibrium condition is independent of the location of the origin about which the torques are taken. Example 6.7 gives a proof of this result in a special case of a couple, i.e. two forces acting on a rigid body in translational equilibrium. The generalisation of this result to n forces is left as an exercise.

Eq. (6.30a) and Eq. (6.30b), both, are vector equations. They are equivalent to three scalar equations each. Eq. (6.30a) corresponds to

$$\sum_{i=1}^n F_{ix} = 0, \quad \sum_{i=1}^n F_{iy} = 0 \quad \text{and} \quad \sum_{i=1}^n F_{iz} = 0 \quad (6.31a)$$

where F_{ix} , F_{iy} and F_{iz} are respectively the x , y and z components of the forces \mathbf{F}_i . Similarly, Eq. (6.30b) is equivalent to three scalar equations

$$\sum_{i=1}^n \tau_{ix} = 0, \quad \sum_{i=1}^n \tau_{iy} = 0 \quad \text{and} \quad \sum_{i=1}^n \tau_{iz} = 0 \quad (6.31b)$$

where τ_{ix} , τ_{iy} and τ_{iz} are respectively the x , y and z components of the torque $\boldsymbol{\tau}_i$.

Eq. (6.31a) and (6.31b) give six independent conditions to be satisfied for mechanical

equilibrium of a rigid body. In a number of problems all the forces acting on the body are coplanar. Then we need only three conditions to be satisfied for mechanical equilibrium. Two of these conditions correspond to translational equilibrium; the sum of the components of the forces along any two perpendicular axes in the plane must be zero. The third condition corresponds to rotational equilibrium. The sum of the components of the torques along any axis perpendicular to the plane of the forces must be zero.

The conditions of equilibrium of a rigid body may be compared with those for a particle, which we considered in earlier chapters. Since consideration of rotational motion does not apply to a particle, only the conditions for translational equilibrium (Eq. 6.30 a) apply to a particle. Thus, for equilibrium of a particle the vector sum of all the forces on it must be zero. Since all these forces act on the single particle, they must be concurrent. Equilibrium under concurrent forces was discussed in the earlier chapters.

A body may be in partial equilibrium, i.e., it may be in translational equilibrium and not in rotational equilibrium, or it may be in rotational equilibrium and not in translational equilibrium.

Consider a light (i.e. of negligible mass) rod (AB) as shown in Fig. 6.20(a). At the two ends (A and B) of which two parallel forces, both equal in magnitude and acting along same direction are applied perpendicular to the rod.

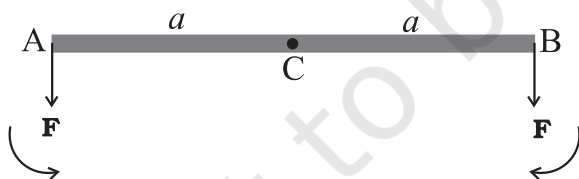

Fig. 6.20 (a)

Let C be the midpoint of AB, $CA = CB = a$. the moment of the forces at A and B will both be equal in magnitude (aF), but opposite in sense as shown. The net moment on the rod will be zero. The system will be in rotational equilibrium, but it will not be in translational equilibrium; $\sum \mathbf{F} \neq \mathbf{0}$

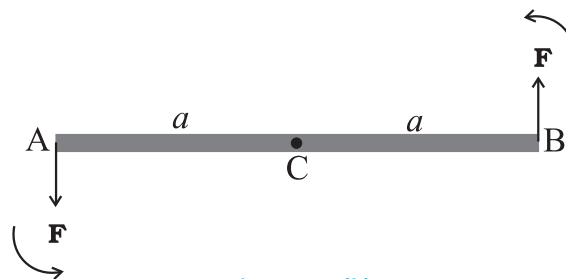

Fig. 6.20 (b)

The force at B in Fig. 6.20(a) is reversed in Fig. 6.20(b). Thus, we have the same rod with two forces of equal magnitude but acting in opposite directions applied perpendicular to the rod, one at end A and the other at end B. Here the moments of both the forces are equal, but they are not opposite; they act in the same sense and cause anticlockwise rotation of the rod. The total force on the body is zero; so the body is in translational equilibrium; but it is not in rotational equilibrium. Although the rod is not fixed in any way, it undergoes pure rotation (i.e. rotation without translation).

A pair of forces of equal magnitude but acting in opposite directions with different lines of action is known as a **couple** or **torque**. A couple produces rotation without translation.

When we open the lid of a bottle by turning it, our fingers are applying a couple to the lid [Fig. 6.21(a)]. Another known example is a compass needle in the earth's magnetic field as shown in the Fig. 6.21(b). The earth's magnetic field exerts equal forces on the north and south poles. The force on the North Pole is towards the north, and the force on the South Pole is toward the south. Except when the needle points in the north-south direction; the two forces do not have the same line of action. Thus there is a **couple** acting on the needle due to the earth's magnetic field.



Fig. 6.21(a) Our fingers apply a couple to turn the lid.

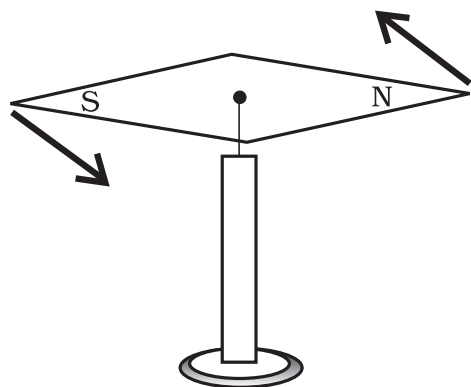

Fig. 6.21(b) The Earth's magnetic field exerts equal and opposite forces on the poles of a compass needle. These two forces form a couple.

▶ Example 6.7 Show that moment of a couple does not depend on the point about which you take the moments.

Answer

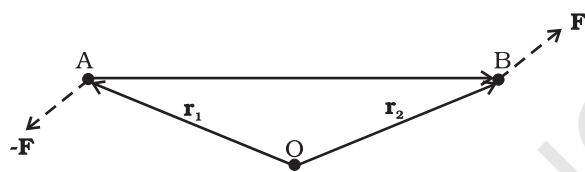

Fig. 6.22

Consider a couple as shown in Fig. 6.22 acting on a rigid body. The forces \mathbf{F} and $-\mathbf{F}$ act respectively at points B and A. These points have position vectors \mathbf{r}_1 and \mathbf{r}_2 with respect to origin O. Let us take the moments of the forces about the origin.

The moment of the couple = sum of the moments of the two forces making the couple

$$\begin{aligned} &= \mathbf{r}_1 \times (-\mathbf{F}) + \mathbf{r}_2 \times \mathbf{F} \\ &= \mathbf{r}_2 \times \mathbf{F} - \mathbf{r}_1 \times \mathbf{F} \\ &= (\mathbf{r}_2 - \mathbf{r}_1) \times \mathbf{F} \end{aligned}$$

But $\mathbf{r}_1 + \mathbf{AB} = \mathbf{r}_2$, and hence $\mathbf{AB} = \mathbf{r}_2 - \mathbf{r}_1$.

The moment of the couple, therefore, is $\mathbf{AB} \times \mathbf{F}$.

Clearly this is independent of the origin, the point about which we took the moments of the forces. ◀

6.8.1 Principle of moments

An ideal lever is essentially a light (i.e. of negligible mass) rod pivoted at a point along its

length. This point is called the fulcrum. A see-saw on the children's playground is a typical example of a lever. Two forces F_1 and F_2 , parallel to each other and usually perpendicular to the lever, as shown here, act on the lever at distances d_1 and d_2 respectively from the fulcrum as shown in Fig. 6.23.

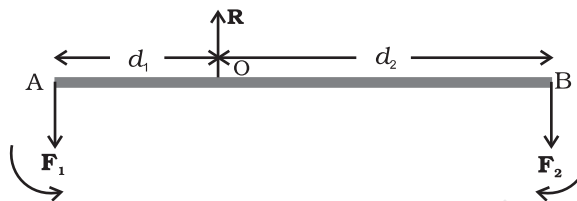

Fig. 6.23

The lever is a system in mechanical equilibrium. Let \mathbf{R} be the reaction of the support at the fulcrum; \mathbf{R} is directed opposite to the forces F_1 and F_2 . For translational equilibrium,

$$R - F_1 - F_2 = 0 \tag{i}$$

For considering rotational equilibrium we take the moments about the fulcrum; the sum of moments must be zero,

$$d_1 F_1 - d_2 F_2 = 0 \tag{ii}$$

Normally the anticlockwise (clockwise) moments are taken to be positive (negative). Note R acts at the fulcrum itself and has zero moment about the fulcrum.

In the case of the lever force F_1 is usually some weight to be lifted. It is called the *load* and its distance from the fulcrum d_1 is called the *load arm*. Force F_2 is the *effort* applied to lift the load; distance d_2 of the effort from the fulcrum is the *effort arm*.

Eq. (ii) can be written as

$$d_1 F_1 = d_2 F_2 \tag{6.32a}$$

or load arm \times load = effort arm \times effort

The above equation expresses the principle of moments for a lever. Incidentally the ratio F_1/F_2 is called the Mechanical Advantage (M.A.);

$$\text{M.A.} = \frac{F_1}{F_2} = \frac{d_2}{d_1} \tag{6.32b}$$

If the effort arm d_2 is larger than the load arm, the mechanical advantage is greater than one. Mechanical advantage greater than one means that a small effort can be used to lift a large load. There are several examples of a lever around you besides the see-saw. The beam of a balance is a lever. Try to find more such

examples and identify the fulcrum, the effort and effort arm, and the load and the load arm of the lever in each case.

You may easily show that the principle of moment holds even when the parallel forces F_1 and F_2 are not perpendicular, but act at some angle, to the lever.

6.8.2 Centre of gravity

Many of you may have the experience of balancing your notebook on the tip of a finger. Figure 6.24 illustrates a similar experiment that you can easily perform. Take an irregular-shaped cardboard having mass M and a narrow tipped object like a pencil. You can locate by trial and error a point G on the cardboard where it can be balanced on the tip of the pencil. (The cardboard remains horizontal in this position.) This point of balance is the centre of gravity (CG) of the cardboard. The tip of the pencil provides a vertically upward force due to which the cardboard is in mechanical equilibrium. As shown in the Fig. 6.24, the reaction of the tip is equal and opposite to $M\mathbf{g}$ and hence the cardboard is in translational equilibrium. It is also in rotational equilibrium; if it were not so, due to the unbalanced torque it would tilt and fall. There are torques on the cardboard due to the forces of gravity like $m_1\mathbf{g}$, $m_2\mathbf{g}$ etc, acting on the individual particles that make up the cardboard.

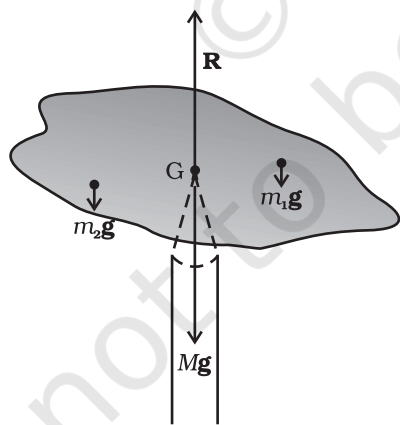

Fig. 6.24 Balancing a cardboard on the tip of a pencil. The point of support, G , is the centre of gravity.

The CG of the cardboard is so located that the total torque on it due to the forces $m_1\mathbf{g}$, $m_2\mathbf{g}$ etc. is zero.

If \mathbf{r}_i is the position vector of the i th particle of an extended body with respect to its CG, then the torque about the CG, due to the force of gravity on the particle is $\boldsymbol{\tau}_i = \mathbf{r}_i \times m_i\mathbf{g}$. The total gravitational torque about the CG is zero, i.e.

$$\boldsymbol{\tau}_g = \sum \boldsymbol{\tau}_i = \sum \mathbf{r}_i \times m_i\mathbf{g} = \mathbf{0} \quad (6.33)$$

We may therefore, define the CG of a body as that point where the total gravitational torque on the body is zero.

We notice that in Eq. (6.33), \mathbf{g} is the same for all particles, and hence it comes out of the summation. This gives, since \mathbf{g} is non-zero, $\sum m_i\mathbf{r}_i = \mathbf{0}$. Remember that the position vectors (\mathbf{r}) are taken with respect to the CG. Now, in accordance with the reasoning given below Eq. (6.4a) in Sec. 6.2, if the sum is zero, the origin must be the centre of mass of the body. Thus, the centre of gravity of the body coincides with the centre of mass in uniform gravity or gravity-

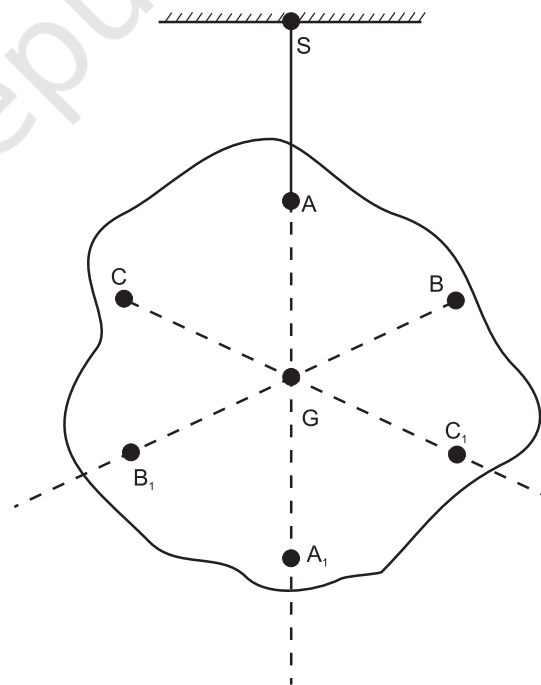

Fig. 6.25 Determining the centre of gravity of a body of irregular shape. The centre of gravity G lies on the vertical AA_1 through the point of suspension of the body A .

free space. We note that this is true because the body being small, g does not vary from one point of the body to the other. If the body is so extended that g varies from part to part of the body, then the centre of gravity and centre of mass will not coincide. Basically, the two are different concepts. The centre of mass has nothing to do with gravity. It depends only on the distribution of mass of the body.

In Sec. 6.2 we found out the position of the centre of mass of several regular, homogeneous objects. Obviously the method used there gives us also the centre of gravity of these bodies, if they are small enough.

Figure 6.25 illustrates another way of determining the CG of an irregular shaped body like a cardboard. If you suspend the body from some point like A, the vertical line through A passes through the CG. We mark the vertical AA_1 . We then suspend the body through other points like B and C. The intersection of the verticals gives the CG. Explain why the method works. Since the body is small enough, the method allows us to determine also its centre of mass.

► **Example 6.8** A metal bar 70 cm long and 4.00 kg in mass supported on two knife-edges placed 10 cm from each end. A 6.00 kg load is suspended at 30 cm from one end. Find the reactions at the knife-edges. (Assume the bar to be of uniform cross section and homogeneous.)

Answer

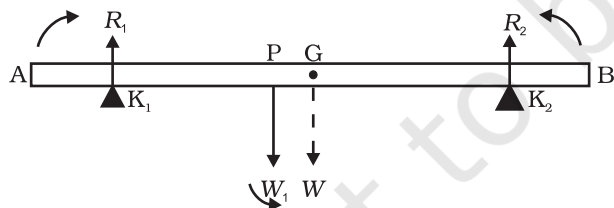

Fig. 6.26

Figure 6.26 shows the rod AB, the positions of the knife edges K_1 and K_2 , the centre of gravity of the rod at G and the suspended load at P.

Note the weight of the rod W acts at its centre of gravity G. The rod is uniform in cross section and homogeneous; hence G is at the centre of the rod; $AB = 70$ cm. $AG = 35$ cm, AP

$= 30$ cm, $PG = 5$ cm, $AK_1 = BK_2 = 10$ cm and $K_1G = K_2G = 25$ cm. Also, $W =$ weight of the rod $= 4.00$ kg and $W_1 =$ suspended load $= 6.00$ kg; R_1 and R_2 are the normal reactions of the support at the knife edges.

For translational equilibrium of the rod,

$$R_1 + R_2 - W_1 - W = 0 \tag{i}$$

Note W_1 and W act vertically down and R_1 and R_2 act vertically up.

For considering rotational equilibrium, we take moments of the forces. A convenient point to take moments about is G. The moments of R_2 and W_1 are anticlockwise (+ve), whereas the moment of R_1 is clockwise (-ve).

For rotational equilibrium,

$$-R_1 (K_1G) + W_1 (PG) + R_2 (K_2G) = 0 \tag{ii}$$

It is given that $W = 4.00g$ N and $W_1 = 6.00g$ N, where $g =$ acceleration due to gravity. We take $g = 9.8$ m/s².

With numerical values inserted, from (i)

$$\begin{aligned} R_1 + R_2 - 4.00g - 6.00g &= 0 \\ \text{or } R_1 + R_2 &= 10.00g \text{ N} \tag{iii} \\ &= 98.00 \text{ N} \end{aligned}$$

$$\begin{aligned} \text{From (ii), } -0.25 R_1 + 0.05 W_1 + 0.25 R_2 &= 0 \\ \text{or } R_1 - R_2 &= 1.2g \text{ N} = 11.76 \text{ N} \tag{iv} \end{aligned}$$

From (iii) and (iv), $R_1 = 54.88$ N,

$$R_2 = 43.12 \text{ N}$$

Thus the reactions of the support are about 55 N at K_1 and 43 N at K_2 . ◀

► **Example 6.9** A 3m long ladder weighing 20 kg leans on a frictionless wall. Its feet rest on the floor 1 m from the wall as shown in Fig.6.27. Find the reaction forces of the wall and the floor.

Answer

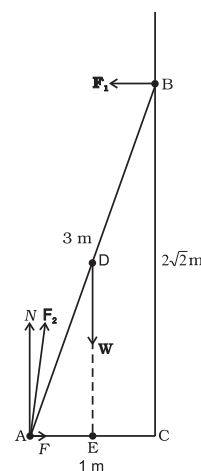

Fig. 6.27

The ladder AB is 3 m long, its foot A is at distance AC = 1 m from the wall. From Pythagoras theorem, BC = $2\sqrt{2}$ m. The forces on the ladder are its weight W acting at its centre of gravity D, reaction forces F_1 and F_2 of the wall and the floor respectively. Force F_1 is perpendicular to the wall, since the wall is frictionless. Force F_2 is resolved into two components, the normal reaction N and the force of friction F . Note that F prevents the ladder from sliding away from the wall and is therefore directed toward the wall.

For translational equilibrium, taking the forces in the vertical direction,

$$N - W = 0 \quad \text{(i)}$$

Taking the forces in the horizontal direction,

$$F - F_1 = 0 \quad \text{(ii)}$$

For rotational equilibrium, taking the moments of the forces about A,

$$2\sqrt{2}F_1 - (1/2)W = 0 \quad \text{(iii)}$$

Now $W = 20 \text{ g} = 20 \times 9.8 \text{ N} = 196.0 \text{ N}$

From (i) $N = 196.0 \text{ N}$

From (iii) $F_1 = W/4\sqrt{2} = 196.0/4\sqrt{2} = 34.6 \text{ N}$

From (ii) $F = F_1 = 34.6 \text{ N}$

$$F_2 = \sqrt{F^2 + N^2} = 199.0 \text{ N}$$

The force F_2 makes an angle α with the horizontal,

$$\tan \alpha = N/F = 4\sqrt{2}, \quad \alpha = \tan^{-1}(4\sqrt{2}) \approx 80^\circ \quad \blacktriangleleft$$

6.9 MOMENT OF INERTIA

We have already mentioned that we are developing the study of rotational motion parallel to the study of translational motion with which we are familiar. We have yet to answer one major question in this connection. **What is the analogue of mass in rotational motion?** We shall attempt to answer this question in the present section. To keep the discussion simple, we shall consider rotation about a fixed axis only. Let us try to get an expression for **the kinetic energy of a rotating body**. We know that for a body rotating about a fixed axis, each particle of the body moves in a circle with linear velocity given by Eq. (6.19). (Refer to Fig. 6.16). For a particle at a distance

from the axis, the linear velocity is $v_i = r_i\omega$. The kinetic energy of motion of this particle is

$$k_i = \frac{1}{2}m_i v_i^2 = \frac{1}{2}m_i r_i^2 \omega^2$$

where m_i is the mass of the particle. The total kinetic energy K of the body is then given by the sum of the kinetic energies of individual particles,

$$K = \sum_{i=1}^n k_i = \frac{1}{2} \sum_{i=1}^n (m_i r_i^2 \omega^2)$$

Here n is the number of particles in the body. Note ω is the same for all particles. Hence, taking ω out of the sum,

$$K = \frac{1}{2} \omega^2 \left(\sum_{i=1}^n m_i r_i^2 \right)$$

We define a new parameter characterising the rigid body, called the moment of inertia I , given by

$$I = \sum_{i=1}^n m_i r_i^2 \quad \text{(6.34)}$$

With this definition,

$$K = \frac{1}{2} I \omega^2 \quad \text{(6.35)}$$

Note that the parameter I is independent of the magnitude of the angular velocity. It is a characteristic of the rigid body and the axis about which it rotates.

Compare Eq. (6.35) for the kinetic energy of a rotating body with the expression for the kinetic energy of a body in linear (translational) motion,

$$K = \frac{1}{2} m v^2$$

Here, m is the mass of the body and v is its velocity. We have already noted the analogy between angular velocity ω (in respect of rotational motion about a fixed axis) and linear velocity v (in respect of linear motion). It is then evident that the parameter, moment of inertia I , is the desired rotational analogue of mass in linear motion. In rotation (about a fixed axis), the moment of inertia plays a similar role as mass does in linear motion.

We now apply the definition Eq. (6.34), to calculate the moment of inertia in two simple cases.

- (a) Consider a thin ring of radius R and mass M , rotating in its own plane around its centre with angular velocity ω . Each mass element of the ring is at a distance R from the axis, and moves with a speed $R\omega$. The kinetic energy is therefore,

$$K = \frac{1}{2} Mv^2 = \frac{1}{2} MR^2 \omega^2$$

Comparing with Eq. (6.35) we get $I = MR^2$ for the ring.

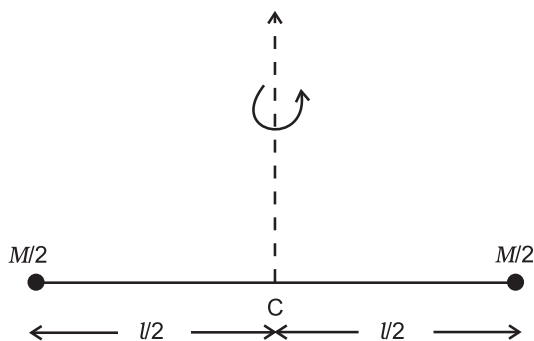

Fig. 6.28 A light rod of length l with a pair of masses rotating about an axis through the centre of mass of the system and perpendicular to the rod. The total mass of the system is M .

- (b) Next, take a rigid rod of negligible mass of length of length l with a pair of small masses, rotating about an axis through the centre of mass perpendicular to the rod (Fig. 6.28). Each mass $M/2$ is at a distance $l/2$ from the axis. The moment of inertia of the masses is therefore given by

$$(M/2)(l/2)^2 + (M/2)(l/2)^2$$

Thus, for the pair of masses, rotating about the axis through the centre of mass perpendicular to the rod

$$I = MI^2 / 4$$

Table 6.1 simply gives the moment of inertia of various familiar regular shaped bodies about specific axes. (The derivations of these expressions are beyond the scope of this textbook and you will study them in higher classes.)

As the mass of a body resists a change in its state of linear motion, it is a measure of its inertia in linear motion. Similarly, as the moment of inertia about a given axis of rotation resists a

change in its rotational motion, it can be regarded as a measure of rotational inertia of the body; it is a measure of the way in which different parts of the body are distributed at different distances from the axis. Unlike the mass of a body, the moment of inertia is not a fixed quantity but depends on distribution of mass about the axis of rotation, and the orientation and position of the axis of rotation with respect to the body as a whole. As a measure of the way in which the mass of a rotating rigid body is distributed with respect to the axis of rotation, we can define a new parameter, the **radius of gyration**. It is related to the moment of inertia and the total mass of the body.







Notice from the Table 6.1 that in all cases, we can write $I = Mk^2$, where k has the dimension of length. For a rod, about the perpendicular axis at its midpoint, $k^2 = L^2/12$, i.e. $k = L/\sqrt{12}$. Similarly, $k = R/2$ for the circular disc about its diameter. The length k is a geometric property of the body and axis of rotation. It is called the **radius of gyration**. **The radius of gyration of a body about an axis** may be defined as the distance from the axis of a mass point whose mass is equal to the mass of the whole body and whose moment of inertia is equal to the moment of inertia of the body about the axis.

Thus, the moment of inertia of a rigid body depends on the mass of the body, its shape and size; distribution of mass about the axis of rotation, and the position and orientation of the axis of rotation.

From the definition, Eq. (6.34), we can infer that the dimensions of moments of inertia are ML^2 and its SI units are $kg\ m^2$.

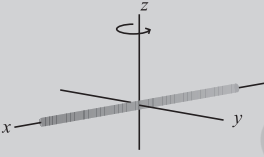
The property of this extremely important quantity I , as a measure of rotational inertia of the body, has been put to a great practical use. The machines, such as steam engine and the automobile engine, etc., that produce rotational motion have a disc with a large moment of inertia, called a **flywheel**. Because of its large moment of inertia, the flywheel resists the sudden increase or decrease of the speed of the vehicle. It allows a gradual change in the speed and prevents jerky motions, thereby ensuring a smooth ride for the passengers on the vehicle.

Table 6.1 Moments of inertia of some regular shaped bodies about specific axes

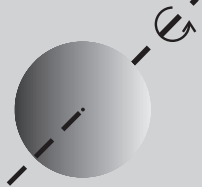
| Z | Body | Axis | Figure | I |
|-----|--------------------------------|------------------------------------|---|-----------|
| (1) | Thin circular ring, radius R | Perpendicular to plane, at centre |  | MR^2 |
| (2) | Thin circular ring, radius R | Diameter |  | $MR^2/2$ |
| (3) | Thin rod, length L | Perpendicular to rod, at mid point |  | $ML^2/12$ |
| (4) | Circular disc, radius R | Perpendicular to disc at centre |  | $MR^2/2$ |
| (5) | Circular disc, radius R | Diameter |  | $MR^2/4$ |
| (6) | Hollow cylinder, radius R | Axis of cylinder |  | MR^2 |
| (7) | Solid cylinder, radius R | Axis of cylinder |  | $MR^2/2$ |
| (8) | Solid sphere, radius R | Diameter |  | $2MR^2/5$ |

6.10 KINEMATICS OF ROTATIONAL MOTION ABOUT A FIXED AXIS

We have already indicated the analogy between rotational motion and translational motion. For example, the angular velocity ω plays the same role in rotation as the linear velocity \mathbf{v} in

translation. We wish to take this analogy further. In doing so we shall restrict the discussion only to rotation about fixed axis. This case of motion involves only one degree of freedom, i.e., needs only one independent variable to describe the motion. This in translation corresponds to linear

motion. This section is limited only to kinematics. We shall turn to dynamics in later sections.

We recall that for specifying the angular displacement of the rotating body we take any particle like P (Fig.6.29) of the body. Its angular displacement θ in the plane it moves is the angular displacement of the whole body; θ is measured from a fixed direction in the plane of motion of P, which we take to be the x' -axis, chosen parallel to the x -axis. Note, as shown, the axis of rotation is the z -axis and the plane of the motion of the particle is the $x - y$ plane. Fig. 6.29 also shows θ_0 , the angular displacement at $t = 0$.

We also recall that the angular velocity is the time rate of change of angular displacement, $\omega = d\theta/dt$. Note since the axis of rotation is fixed, there is no need to treat angular velocity as a vector. Further, the angular acceleration, $\alpha = d\omega/dt$.

The kinematical quantities in rotational motion, angular displacement (θ), angular velocity (ω) and angular acceleration (α) respectively are analogous to kinematic quantities in linear motion, displacement (x), velocity (v) and acceleration (a). We know the kinematical equations of linear motion with uniform (i.e. constant) acceleration:

$$v = v_0 + at \tag{a}$$

$$x = x_0 + v_0t + \frac{1}{2}at^2 \tag{b}$$

$$v^2 = v_0^2 + 2ax \tag{c}$$

where x_0 = initial displacement and v_0 = initial velocity. The word 'initial' refers to values of the quantities at $t = 0$

The corresponding kinematic equations for rotational motion with uniform angular acceleration are:

$$\omega = \omega_0 + \alpha t \tag{6.36}$$

$$\theta = \theta_0 + \omega_0t + \frac{1}{2}\alpha t^2 \tag{6.37}$$

$$\text{and } \omega^2 = \omega_0^2 + 2\alpha(\theta - \theta_0) \tag{6.38}$$

where θ_0 = initial angular displacement of the rotating body, and ω_0 = initial angular velocity of the body.

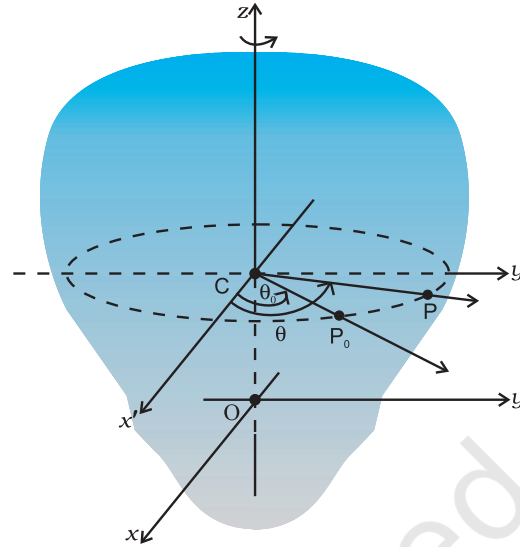

Fig. 6.29 Specifying the angular position of a rigid body.

► **Example 6.10** Obtain Eq. (6.36) from first principles.

Answer The angular acceleration is uniform, hence

$$\frac{d\omega}{dt} = \alpha = \text{constant} \tag{i}$$

Integrating this equation,

$$\begin{aligned} \omega &= \int \alpha dt + c \\ &= \alpha t + c \quad (\text{as } \alpha \text{ is constant}) \end{aligned}$$

At $t = 0$, $\omega = \omega_0$ (given)

From (i) we get at $t = 0$, $\omega = c = \omega_0$

Thus, $\omega = \alpha t + \omega_0$ as required.

With the definition of $\omega = d\theta/dt$ we may integrate Eq. (6.36) to get Eq. (6.37). This derivation and the derivation of Eq. (6.38) is left as an exercise.

► **Example 6.11** The angular speed of a motor wheel is increased from 1200 rpm to 3120 rpm in 16 seconds. (i) What is its angular acceleration, assuming the acceleration to be uniform? (ii) How many revolutions does the engine make during this time?

Answer

(i) We shall use $\omega = \omega_0 + \alpha t$

ω_0 = initial angular speed in rad/s

$$\begin{aligned}
 &= 2\pi \times \text{angular speed in rev/s} \\
 &= \frac{2\pi \times \text{angular speed in rev/min}}{60 \text{ s/min}} \\
 &= \frac{2\pi \times 1200}{60} \text{ rad/s} \\
 &= 40\pi \text{ rad/s}
 \end{aligned}$$

Similarly $\omega =$ final angular speed in rad/s

$$\begin{aligned}
 &= \frac{2\pi \times 3120}{60} \text{ rad/s} \\
 &= 2\pi \times 52 \text{ rad/s} \\
 &= 104\pi \text{ rad/s}
 \end{aligned}$$

\therefore Angular acceleration

$$\alpha = \frac{\omega - \omega_0}{t} = 4\pi \text{ rad/s}^2$$

The angular acceleration of the engine
 $= 4\pi \text{ rad/s}^2$

(ii) The angular displacement in time t is given by

$$\begin{aligned}
 \theta &= \omega_0 t + \frac{1}{2} \alpha t^2 \\
 &= (40\pi \times 16 + \frac{1}{2} \times 4\pi \times 16^2) \text{ rad} \\
 &= (640\pi + 512\pi) \text{ rad} \\
 &= 1152\pi \text{ rad}
 \end{aligned}$$

$$\text{Number of revolutions} = \frac{1152\pi}{2\pi} = 576 \quad \blacktriangleleft$$

6.11 DYNAMICS OF ROTATIONAL MOTION ABOUT A FIXED AXIS

Table 6.2 lists quantities associated with linear motion and their analogues in rotational motion. We have already compared kinematics of the two motions. Also, we know that in rotational motion moment of inertia and torque play the same role as mass and force respectively in linear motion. Given this we should be able to guess what the other analogues indicated in the table are. For example, we know that in linear motion, work done is given by $F dx$, in rotational motion about a fixed axis it should be $\tau d\theta$, since we already know the correspondence $dx \rightarrow d\theta$ and $F \rightarrow \tau$.

It is, however, necessary that these correspondences are established on sound dynamical considerations. This is what we now turn to.

Before we begin, we note a **simplification that arises in the case of rotational motion about a fixed axis**. Since the axis is fixed, only those components of torques, which are along the direction of the fixed axis need to be considered in our discussion. Only these components can cause the body to rotate about the axis. A component of the torque perpendicular to the axis of rotation will tend to turn the axis from its position. We specifically assume that there will arise necessary forces of constraint to cancel the effect of the perpendicular components of the (external) torques, so that the fixed position of the axis will be maintained. The perpendicular components of the torques, therefore need not be taken into account. This means that for our calculation of torques on a rigid body:

- (1) We need to consider only those forces that lie in planes perpendicular to the axis. Forces which are parallel to the axis will give torques perpendicular to the axis and need not be taken into account.
- (2) We need to consider only those components of the position vectors which are perpendicular to the axis. Components of position vectors along the axis will result in torques perpendicular to the axis and need not be taken into account.

Work done by a torque

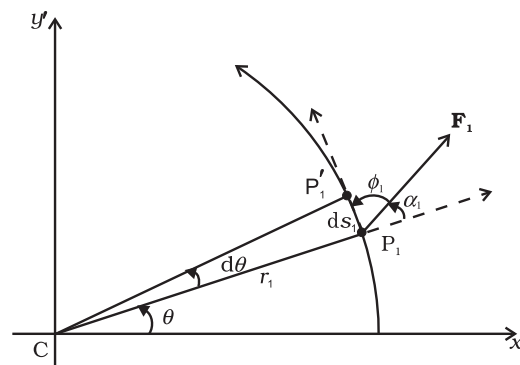

Fig. 6.30 Work done by a force \mathbf{F}_1 acting on a particle of a body rotating about a fixed axis; the particle describes a circular path with centre C on the axis; arc P_1P_1' (ds_1) gives the displacement of the particle.

Table 6.2 Comparison of Translational and Rotational Motion

| Linear Motion | Rotational Motion about a Fixed Axis |
|-------------------------------|--|
| 1 Displacement x | Angular displacement θ |
| 2 Velocity $v = dx/dt$ | Angular velocity $\omega = d\theta/dt$ |
| 3 Acceleration $a = dv/dt$ | Angular acceleration $\alpha = d\omega/dt$ |
| 4 Mass M | Moment of inertia I |
| 5 Force $F = Ma$ | Torque $\tau = I\alpha$ |
| 6 Work $dW = F ds$ | Work $W = \tau d\theta$ |
| 7 Kinetic energy $K = Mv^2/2$ | Kinetic energy $K = I\omega^2/2$ |
| 8 Power $P = Fv$ | Power $P = \tau\omega$ |
| 9 Linear momentum $p = Mv$ | Angular momentum $L = I\omega$ |

Figure 6.30 shows a cross-section of a rigid body rotating about a fixed axis, which is taken as the z -axis (perpendicular to the plane of the page; see Fig. 6.29). As said above we need to consider only those forces which lie in planes perpendicular to the axis. Let \mathbf{F}_1 be one such typical force acting as shown on a particle of the body at point P_1 with its line of action in a plane perpendicular to the axis. For convenience we call this to be the x' - y' plane (coincident with the plane of the page). The particle at P_1 describes a circular path of radius r_1 with centre C on the axis; $CP_1 = r_1$.

In time Δt , the point moves to the position P_1' . The displacement of the particle $d\mathbf{s}_1$, therefore, has magnitude $ds_1 = r_1 d\theta$ and direction tangential at P_1 to the circular path as shown. Here $d\theta$ is the angular displacement of the particle, $d\theta = \angle P_1CP_1'$. The work done by the force on the particle is

$$dW_1 = \mathbf{F}_1 \cdot d\mathbf{s}_1 = F_1 ds_1 \cos\phi_1 = F_1 (r_1 d\theta) \sin\alpha_1$$

where ϕ_1 is the angle between \mathbf{F}_1 and the tangent at P_1 , and α_1 is the angle between \mathbf{F}_1 and the radius vector \mathbf{OP}_1 ; $\phi_1 + \alpha_1 = 90^\circ$.

The torque due to \mathbf{F}_1 about the origin is $\mathbf{OP}_1 \times \mathbf{F}_1$. Now $\mathbf{OP}_1 = \mathbf{OC} + \mathbf{CP}_1$. [Refer to Fig. 6.17(b).] Since \mathbf{OC} is along the axis, the torque resulting from it is excluded from our consideration. The effective torque due to \mathbf{F}_1 is $\boldsymbol{\tau}_1 = \mathbf{CP}_1 \times \mathbf{F}_1$; it is directed along the axis of rotation and has a magnitude $\tau_1 = r_1 F_1 \sin\alpha$. Therefore,

$$dW_1 = \tau_1 d\theta$$

If there are more than one forces acting on the body, the work done by all of them can be added to give the total work done on the body. Denoting the magnitudes of the torques due to the different forces as τ_1, τ_2, \dots etc,

$$dW = (\tau_1 + \tau_2 + \dots) d\theta$$

Remember, the forces giving rise to the torques act on different particles, but the angular displacement $d\theta$ is the same for all particles. Since all the torques considered are parallel to the fixed axis, the magnitude τ of the total torque is just the algebraic sum of the magnitudes of the torques, i.e., $\tau = \tau_1 + \tau_2 + \dots$. We, therefore, have

$$dW = \tau d\theta \quad (6.39)$$

This expression gives the work done by the total (external) torque τ which acts on the body rotating about a fixed axis. Its similarity with the corresponding expression

$$dW = F ds$$

for linear (translational) motion is obvious.

Dividing both sides of Eq. (6.39) by dt gives

$$P = \frac{dW}{dt} = \tau \frac{d\theta}{dt} = \tau\omega$$

$$\text{or } P = \tau\omega \quad (6.40)$$

This is the instantaneous power. Compare this expression for power in the case of rotational motion about a fixed axis with that of power in the case of linear motion,

$$P = Fv$$

In a perfectly rigid body there is no internal motion. The work done by external torques is

therefore, not dissipated and goes on to increase the kinetic energy of the body. The rate at which work is done on the body is given by Eq. (6.40). This is to be equated to the rate at which kinetic energy increases. The rate of increase of kinetic energy is

$$\frac{d}{dt} \left(\frac{I\omega^2}{2} \right) = I \frac{(2\omega) d\omega}{2 dt}$$

We assume that the moment of inertia does not change with time. This means that the mass of the body does not change, the body remains rigid and also the axis does not change its position with respect to the body.

Since $\alpha = d\omega/dt$, we get

$$\frac{d}{dt} \left(\frac{I\omega^2}{2} \right) = I\omega\alpha$$

Equating rates of work done and of increase in kinetic energy,

$$\tau\omega = I\omega\alpha$$

$$\tau = I\alpha \quad (6.41)$$

Eq. (6.41) is similar to Newton's second law for linear motion expressed symbolically as

$$F = ma$$

Just as force produces acceleration, torque produces angular acceleration in a body. The angular acceleration is directly proportional to the applied torque and is inversely proportional to the moment of inertia of the body. In this respect, Eq.(6.41) can be called Newton's second law for rotational motion about a fixed axis.

Example 6.12 A cord of negligible mass is wound round the rim of a fly wheel of mass 20 kg and radius 20 cm. A steady pull of 25 N is applied on the cord as shown in Fig. 6.31. The flywheel is mounted on a horizontal axle with frictionless bearings.

- Compute the angular acceleration of the wheel.
- Find the work done by the pull, when 2m of the cord is unwound.
- Find also the kinetic energy of the wheel at this point. Assume that the wheel starts from rest.
- Compare answers to parts (b) and (c).

Answer

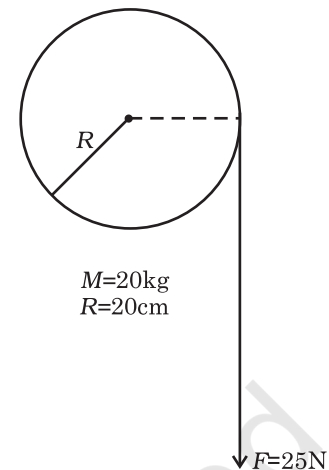

Fig. 6.31

- We use $I\alpha = \tau$
the torque $\tau = FR$
 $= 25 \times 0.20 \text{ Nm}$ (as $R = 0.20\text{m}$)
 $= 5.0 \text{ Nm}$

$I =$ Moment of inertia of flywheel about its

$$\text{axis} = \frac{MR^2}{2}$$

$$= \frac{20.0 \times (0.2)^2}{2} = 0.4 \text{ kg m}^2$$

$\alpha =$ angular acceleration

$$= 5.0 \text{ N m} / 0.4 \text{ kg m}^2 = 12.5 \text{ s}^{-2}$$

- Work done by the pull unwinding 2m of the cord
 $= 25 \text{ N} \times 2\text{m} = 50 \text{ J}$
- Let ω be the final angular velocity. The

$$\text{kinetic energy gained} = \frac{1}{2} I\omega^2,$$

since the wheel starts from rest. Now,

$$\omega^2 = \omega_0^2 + 2\alpha\theta, \quad \omega_0 = 0$$

The angular displacement $\theta =$ length of unwound string / radius of wheel
 $= 2\text{m} / 0.2 \text{ m} = 10 \text{ rad}$

$$\omega^2 = 2 \times 12.5 \times 10.0 = 250 \text{ (rad/s)}^2$$

$$\therefore \text{K.E. gained} = \frac{1}{2} \times 0.4 \times 250 = 50 \text{ J}$$

- The answers are the same, i.e. the kinetic energy gained by the wheel = work done by the force. There is no loss of energy due to friction. ◀

6.12 ANGULAR MOMENTUM IN CASE OF ROTATION ABOUT A FIXED AXIS

We have studied in section 6.7, the angular momentum of a system of particles. We already know from there that the time rate of total angular momentum of a system of particles about a point is equal to the total external torque on the system taken about the same point. When the total external torque is zero, the total angular momentum of the system is conserved.

We now wish to study the angular momentum in the special case of rotation about a fixed axis. The general expression for the total angular momentum of the system of n particles is

$$\mathbf{L} = \sum_{i=1}^N \mathbf{r}_i \times \mathbf{p}_i \quad (6.25b)$$

We first consider the angular momentum of a typical particle of the rotating rigid body. We then sum up the contributions of individual particles to get \mathbf{L} of the whole body.

For a typical particle $l = \mathbf{r} \times \mathbf{p}$. As seen in the last section $\mathbf{r} = \mathbf{OP} = \mathbf{OC} + \mathbf{CP}$ [Fig. 6.17(b)]. With $\mathbf{p} = m \mathbf{v}$,

$$l = (\mathbf{OC} \times m \mathbf{v}) + (\mathbf{CP} \times m \mathbf{v})$$

The magnitude of the linear velocity \mathbf{v} of the particle at P is given by $v = \omega r_{\perp}$ where r_{\perp} is the length of CP or the perpendicular distance of P from the axis of rotation. Further, \mathbf{v} is tangential at P to the circle which the particle describes. Using the right-hand rule one can check that $\mathbf{CP} \times \mathbf{v}$ is parallel to the fixed axis. The unit vector along the fixed axis (chosen as the z -axis) is $\hat{\mathbf{k}}$. Hence

$$\begin{aligned} \mathbf{CP} \times m \mathbf{v} &= r_{\perp} (m v) \hat{\mathbf{k}} \\ &= m r_{\perp}^2 \omega \hat{\mathbf{k}} \quad (\text{since } v = \omega r_{\perp}) \end{aligned}$$

Similarly, we can check that $\mathbf{OC} \times \mathbf{v}$ is perpendicular to the fixed axis. Let us denote the part of l along the fixed axis (i.e. the z -axis) by l_z , then

$$l_z = \mathbf{CP} \times m \mathbf{v} = m r_{\perp}^2 \omega \hat{\mathbf{k}}$$

and $l = l_z + \mathbf{OC} \times m \mathbf{v}$

We note that l_z is parallel to the fixed axis, but l is not. In general, for a particle, the angular momentum l is not along the axis of rotation, i.e. for a particle, l and ω are not necessarily parallel. Compare this with the corresponding fact in translation. For a particle, \mathbf{p} and \mathbf{v} are always parallel to each other.

For computing the total angular momentum of the whole rigid body, we add up the contribution of each particle of the body.

$$\text{Thus } \mathbf{L} = \sum \mathbf{l}_i = \sum l_{iz} + \sum \mathbf{OC}_i \times m_i \mathbf{v}_i$$

We denote by \mathbf{L}_{\perp} and \mathbf{L}_z the components of \mathbf{L} respectively perpendicular to the z -axis and along the z -axis;

$$\mathbf{L}_{\perp} = \sum \mathbf{OC}_i \times m_i \mathbf{v}_i \quad (6.42a)$$

where m_i and \mathbf{v}_i are respectively the mass and the velocity of the i^{th} particle and C_i is the centre of the circle described by the particle;

$$\text{and } \mathbf{L}_z = \sum l_{iz} = \left(\sum_i m_i r_i^2 \right) \omega \hat{\mathbf{k}}$$

$$\text{or } \mathbf{L}_z = I \omega \hat{\mathbf{k}} \quad (6.42b)$$

The last step follows since the perpendicular distance of the i^{th} particle from the axis is r_i ; and by definition the moment of inertia of the body about the axis of rotation is $I = \sum m_i r_i^2$.

$$\text{Note } \mathbf{L} = \mathbf{L}_z + \mathbf{L}_{\perp} \quad (6.42c)$$

The rigid bodies which we have mainly considered in this chapter are symmetric about the axis of rotation, i.e. the axis of rotation is one of their symmetry axes. For such bodies, for a given \mathbf{OC}_i , for every particle which has a velocity \mathbf{v}_i , there is another particle of velocity $-\mathbf{v}_i$ located diametrically opposite on the circle with centre C_i described by the particle. Together such pairs will contribute zero to \mathbf{L}_{\perp} and as a result for symmetric bodies \mathbf{L}_{\perp} is zero, and hence

$$\mathbf{L} = \mathbf{L}_z = I \omega \hat{\mathbf{k}} \quad (6.42d)$$

For bodies, which are not symmetric about the axis of rotation, \mathbf{L} is not equal to \mathbf{L}_z and hence \mathbf{L} does not lie along the axis of rotation.

Referring to Table 6.1, can you tell in which cases $\mathbf{L} = \mathbf{L}_z$ will not apply?

Let us differentiate Eq. (6.42b). Since $\hat{\mathbf{k}}$ is a fixed (constant) vector, we get

$$\frac{d}{dt}(\mathbf{L}_z) = \left(\frac{d}{dt}(I\omega) \right) \hat{\mathbf{k}}$$

Now, Eq. (6.28b) states

$$\frac{d\mathbf{L}}{dt} = \boldsymbol{\tau}$$

As we have seen in the last section, only those components of the external torques which are along the axis of rotation, need to be taken into account, when we discuss rotation about a fixed axis. This means we can take $\boldsymbol{\tau} = \tau \hat{\mathbf{k}}$. Since $\mathbf{L} = \mathbf{L}_z + \mathbf{L}_\perp$ and the direction of \mathbf{L}_z (vector $\hat{\mathbf{k}}$) is fixed, it follows that for rotation about a fixed axis,

$$\frac{d\mathbf{L}_z}{dt} = \tau \hat{\mathbf{k}} \quad (6.43a)$$

$$\text{and } \frac{d\mathbf{L}_\perp}{dt} = 0 \quad (6.43b)$$

Thus, for rotation about a fixed axis, the component of angular momentum perpendicular to the fixed axis is constant. As $\mathbf{L}_z = I\omega \hat{\mathbf{k}}$, we get from Eq. (6.43a),

$$\frac{d}{dt}(I\omega) = \tau \quad (6.43c)$$

If the moment of inertia I does not change with time,

$$\frac{d}{dt}(I\omega) = I \frac{d\omega}{dt} = I\alpha$$

and we get from Eq. (6.43c),

$$\tau = I\alpha \quad (6.41)$$



Fig 6.32 (a) A demonstration of conservation of angular momentum. A girl sits on a swivel chair and stretches her arms/brings her arms closer to the body.

We have already derived this equation using the work - kinetic energy route.

6.12.1 Conservation of angular momentum

We are now in a position to revisit the principle of conservation of angular momentum in the context of rotation about a fixed axis. From Eq. (6.43c), if the external torque is zero,

$$L_z = I\omega = \text{constant} \quad (6.44)$$

For symmetric bodies, from Eq. (6.42d), L_z may be replaced by L . (L and L_z are respectively the magnitudes of \mathbf{L} and \mathbf{L}_z .)

This then is the required form, for fixed axis rotation, of Eq. (6.29a), which expresses the general law of conservation of angular momentum of a system of particles. Eq. (6.44) applies to many situations that we come across in daily life. You may do this experiment with your friend. Sit on a swivel chair (a chair with a seat, free to rotate about a pivot) with your arms folded and feet not resting on, i.e., away from, the ground. Ask your friend to rotate the chair rapidly. While the chair is rotating with considerable angular speed stretch your arms horizontally. What happens? Your angular speed is reduced. If you bring back your arms closer to your body, the angular speed increases again. This is a situation where the principle of conservation of angular momentum is applicable. If friction in the rotational

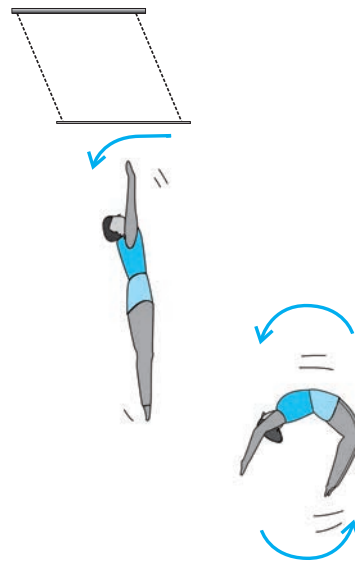

Fig 6.32 (b) An acrobat employing the principle of conservation of angular momentum in her performance.

mechanism is neglected, there is no external torque about the axis of rotation of the chair and hence $I\omega$ is constant. Stretching the arms increases I about the axis of rotation, resulting in decreasing the angular speed ω . Bringing the arms closer to the body has the opposite effect.

A circus acrobat and a diver take advantage of this principle. Also, skaters and classical, Indian or western, dancers performing a pirouette (a spinning about a tip-top) on the toes of one foot display 'mastery' over this principle. Can you explain?

SUMMARY

1. Ideally, a rigid body is one for which the distances between different particles of the body do not change, even though there are forces on them.
2. A rigid body fixed at one point or along a line can have only rotational motion. A rigid body not fixed in some way can have either pure translational motion or a combination of translational and rotational motions.
3. In rotation about a fixed axis, every particle of the rigid body moves in a circle which lies in a plane perpendicular to the axis and has its centre on the axis. Every Point in the rotating rigid body has the same angular velocity at any instant of time.
4. In pure translation, every particle of the body moves with the same velocity at any instant of time.
5. Angular velocity is a vector. Its magnitude is $\omega = d\theta/dt$ and it is directed along the axis of rotation. For rotation about a fixed axis, this vector $\boldsymbol{\omega}$ has a fixed direction.
6. The vector or cross product of two vector \mathbf{a} and \mathbf{b} is a vector written as $\mathbf{a} \times \mathbf{b}$. The magnitude of this vector is $ab\sin\theta$ and its direction is given by the right handed screw or the right hand rule.
7. The linear velocity of a particle of a rigid body rotating about a fixed axis is given by $\mathbf{v} = \boldsymbol{\omega} \times \mathbf{r}$, where \mathbf{r} is the position vector of the particle with respect to an origin along the fixed axis. The relation applies even to more general rotation of a rigid body with one point fixed. In that case \mathbf{r} is the position vector of the particle with respect to the fixed point taken as the origin.
8. The centre of mass of a system of n particles is defined as the point whose position vector is

$$\mathbf{R} = \frac{\sum m_i \mathbf{r}_i}{M}$$

9. Velocity of the centre of mass of a system of particles is given by $\mathbf{V} = \mathbf{P}/M$, where \mathbf{P} is the linear momentum of the system. The centre of mass moves as if all the mass of the system is concentrated at this point and all the external forces act at it. If the total external force on the system is zero, then the total linear momentum of the system is constant.
10. The angular momentum of a system of n particles about the origin is

$$\mathbf{L} = \sum_{i=1}^n \mathbf{r}_i \times \mathbf{p}_i$$

The torque or moment of force on a system of n particles about the origin is

$$\boldsymbol{\tau} = \sum_1 \mathbf{r}_i \times \mathbf{F}_i$$

The force \mathbf{F}_i acting on the i^{th} particle includes the external as well as internal forces. Assuming Newton's third law of motion and that forces between any two particles act along the line joining the particles, we can show $\boldsymbol{\tau}_{\text{int}} = \mathbf{0}$ and

$$\frac{d\mathbf{L}}{dt} = \boldsymbol{\tau}_{\text{ext}}$$

11. A rigid body is in mechanical equilibrium if

- (1) it is in translational equilibrium, i.e., the total external force on it is zero : $\sum \mathbf{F}_i = \mathbf{0}$,
and
(2) it is in rotational equilibrium, i.e. the total external torque on it is zero :
 $\sum \boldsymbol{\tau}_i = \sum \mathbf{r}_i \times \mathbf{F}_i = \mathbf{0}$.

12. The centre of gravity of an extended body is that point where the total gravitational torque on the body is zero.

13. The moment of inertia of a rigid body about an axis is defined by the formula $I = \sum m_i r_i^2$ where r_i is the perpendicular distance of the i th point of the body from the axis. The kinetic energy of rotation is $K = \frac{1}{2} I \omega^2$.

| Quantity | Symbols | Dimensions | Units | Remarks |
|-------------------|-----------------------|-------------------------------|---------------------|--|
| Angular velocity | $\boldsymbol{\omega}$ | $[\text{T}^{-1}]$ | rad s ⁻¹ | $\mathbf{v} = \boldsymbol{\omega} \times \mathbf{r}$ |
| Angular momentum | \mathbf{L} | $[\text{ML}^2 \text{T}^{-1}]$ | J s | $\mathbf{L} = \mathbf{r} \times \mathbf{p}$ |
| Torque | $\boldsymbol{\tau}$ | $[\text{ML}^2 \text{T}^{-2}]$ | N m | $\boldsymbol{\tau} = \mathbf{r} \times \mathbf{F}$ |
| Moment of inertia | I | $[\text{ML}^2]$ | kg m ² | $I = \sum m_i r_i^2$ |

POINTS TO PONDER

- To determine the motion of the centre of mass of a system no knowledge of internal forces of the system is required. For this purpose we need to know only the external forces on the body.
- Separating the motion of a system of particles as the motion of the centre of mass, (i.e., the translational motion of the system) and motion about (i.e. relative to) the centre of mass of the system is a useful technique in dynamics of a system of particles. One example of this technique is separating the kinetic energy of a system of particles K as the kinetic energy of the system about its centre of mass K' and the kinetic energy of the centre of mass $MV^2/2$,
$$K = K' + MV^2/2$$
- Newton's Second Law for finite sized bodies (or systems of particles) is based in Newton's Second Law and also Newton's Third Law for particles.
- To establish that the time rate of change of the total angular momentum of a system of particles is the total external torque in the system, we need not only Newton's second law for particles, but also Newton's third law with the provision that the forces between any two particles act along the line joining the particles.
- The vanishing of the total external force and the vanishing of the total external torque are independent conditions. We can have one without the other. In a couple, total external force is zero, but total torque is non-zero.
- The total torque on a system is independent of the origin if the total external force is zero.
- The centre of gravity of a body coincides with its centre of mass only if the gravitational field does not vary from one part of the body to the other.

8. The angular momentum \mathbf{L} and the angular velocity $\boldsymbol{\omega}$ are not necessarily parallel vectors. However, for the simpler situations discussed in this chapter when rotation is about a fixed axis which is an axis of symmetry of the rigid body, the relation $\mathbf{L} = I\boldsymbol{\omega}$ holds good, where I is the moment of the inertia of the body about the rotation axis.

EXERCISES

- 6.1 Give the location of the centre of mass of a (i) sphere, (ii) cylinder, (iii) ring, and (iv) cube, each of uniform mass density. Does the centre of mass of a body necessarily lie inside the body ?
- 6.2 In the HCl molecule, the separation between the nuclei of the two atoms is about 1.27 \AA ($1 \text{ \AA} = 10^{-10} \text{ m}$). Find the approximate location of the CM of the molecule, given that a chlorine atom is about 35.5 times as massive as a hydrogen atom and nearly all the mass of an atom is concentrated in its nucleus.
- 6.3 A child sits stationary at one end of a long trolley moving uniformly with a speed V on a smooth horizontal floor. If the child gets up and runs about on the trolley in any manner, what is the speed of the CM of the (trolley + child) system ?
- 6.4 Show that the area of the triangle contained between the vectors \mathbf{a} and \mathbf{b} is one half of the magnitude of $\mathbf{a} \times \mathbf{b}$.
- 6.5 Show that $\mathbf{a} \cdot (\mathbf{b} \times \mathbf{c})$ is equal in magnitude to the volume of the parallelepiped formed on the three vectors, \mathbf{a} , \mathbf{b} and \mathbf{c} .
- 6.6 Find the components along the x , y , z axes of the angular momentum \mathbf{l} of a particle, whose position vector is \mathbf{r} with components x , y , z and momentum is \mathbf{p} with components p_x , p_y and p_z . Show that if the particle moves only in the x - y plane the angular momentum has only a z -component.
- 6.7 Two particles, each of mass m and speed v , travel in opposite directions along parallel lines separated by a distance d . Show that the angular momentum vector of the two particle system is the same whatever be the point about which the angular momentum is taken.
- 6.8 A non-uniform bar of weight W is suspended at rest by two strings of negligible weight as shown in Fig.6.33. The angles made by the strings with the vertical are 36.9° and 53.1° respectively. The bar is 2 m long. Calculate the distance d of the centre of gravity of the bar from its left end.

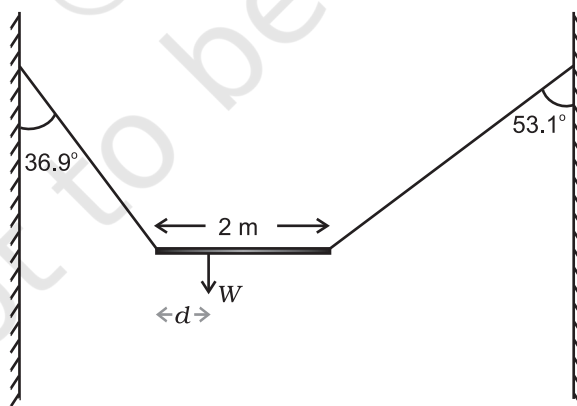

Fig. 6.33

- 6.9 A car weighs 1800 kg. The distance between its front and back axles is 1.8 m. Its centre of gravity is 1.05 m behind the front axle. Determine the force exerted by the level ground on each front wheel and each back wheel.

- 6.10** Torques of equal magnitude are applied to a hollow cylinder and a solid sphere, both having the same mass and radius. The cylinder is free to rotate about its standard axis of symmetry, and the sphere is free to rotate about an axis passing through its centre. Which of the two will acquire a greater angular speed after a given time.
- 6.11** A solid cylinder of mass 20 kg rotates about its axis with angular speed 100 rad s^{-1} . The radius of the cylinder is 0.25 m. What is the kinetic energy associated with the rotation of the cylinder? What is the magnitude of angular momentum of the cylinder about its axis?
- 6.12** (a) A child stands at the centre of a turntable with his two arms outstretched. The turntable is set rotating with an angular speed of 40 rev/min. How much is the angular speed of the child if he folds his hands back and thereby reduces his moment of inertia to $2/5$ times the initial value? Assume that the turntable rotates without friction.
- (b) Show that the child's new kinetic energy of rotation is more than the initial kinetic energy of rotation. How do you account for this increase in kinetic energy?
- 6.13** A rope of negligible mass is wound round a hollow cylinder of mass 3 kg and radius 40 cm. What is the angular acceleration of the cylinder if the rope is pulled with a force of 30 N? What is the linear acceleration of the rope? Assume that there is no slipping.
- 6.14** To maintain a rotor at a uniform angular speed of 200 rad s^{-1} , an engine needs to transmit a torque of 180 N m. What is the power required by the engine? (Note: uniform angular velocity in the absence of friction implies zero torque. In practice, applied torque is needed to counter frictional torque). Assume that the engine is 100% efficient.
- 6.15** From a uniform disk of radius R , a circular hole of radius $R/2$ is cut out. The centre of the hole is at $R/2$ from the centre of the original disc. Locate the centre of gravity of the resulting flat body.
- 6.16** A metre stick is balanced on a knife edge at its centre. When two coins, each of mass 5 g are put one on top of the other at the 12.0 cm mark, the stick is found to be balanced at 45.0 cm. What is the mass of the metre stick?
- 6.17** The oxygen molecule has a mass of $5.30 \times 10^{-26} \text{ kg}$ and a moment of inertia of $1.94 \times 10^{-46} \text{ kg m}^2$ about an axis through its centre perpendicular to the lines joining the two atoms. Suppose the mean speed of such a molecule in a gas is 500 m/s and that its kinetic energy of rotation is two thirds of its kinetic energy of translation. Find the average angular velocity of the molecule.



GRAVITATION

- 7.1 Introduction
- 7.2 Kepler's laws
- 7.3 Universal law of gravitation
- 7.4 The gravitational constant
- 7.5 Acceleration due to gravity of the earth
- 7.6 Acceleration due to gravity below and above the surface of earth
- 7.7 Gravitational potential energy
- 7.8 Escape speed
- 7.9 Earth satellites
- 7.10 Energy of an orbiting satellite
- Summary
- Points to ponder
- Exercises

7.1 INTRODUCTION

Early in our lives, we become aware of the tendency of all material objects to be attracted towards the earth. Anything thrown up falls down towards the earth, going uphill is lot more tiring than going downhill, raindrops from the clouds above fall towards the earth and there are many other such phenomena. Historically it was the Italian Physicist Galileo (1564-1642) who recognised the fact that all bodies, irrespective of their masses, are accelerated towards the earth with a constant acceleration. It is said that he made a public demonstration of this fact. To find the truth, he certainly did experiments with bodies rolling down inclined planes and arrived at a value of the acceleration due to gravity which is close to the more accurate value obtained later.

A seemingly unrelated phenomenon, observation of stars, planets and their motion has been the subject of attention in many countries since the earliest of times. Observations since early times recognised stars which appeared in the sky with positions unchanged year after year. The more interesting objects are the planets which seem to have regular motions against the background of stars. The earliest recorded model for planetary motions proposed by Ptolemy about 2000 years ago was a 'geocentric' model in which all celestial objects, stars, the sun and the planets, all revolved around the earth. The only motion that was thought to be possible for celestial objects was motion in a circle. Complicated schemes of motion were put forward by Ptolemy in order to describe the observed motion of the planets. The planets were described as moving in circles with the centre of the circles themselves moving in larger circles. Similar theories were also advanced by Indian astronomers some 400 years later. However a more elegant model in which the Sun was the centre around which the planets revolved – the 'heliocentric' model – was already mentioned by Aryabhata (5th century A.D.) in his treatise. A thousand years later, a Polish monk named Nicolas Copernicus (1473-1543)

proposed a definitive model in which the planets moved in circles around a fixed central sun. His theory was discredited by the church, but notable amongst its supporters was Galileo who had to face prosecution from the state for his beliefs.

It was around the same time as Galileo, a nobleman called Tycho Brahe (1546-1601) hailing from Denmark, spent his entire lifetime recording observations of the planets with the naked eye. His compiled data were analysed later by his assistant Johannes Kepler (1571-1640). He could extract from the data three elegant laws that now go by the name of Kepler's laws. These laws were known to Newton and enabled him to make a great scientific leap in proposing his universal law of gravitation.

7.2 KEPLER'S LAWS

The three laws of Kepler can be stated as follows:

1. Law of orbits : All planets move in elliptical orbits with the Sun situated at one of the foci

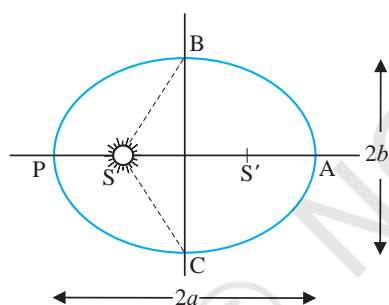

Fig. 7.1(a) An ellipse traced out by a planet around the sun. The closest point is P and the farthest point is A, P is called the perihelion and A the aphelion. The semimajor axis is half the distance AP.

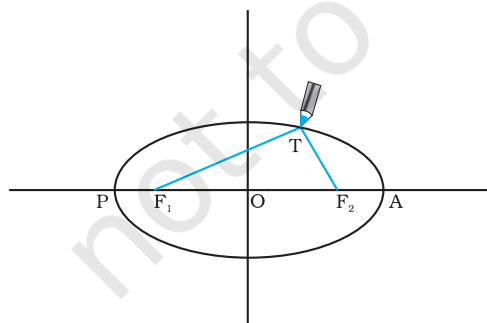

Fig. 7.1(b) Drawing an ellipse. A string has its ends fixed at F_1 and F_2 . The tip of a pencil holds the string taut and is moved around.

of the ellipse (Fig. 7.1a). This law was a deviation from the Copernican model which allowed only circular orbits. The ellipse, of which the circle is a special case, is a closed curve which can be drawn very simply as follows.

Select two points F_1 and F_2 . Take a length of a string and fix its ends at F_1 and F_2 by pins. With the tip of a pencil stretch the string taut and then draw a curve by moving the pencil keeping the string taut throughout. (Fig. 7.1(b)) The closed curve you get is called an ellipse. Clearly for any point T on the ellipse, the sum of the distances from F_1 and F_2 is a constant. F_1, F_2 are called the foci. Join the points F_1 and F_2 and extend the line to intersect the ellipse at points P and A as shown in Fig. 7.1(b). The midpoint of the line PA is the centre of the ellipse O and the length $PO = AO$ is called the semi-major axis of the ellipse. For a circle, the two foci merge into one and the semi-major axis becomes the radius of the circle.

2. Law of areas : The line that joins any planet to the sun sweeps equal areas in equal intervals of time (Fig. 7.2). This law comes from the observations that planets appear to move slower when they are farther from the sun than when they are nearer.

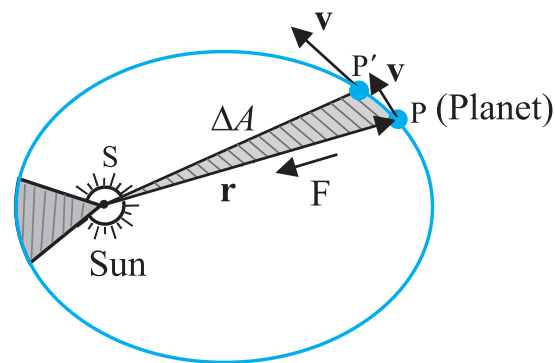

Fig. 7.2 The planet P moves around the sun in an elliptical orbit. The shaded area is the area ΔA swept out in a small interval of time Δt .

3. Law of periods : The square of the time period of revolution of a planet is proportional to the cube of the semi-major axis of the ellipse traced out by the planet.

Table 7.1 gives the approximate time periods of revolution of eight* planets around the sun along with values of their semi-major axes.

Table 7.1 Data from measurement of planetary motions given below confirm Kepler’s Law of Periods

- (a = Semi-major axis in units of 10^{10} m.
- T = Time period of revolution of the planet in years(y).
- Q = The quotient (T^2/a^3) in units of $10^{-34} \text{ y}^2 \text{ m}^{-3}$.)

| Planet | a | T | Q |
|---------|------|-------|------|
| Mercury | 5.79 | 0.24 | 2.95 |
| Venus | 10.8 | 0.615 | 3.00 |
| Earth | 15.0 | 1 | 2.96 |
| Mars | 22.8 | 1.88 | 2.98 |
| Jupiter | 77.8 | 11.9 | 3.01 |
| Saturn | 143 | 29.5 | 2.98 |
| Uranus | 287 | 84 | 2.98 |
| Neptune | 450 | 165 | 2.99 |

The law of areas can be understood as a consequence of conservation of angular momentum which is valid for any central force . A central force is such that the force on the planet is along the vector joining the Sun and the planet. Let the Sun be at the origin and let the position and momentum of the planet be denoted by \mathbf{r} and \mathbf{p} respectively. Then the area swept out by the planet of mass m in time interval Δt is (Fig. 7.2) ΔA given by

$$\Delta A = \frac{1}{2} (\mathbf{r} \times \mathbf{v} \Delta t) \tag{7.1}$$

Hence

$$\begin{aligned} \Delta A / \Delta t &= \frac{1}{2} (\mathbf{r} \times \mathbf{p}) / m, \text{ (since } \mathbf{v} = \mathbf{p} / m) \\ &= \mathbf{L} / (2 m) \end{aligned} \tag{7.2}$$

where \mathbf{v} is the velocity, \mathbf{L} is the angular momentum equal to $(\mathbf{r} \times \mathbf{p})$. For a central force, which is directed along \mathbf{r} , \mathbf{L} is a constant as the planet goes around. Hence, $\Delta A / \Delta t$ is a constant according to the last equation. This is

the law of areas. Gravitation is a central force and hence the law of areas follows.

► **Example 7.1** Let the speed of the planet at the perihelion P in Fig. 7.1(a) be v_p and the Sun-planet distance SP be r_p . Relate $\{r_p, v_p\}$ to the corresponding quantities at the aphelion $\{r_A, v_A\}$. Will the planet take equal times to traverse BAC and CPB ?

Answer The magnitude of the angular momentum at P is $L_p = m_p r_p v_p$, since inspection tells us that \mathbf{r}_p and \mathbf{v}_p are mutually perpendicular. Similarly, $L_A = m_p r_A v_A$. From angular momentum conservation

$$m_p r_p v_p = m_p r_A v_A$$

or
$$\frac{v_p}{v_A} = \frac{r_A}{r_p}$$

Since $r_A > r_p, v_p > v_A$.

The area $SBAC$ bounded by the ellipse and the radius vectors SB and SC is larger than $SBPC$ in Fig. 7.1. From Kepler’s second law, equal areas are swept in equal times. Hence the planet will take a longer time to traverse BAC than CPB .

7.3 UNIVERSAL LAW OF GRAVITATION

Legend has it that observing an apple falling from a tree, Newton was inspired to arrive at an universal law of gravitation that led to an explanation of terrestrial gravitation as well as of Kepler’s laws. Newton’s reasoning was that the moon revolving in an orbit of radius R_m was subject to a centripetal acceleration due to earth’s gravity of magnitude

$$a_m = \frac{V^2}{R_m} = \frac{4\pi^2 R_m}{T^2} \tag{7.3}$$

where V is the speed of the moon related to the time period T by the relation $V = 2\pi R_m / T$. The time period T is about 27.3 days and R_m was already known then to be about $3.84 \times 10^8 \text{ m}$. If we substitute these numbers in Eq. (7.3), we get a value of a_m much smaller than the value of acceleration due to gravity g on the surface of the earth, arising also due to earth’s gravitational attraction.

This clearly shows that the force due to earth's gravity decreases with distance. If one assumes that the gravitational force due to the earth decreases in proportion to the inverse square of the distance from the centre of the earth, we will have $a_m \propto R_m^{-2}$; $g \propto R_E^{-2}$ and we get

$$\frac{g}{a_m} = \frac{R_m^2}{R_E^2} \approx 3600 \quad (7.4)$$

in agreement with a value of $g \approx 9.8 \text{ m s}^{-2}$ and the value of a_m from Eq. (7.3). These observations led Newton to propose the following Universal Law of Gravitation :

Every body in the universe attracts every other body with a force which is directly proportional to the product of their masses and inversely proportional to the square of the distance between them.

The quotation is essentially from Newton's famous treatise called 'Mathematical Principles of Natural Philosophy' (Principia for short).

Stated Mathematically, Newton's gravitation law reads : The force \mathbf{F} on a point mass m_2 due to another point mass m_1 has the magnitude

$$|\mathbf{F}| = G \frac{m_1 m_2}{r^2} \quad (7.5)$$

Equation (7.5) can be expressed in vector form as

$$\begin{aligned} \mathbf{F} &= G \frac{m_1 m_2}{r^2} (-\hat{\mathbf{r}}) = -G \frac{m_1 m_2}{r^2} \hat{\mathbf{r}} \\ &= -G \frac{m_1 m_2}{|\mathbf{r}|^3} \mathbf{r} \end{aligned}$$

where G is the universal gravitational constant, $\hat{\mathbf{r}}$ is the unit vector from m_1 to m_2 and $\mathbf{r} = \mathbf{r}_2 - \mathbf{r}_1$ as shown in Fig. 7.3.

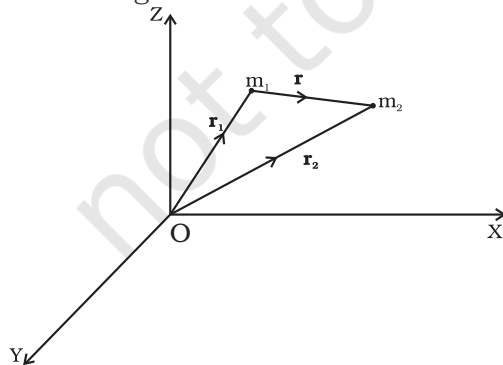

Fig. 7.3 Gravitational force on m_1 due to m_2 is along \mathbf{r} where the vector \mathbf{r} is $(\mathbf{r}_2 - \mathbf{r}_1)$.

The gravitational force is attractive, i.e., the force \mathbf{F} is along $-\mathbf{r}$. The force on point mass m_1 due to m_2 is of course $-\mathbf{F}$ by Newton's third law. Thus, the gravitational force \mathbf{F}_{12} on the body 1 due to 2 and \mathbf{F}_{21} on the body 2 due to 1 are related as $\mathbf{F}_{12} = -\mathbf{F}_{21}$.

Before we can apply Eq. (7.5) to objects under consideration, we have to be careful since the law refers to **point** masses whereas we deal with extended objects which have finite size. If we have a collection of point masses, the force on any one of them is the vector sum of the gravitational forces exerted by the other point masses as shown in Fig 7.4.

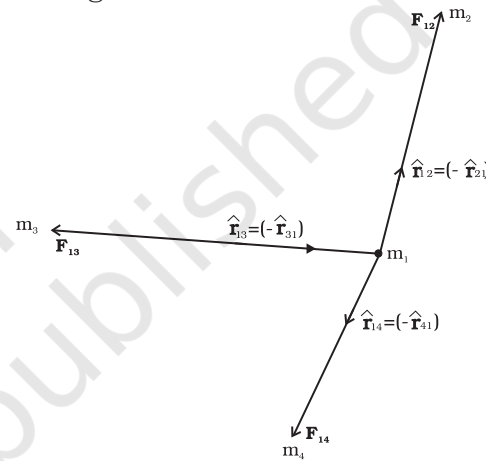

Fig. 7.4 Gravitational force on point mass m_1 is the vector sum of the gravitational forces exerted by m_2 , m_3 and m_4 .

The total force on m_1 is

$$\mathbf{F}_1 = \frac{Gm_2 m_1}{r_{21}^2} \hat{\mathbf{r}}_{21} + \frac{Gm_3 m_1}{r_{31}^2} \hat{\mathbf{r}}_{31} + \frac{Gm_4 m_1}{r_{41}^2} \hat{\mathbf{r}}_{41}$$

Example 7.2 Three equal masses of m kg each are fixed at the vertices of an equilateral triangle ABC.

(a) What is the force acting on a mass $2m$ placed at the centroid G of the triangle?

(b) What is the force if the mass at the vertex A is doubled?

Take $AG = BG = CG = 1 \text{ m}$ (see Fig. 7.5)

Answer (a) The angle between GC and the positive x -axis is 30° and so is the angle between GB and the negative x -axis. The individual forces in vector notation are

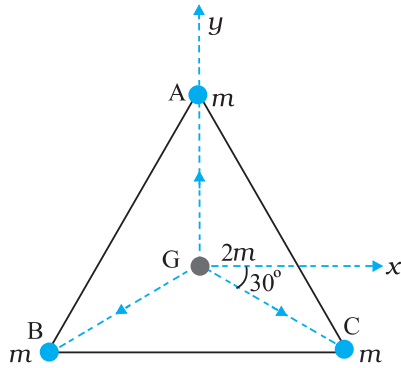

Fig. 7.5 Three equal masses are placed at the three vertices of the $\triangle ABC$. A mass $2m$ is placed at the centroid G .

$$\mathbf{F}_{GA} = \frac{Gm(2m)}{1} \hat{\mathbf{j}}$$

$$\mathbf{F}_{GB} = \frac{Gm(2m)}{1} (-\hat{\mathbf{i}} \cos 30^\circ - \hat{\mathbf{j}} \sin 30^\circ)$$

$$\mathbf{F}_{GC} = \frac{Gm(2m)}{1} (+\hat{\mathbf{i}} \cos 30^\circ - \hat{\mathbf{j}} \sin 30^\circ)$$

From the principle of superposition and the law of vector addition, the resultant gravitational force \mathbf{F}_R on $(2m)$ is

$$\mathbf{F}_R = \mathbf{F}_{GA} + \mathbf{F}_{GB} + \mathbf{F}_{GC}$$

$$\mathbf{F}_R = 2Gm^2 \hat{\mathbf{j}} + 2Gm^2 (-\hat{\mathbf{i}} \cos 30^\circ - \hat{\mathbf{j}} \sin 30^\circ) + 2Gm^2 (\hat{\mathbf{i}} \cos 30^\circ - \hat{\mathbf{j}} \sin 30^\circ) = 0$$

Alternatively, one expects on the basis of symmetry that the resultant force ought to be zero.

(b) Now if the mass at vertex A is doubled then

$$\mathbf{F}'_{GA} = \frac{G2m \cdot 2m}{1} \hat{\mathbf{j}} = 4Gm^2 \hat{\mathbf{j}}$$

$$\mathbf{F}'_{GB} = \mathbf{F}_{GB} \text{ and } \mathbf{F}'_{GC} = \mathbf{F}_{GC}$$

$$\mathbf{F}'_R = \mathbf{F}'_{GA} + \mathbf{F}'_{GB} + \mathbf{F}'_{GC}$$

$$\mathbf{F}'_R = 2Gm^2 \hat{\mathbf{j}} \quad \blacktriangleleft$$

For the gravitational force between an extended object (like the earth) and a point mass, Eq. (7.5) is not directly applicable. Each point mass in the extended object will exert a force on the given point mass and these force will not all be in the same direction. We have to add up these forces vectorially for all the point masses in the extended object to get the total force. This is easily done using calculus. For two special

cases, a simple law results when you do that :

- (1) **The force of attraction between a hollow spherical shell of uniform density and a point mass situated outside is just as if the entire mass of the shell is concentrated at the centre of the shell.**

Qualitatively this can be understood as follows: Gravitational forces caused by the various regions of the shell have components along the line joining the point mass to the centre as well as along a direction perpendicular to this line. The components perpendicular to this line cancel out when summing over all regions of the shell leaving only a resultant force along the line joining the point to the centre. The magnitude of this force works out to be as stated above.

- (2) **The force of attraction due to a hollow spherical shell of uniform density, on a point mass situated inside it is zero.**

Qualitatively, we can again understand this result. Various regions of the spherical shell attract the point mass inside it in various directions. These forces cancel each other completely.

7.4 THE GRAVITATIONAL CONSTANT

The value of the gravitational constant G entering the Universal law of gravitation can be determined experimentally and this was first done by English scientist Henry Cavendish in 1798. The apparatus used by him is schematically shown in Fig.7.6

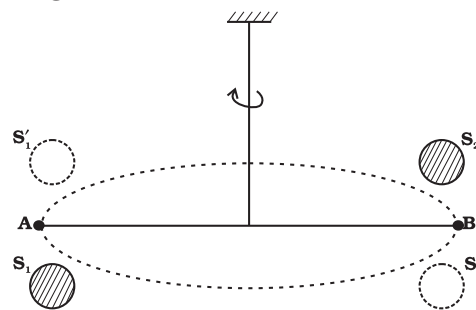

Fig. 7.6 Schematic drawing of Cavendish's experiment. S_1 and S_2 are large spheres which are kept on either side (shown shades) of the masses at A and B . When the big spheres are taken to the other side of the masses (shown by dotted circles), the bar AB rotates a little since the torque reverses direction. The angle of rotation can be measured experimentally.

hence

$$F = Gm \left(\frac{4\rho}{3} r \right) \frac{r^3}{r^2} = Gm \left(\frac{M_E}{R_E^3} \right) \frac{r^3}{r^2} = \frac{GmM_E}{R_E^3} r \quad (7.10)$$

If the mass m is situated on the surface of earth, then $r = R_E$ and the gravitational force on it is, from Eq. (7.10)

$$F = G \frac{M_E m}{R_E^2} \quad (7.11)$$

The acceleration experienced by the mass m , which is usually denoted by the symbol g is related to F by Newton's 2nd law by relation $F = mg$. Thus

$$g = \frac{F}{m} = \frac{GM_E}{R_E^2} \quad (7.12)$$

Acceleration g is readily measurable. R_E is a known quantity. The measurement of G by Cavendish's experiment (or otherwise), combined with knowledge of g and R_E enables one to estimate M_E from Eq. (7.12). This is the reason why there is a popular statement regarding Cavendish: "Cavendish weighed the earth".

7.6 ACCELERATION DUE TO GRAVITY BELOW AND ABOVE THE SURFACE OF EARTH

Consider a point mass m at a height h above the surface of the earth as shown in Fig. 7.8(a). The radius of the earth is denoted by R_E . Since this point is outside the earth,

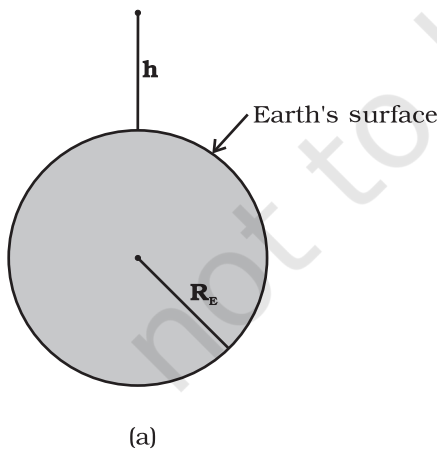

Fig. 7.8 (a) g at a height h above the surface of the earth.

its distance from the centre of the earth is $(R_E + h)$. If $F(h)$ denoted the magnitude of the force on the point mass m , we get from Eq. (7.5):

$$F(h) = \frac{GM_E m}{(R_E + h)^2} \quad (7.13)$$

The acceleration experienced by the point mass is $F(h)/m \equiv g(h)$ and we get

$$g(h) = \frac{F(h)}{m} = \frac{GM_E}{(R_E + h)^2} \quad (7.14)$$

This is clearly less than the value of g on the surface of earth: $g = \frac{GM_E}{R_E^2}$. For $h \ll R_E$, we can expand the RHS of Eq. (7.14):

$$g(h) = \frac{GM_E}{R_E^2(1 + h/R_E)^2} = g(1 + h/R_E)^{-2}$$

For $\frac{h}{R_E} \ll 1$, using binomial expression,

$$g(h) \cong g \left(1 - \frac{2h}{R_E} \right) \quad (7.15)$$

Equation (7.15) thus tells us that for small heights h above the value of g decreases by a factor $(1 - 2h/R_E)$.

Now, consider a point mass m at a depth d below the surface of the earth (Fig. 7.8(b)), so that its distance from the centre of the earth is $(R_E - d)$ as shown in the figure. The earth can be thought of as being composed of a smaller sphere of radius $(R_E - d)$ and a spherical shell of thickness d . The force on m due to the outer shell of thickness d is zero because the result quoted in the previous section. As far as the smaller sphere of radius $(R_E - d)$ is concerned, the point mass is outside it and hence according to the result quoted earlier, the force due to this smaller sphere is just as if the entire mass of the smaller sphere is concentrated at the centre. If M_s is the mass of the smaller sphere, then,

$$M_s/M_E = (R_E - d)^3 / R_E^3 \quad (7.16)$$

Since mass of a sphere is proportional to be cube of its radius.

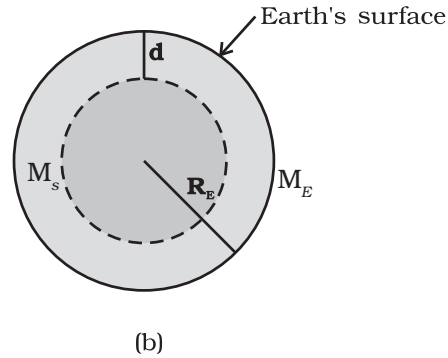

Fig. 7.8 (b) g at a depth d . In this case only the smaller sphere of radius $(R_E - d)$ contributes to g .

Thus the force on the point mass is

$$F(d) = G M_s m / (R_E - d)^2 \quad (7.17)$$

Substituting for M_s from above, we get

$$F(d) = G M_E m (R_E - d) / R_E^3 \quad (7.18)$$

and hence the acceleration due to gravity at a depth d ,

$$g(d) = \frac{F(d)}{m} \text{ is}$$

$$g(d) = \frac{F(d)}{m} = \frac{G M_E}{R_E^3} (R_E - d)$$

$$= g \frac{R_E - d}{R_E} = g(1 - d/R_E) \quad (7.19)$$

Thus, as we go down below earth's surface, the acceleration due gravity decreases by a factor $(1 - d/R_E)$. The remarkable thing about acceleration due to earth's gravity is that it is maximum on its surface decreasing whether you go up or down.

7.7 GRAVITATIONAL POTENTIAL ENERGY

We had discussed earlier the notion of potential energy as being the energy stored in the body at its given position. If the position of the particle changes on account of forces acting on it, then the change in its potential energy is just the amount of work done on the body by the force. As we had discussed earlier, forces for which the work done is independent of the path are the conservative forces.

The force of gravity is a conservative force and we can calculate the potential energy of a body arising out of this force, called the gravitational potential energy. Consider points

close to the surface of earth, at distances from the surface much smaller than the radius of the earth. In such cases, the force of gravity is practically a constant equal to mg , directed towards the centre of the earth. If we consider a point at a height h_1 from the surface of the earth and another point vertically above it at a height h_2 from the surface, the work done in lifting the particle of mass m from the first to the second position is denoted by W_{12}

$$\begin{aligned} W_{12} &= \text{Force} \times \text{displacement} \\ &= mg (h_2 - h_1) \end{aligned} \quad (7.20)$$

If we associate a potential energy $W(h)$ at a point at a height h above the surface such that

$$W(h) = mgh + W_0 \quad (7.21)$$

(where $W_0 = \text{constant}$);

then it is clear that

$$W_{12} = W(h_2) - W(h_1) \quad (7.22)$$

The work done in moving the particle is just the difference of potential energy between its final and initial positions. Observe that the constant W_0 cancels out in Eq. (7.22). Setting $h = 0$ in the last equation, we get $W(h = 0) = W_0$. $h = 0$ means points on the surface of the earth. Thus, W_0 is the potential energy on the surface of the earth.

If we consider points at arbitrary distance from the surface of the earth, the result just derived is not valid since the assumption that the gravitational force mg is a constant is no longer valid. However, from our discussion we know that a point outside the earth, the force of gravitation on a particle directed towards the centre of the earth is

$$F = \frac{G M_E m}{r^2} \quad (7.23)$$

where $M_E = \text{mass of earth}$, $m = \text{mass of the particle}$ and r its distance from the centre of the earth. If we now calculate the work done in lifting a particle from $r = r_1$ to $r = r_2$ ($r_2 > r_1$) along a vertical path, we get instead of Eq. (7.20)

$$\begin{aligned} W_{12} &= \int_{r_1}^{r_2} \frac{G M m}{r^2} dr \\ &= -G M_E m \left(\frac{1}{r_2} - \frac{1}{r_1} \right) \end{aligned} \quad (7.24)$$

In place of Eq. (7.21), we can thus associate a potential energy $W(r)$ at a distance r , such that

$$W(r) = -\frac{GM_E m}{r} + W_1, \quad (7.25)$$

valid for $r > R$,

so that once again $W_{12} = W(r_2) - W(r_1)$. Setting $r = \text{infinity}$ in the last equation, we get $W(r = \text{infinity}) = W_1$. Thus, W_1 is the potential energy at infinity. One should note that only the difference of potential energy between two points has a definite meaning from Eqs. (7.22) and (7.24). One conventionally sets W_1 equal to zero, so that the potential energy at a point is just the amount of work done in displacing the particle from infinity to that point.

We have calculated the potential energy at a point of a particle due to gravitational forces on it due to the earth and it is proportional to the mass of the particle. The gravitational potential due to the gravitational force of the earth is defined as the potential energy of a particle of unit mass at that point. From the earlier discussion, we learn that the gravitational potential energy associated with two particles of masses m_1 and m_2 separated by distance by a distance r is given by

$$V = -\frac{Gm_1 m_2}{r} \quad (\text{if we choose } V = 0 \text{ as } r \rightarrow \infty)$$

It should be noted that an isolated system of particles will have the total potential energy that equals the sum of energies (given by the above equation) for all possible pairs of its constituent particles. This is an example of the application of the superposition principle.

Example 7.3 Find the potential energy of a system of four particles placed at the vertices of a square of side l . Also obtain the potential at the centre of the square.

Answer Consider four masses each of mass m at the corners of a square of side l ; See Fig. 7.9. We have four mass pairs at distance l and two diagonal pairs at distance $\sqrt{2}l$

Hence,

$$\begin{aligned} W(r) &= -4 \frac{Gm^2}{l} - 2 \frac{Gm^2}{\sqrt{2}l} \\ &= -\frac{2Gm^2}{l} \left(2 + \frac{1}{\sqrt{2}} \right) = -5.41 \frac{Gm^2}{l} \end{aligned}$$

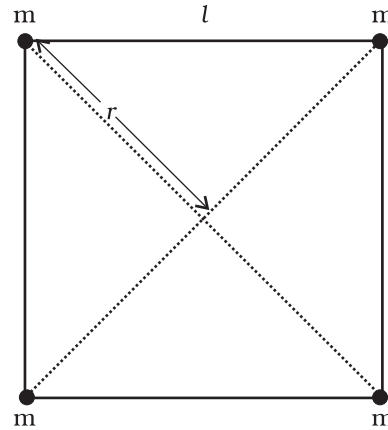

Fig. 7.9

The gravitational potential at the centre of the square ($r = \sqrt{2}l/2$) is

$$U(r) = -4\sqrt{2} \frac{Gm}{l}$$

7.8 ESCAPE SPEED

If a stone is thrown by hand, we see it falls back to the earth. Of course using machines we can shoot an object with much greater speeds and with greater and greater initial speed, the object scales higher and higher heights. A natural query that arises in our mind is the following: 'can we throw an object with such high initial speeds that it does not fall back to the earth?'

The principle of conservation of energy helps us to answer this question. Suppose the object did reach infinity and that its speed there was V_f . The energy of an object is the sum of potential and kinetic energy. As before W_1 denotes that gravitational potential energy of the object at infinity. The total energy of the projectile at infinity then is

$$E(\infty) = W_1 + \frac{mV_f^2}{2} \quad (7.26)$$

If the object was thrown initially with a speed V_i from a point at a distance $(h+R_E)$ from the centre of the earth ($R_E = \text{radius of the earth}$), its energy initially was

$$E(h+R_E) = \frac{1}{2}mV_i^2 - \frac{GmM_E}{(h+R_E)} + W_1 \quad (7.27)$$

By the principle of energy conservation Eqs. (7.26) and (7.27) must be equal. Hence

$$\frac{mV_i^2}{2} - \frac{GmM_E}{(h + R_E)} = \frac{mV_f^2}{2} \quad (7.28)$$

The R.H.S. is a positive quantity with a minimum value zero hence so must be the L.H.S. Thus, an object can reach infinity as long as V_i is such that

$$\frac{mV_i^2}{2} - \frac{GmM_E}{(h + R_E)} \geq 0 \quad (7.29)$$

The minimum value of V_i corresponds to the case when the L.H.S. of Eq. (7.29) equals zero. Thus, the minimum speed required for an object to reach infinity (i.e. escape from the earth) corresponds to

$$\frac{1}{2}m(V_i)_{\min}^2 = \frac{GmM_E}{h + R_E} \quad (7.30)$$

If the object is thrown from the surface of the earth, $h = 0$, and we get

$$(V_i)_{\min} = \sqrt{\frac{2GM_E}{R_E}} \quad (7.31)$$

Using the relation $g = GM_E / R_E^2$, we get

$$(V_i)_{\min} = \sqrt{2gR_E} \quad (7.32)$$

Using the value of g and R_E , numerically $(V_i)_{\min} \approx 11.2$ km/s. This is called the escape speed, sometimes loosely called the escape velocity.

Equation (7.32) applies equally well to an object thrown from the surface of the moon with g replaced by the acceleration due to Moon's gravity on its surface and r_E replaced by the radius of the moon. Both are smaller than their values on earth and the escape speed for the moon turns out to be 2.3 km/s, about five times smaller. This is the reason that moon has no atmosphere. Gas molecules if formed on the surface of the moon having velocities larger than this will escape the gravitational pull of the moon.

Example 7.4 Two uniform solid spheres of equal radii R , but mass M and $4M$ have a centre to centre separation $6R$, as shown in Fig. 7.10. The two spheres are held fixed. A projectile of mass m is projected from the surface of the sphere of mass M directly towards the centre of the second sphere. Obtain an expression for the minimum speed v of the projectile so that it reaches the surface of the second sphere.

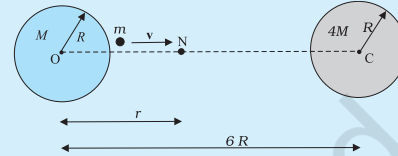

Fig. 7.10

Answer The projectile is acted upon by two mutually opposing gravitational forces of the two spheres. The neutral point N (see Fig. 7.10) is defined as the position where the two forces cancel each other exactly. If $ON = r$, we have

$$\begin{aligned} \frac{GMm}{r^2} &= \frac{4GMm}{(6R-r)^2} \\ (6R-r)^2 &= 4r^2 \\ 6R-r &= \pm 2r \\ r &= 2R \quad \text{or} \quad -6R. \end{aligned}$$

The neutral point $r = -6R$ does not concern us in this example. Thus $ON = r = 2R$. It is sufficient to project the particle with a speed which would enable it to reach N. Thereafter, the greater gravitational pull of $4M$ would suffice. The mechanical energy at the surface of M is

$$E_i = \frac{1}{2}mv^2 - \frac{GMm}{R} - \frac{4GMm}{5R}.$$

At the neutral point N, the speed approaches zero. The mechanical energy at N is purely potential.

$$E_N = -\frac{GMm}{2R} - \frac{4GMm}{4R}.$$

From the principle of conservation of mechanical energy

$$\frac{1}{2}mv^2 - \frac{GMm}{R} - \frac{4GMm}{5R} = -\frac{GMm}{2R} - \frac{4GMm}{4R}$$

or

$$v^2 = \frac{2GM}{R} \left(\frac{4}{5} - \frac{1}{2} \right)$$

$$v = \left(\frac{3GM}{5R} \right)^{1/2}$$

A point to note is that the speed of the projectile is zero at N, but is nonzero when it strikes the heavier sphere $4M$. The calculation of this speed is left as an exercise to the students.

7.9 EARTH SATELLITES

Earth satellites are objects which revolve around the earth. Their motion is very similar to the motion of planets around the Sun and hence Kepler's laws of planetary motion are equally applicable to them. In particular, their orbits around the earth are circular or elliptic. Moon is the only natural satellite of the earth with a near circular orbit with a time period of approximately 27.3 days which is also roughly equal to the rotational period of the moon about its own axis. Since, 1957, advances in technology have enabled many countries including India to launch artificial earth satellites for practical use in fields like telecommunication, geophysics and meteorology.

We will consider a satellite in a circular orbit of a distance $(R_E + h)$ from the centre of the earth, where R_E = radius of the earth. If m is the mass of the satellite and V its speed, the centripetal force required for this orbit is

$$F(\text{centripetal}) = \frac{mV^2}{(R_E + h)} \quad (7.33)$$

directed towards the centre. This centripetal force is provided by the gravitational force, which is

$$F(\text{gravitation}) = \frac{GmM_E}{(R_E + h)^2} \quad (7.34)$$

where M_E is the mass of the earth.

Equating R.H.S of Eqs. (7.33) and (7.34) and cancelling out m , we get

$$V^2 = \frac{GM_E}{(R_E + h)} \quad (7.35)$$

Thus V decreases as h increases. From equation (7.35), the speed V for $h = 0$ is

$$V^2 (h = 0) = GM / R_E = gR_E \quad (7.36)$$

where we have used the relation $g = GM / R_E^2$. In every orbit, the satellite

traverses a distance $2\pi(R_E + h)$ with speed V . Its time period T therefore is

$$T = \frac{2\pi(R_E + h)}{V} = \frac{2\pi(R_E + h)^{3/2}}{\sqrt{GM_E}} \quad (7.37)$$

on substitution of value of V from Eq. (7.35). Squaring both sides of Eq. (7.37), we get

$$T^2 = k (R_E + h)^3 \quad (\text{where } k = 4\pi^2 / GM_E) \quad (7.38)$$

which is Kepler's law of periods, as applied to motion of satellites around the earth. For a satellite very close to the surface of earth h can be neglected in comparison to R_E in Eq. (7.38). Hence, for such satellites, T is T_0 , where

$$T_0 = 2\pi\sqrt{R_E / g} \quad (7.39)$$

If we substitute the numerical values $g \approx 9.8 \text{ m s}^{-2}$ and $R_E = 6400 \text{ km}$., we get

$$T_0 = 2\pi\sqrt{\frac{6.4 \times 10^6}{9.8}} \text{ s}$$

Which is approximately 85 minutes.

Example 7.5 The planet Mars has two moons, phobos and delmos. (i) phobos has a period 7 hours, 39 minutes and an orbital radius of $9.4 \times 10^3 \text{ km}$. Calculate the mass of mars. (ii) Assume that earth and mars move in circular orbits around the sun, with the martian orbit being 1.52 times the orbital radius of the earth. What is the length of the martian year in days ?

Answer (i) We employ Eq. (7.38) with the sun's mass replaced by the martian mass M_m

$$T^2 = \frac{4\pi^2}{GM_m} R^3$$

$$M_m = \frac{4\pi^2 R^3}{G T^2}$$

$$= \frac{4 \times (3.14)^2 \times (9.4)^3 \times 10^{18}}{6.67 \times 10^{-11} \times (459 \times 60)^2}$$

$$M_m = \frac{4 \times (3.14)^2 \times (9.4)^3 \times 10^{18}}{6.67 \times (4.59 \times 6)^2 \times 10^{-5}}$$

$$= 6.48 \times 10^{23} \text{ kg.}$$

(ii) Once again Kepler's third law comes to our aid,

$$\frac{T_M^2}{T_E^2} = \frac{R_{MS}^3}{R_{ES}^3}$$

where R_{MS} is the mars -sun distance and R_{ES} is the earth-sun distance.

$$\begin{aligned}\therefore T_M &= (1.52)^{3/2} \times 365 \\ &= 684 \text{ days}\end{aligned}$$

We note that the orbits of all planets except Mercury and Mars are very close to being circular. For example, the ratio of the semi-minor to semi-major axis for our Earth is, $b/a = 0.99986$.

Example 7.6 Weighing the Earth : You are given the following data: $g = 9.81 \text{ ms}^{-2}$, $R_E = 6.37 \times 10^6 \text{ m}$, the distance to the moon $R = 3.84 \times 10^8 \text{ m}$ and the time period of the moon's revolution is 27.3 days. Obtain the mass of the Earth M_E in two different ways.

Answer From Eq. (7.12) we have

$$\begin{aligned}M_E &= \frac{g R_E^2}{G} \\ &= \frac{9.81 \times (6.37 \times 10^6)^2}{6.67 \times 10^{-11}} \\ &= 5.97 \times 10^{24} \text{ kg}.\end{aligned}$$

The moon is a satellite of the Earth. From the derivation of Kepler's third law [see Eq. (7.38)]

$$\begin{aligned}T^2 &= \frac{4\pi^2 R^3}{G M_E} \\ M_E &= \frac{4\pi^2 R^3}{G T^2} \\ &= \frac{4 \times 3.14 \times 3.14 \times (3.84)^3 \times 10^{24}}{6.67 \times 10^{-11} \times (27.3 \times 24 \times 60)^2} \\ &= 6.02 \times 10^{24} \text{ kg}\end{aligned}$$

Both methods yield almost the same answer, the difference between them being less than 1%.

Example 7.7 Express the constant k of Eq. (7.38) in days and kilometres. Given $k = 10^{-13} \text{ s}^2 \text{ m}^{-3}$. The moon is at a distance of $3.84 \times 10^5 \text{ km}$ from the earth. Obtain its time-period of revolution in days.

Answer Given

$$k = 10^{-13} \text{ s}^2 \text{ m}^{-3}$$

$$\begin{aligned}&= 10^{-13} \left[\frac{1}{(24 \times 60 \times 60)^2} \text{ d}^2 \right] \left[\frac{1}{(1/1000)^3 \text{ km}^3} \right] \\ &= 1.33 \times 10^{-14} \text{ d}^2 \text{ km}^{-3}\end{aligned}$$

Using Eq. (7.38) and the given value of k , the time period of the moon is

$$\begin{aligned}T^2 &= (1.33 \times 10^{-14})(3.84 \times 10^5)^3 \\ T &= 27.3 \text{ d}\end{aligned}$$

Note that Eq. (7.38) also holds for elliptical orbits if we replace $(R_E + h)$ by the semi-major axis of the ellipse. The earth will then be at one of the foci of this ellipse.

7.10 ENERGY OF AN ORBITING SATELLITE

Using Eq. (7.35), the kinetic energy of the satellite in a circular orbit with speed v is

$$\begin{aligned}K \cdot E &= \frac{1}{2} m v^2 \\ &= \frac{G m M_E}{2(R_E + h)}.\end{aligned}\tag{7.40}$$

Considering gravitational potential energy at infinity to be zero, the potential energy at distance $(R_E + h)$ from the centre of the earth is

$$P.E = -\frac{G m M_E}{(R_E + h)}\tag{7.41}$$

The K.E is positive whereas the P.E is negative. However, in magnitude the K.E. is half the P.E, so that the total E is

$$E = K.E + P.E = -\frac{G m M_E}{2(R_E + h)}\tag{7.42}$$

The total energy of an circularly orbiting satellite is thus negative, with the potential energy being negative but twice is magnitude of the positive kinetic energy.

When the orbit of a satellite becomes elliptic, both the $K.E.$ and $P.E.$ vary from point to point. The total energy which remains constant is negative as in the circular orbit case. This is what we expect, since as we have discussed before if the total energy is positive or zero, the object escapes to infinity. Satellites are always at finite distance from the earth and hence their energies cannot be positive or zero.

Example 7.8 A 400 kg satellite is in a circular orbit of radius $2R_E$ about the Earth. How much energy is required to transfer it to a circular orbit of radius $4R_E$? What are the changes in the kinetic and potential energies?

Answer Initially,

$$E_i = -\frac{G M_E m}{4 R_E}$$

While finally

$$E_f = -\frac{G M_E m}{8 R_E}$$

The change in the total energy is

$$\Delta E = E_f - E_i$$

$$= \frac{G M_E m}{8 R_E} = \left(\frac{G M_E}{R_E^2} \right) \frac{m R_E}{8}$$

$$\Delta E = \frac{g m R_E}{8} = \frac{9.81 \times 400 \times 6.37 \times 10^6}{8} = 3.13 \times 10^9 \text{ J}$$

The kinetic energy is reduced and it mimics ΔE , namely, $\Delta K = K_f - K_i = -3.13 \times 10^9 \text{ J}$.

The change in potential energy is twice the change in the total energy, namely $\Delta V = V_f - V_i = -6.25 \times 10^9 \text{ J}$

SUMMARY

- Newton's law of universal gravitation states that the gravitational force of attraction between any two particles of masses m_1 and m_2 separated by a distance r has the magnitude

$$F = G \frac{m_1 m_2}{r^2}$$

where G is the universal gravitational constant, which has the value $6.672 \times 10^{-11} \text{ N m}^2 \text{ kg}^{-2}$.

- If we have to find the resultant gravitational force acting on the particle m due to a number of masses M_1, M_2, \dots, M_n etc. we use the principle of superposition. Let F_1, F_2, \dots, F_n be the individual forces due to M_1, M_2, \dots, M_n , each given by the law of gravitation. From the principle of superposition each force acts independently and uninfluenced by the other bodies. The resultant force F_R is then found by vector addition

$$F_R = F_1 + F_2 + \dots + F_n = \sum_{i=1}^n F_i$$

where the symbol ' Σ ' stands for summation.

- Kepler's laws of planetary motion state that
 - All planets move in elliptical orbits with the Sun at one of the focal points
 - The radius vector drawn from the Sun to a planet sweeps out equal areas in equal time intervals. This follows from the fact that the force of gravitation on the planet is central and hence angular momentum is conserved.
 - The square of the orbital period of a planet is proportional to the cube of the semi-major axis of the elliptical orbit of the planet

The period T and radius R of the circular orbit of a planet about the Sun are related by

$$T^2 = \left(\frac{4\pi^2}{G M_s} \right) R^3$$

where M_s is the mass of the Sun. Most planets have nearly circular orbits about the Sun. For elliptical orbits, the above equation is valid if R is replaced by the semi-major axis, a .

- The acceleration due to gravity.
 - at a height h above the earth's surface

$$g(h) = \frac{G M_E}{(R_E + h)^2}$$

$$\approx \frac{G M_E}{R_E^2} \left(1 - \frac{2h}{R_E} \right) \text{ for } h \ll R_E$$

$$g(h) = g(0) \left(1 - \frac{2h}{R_E} \right) \quad \text{where } g(0) = \frac{G M_E}{R_E^2}$$

(b) at depth d below the earth's surface is

$$g(d) = \frac{G M_E}{R_E^2} \left(1 - \frac{d}{R_E} \right) = g(0) \left(1 - \frac{d}{R_E} \right)$$

5. The gravitational force is a conservative force, and therefore a potential energy function can be defined. The *gravitational potential energy* associated with two particles separated by a distance r is given by

$$V = - \frac{G m_1 m_2}{r}$$

where V is taken to be zero at $r \rightarrow \infty$. The total potential energy for a system of particles is the sum of energies for all pairs of particles, with each pair represented by a term of the form given by above equation. This prescription follows from the principle of superposition.

6. If an isolated system consists of a particle of mass m moving with a speed v in the vicinity of a massive body of mass M , the total mechanical energy of the particle is given by

$$E = \frac{1}{2} m v^2 - \frac{G M m}{r}$$

That is, the total mechanical energy is the sum of the kinetic and potential energies. The total energy is a constant of motion.

7. If m moves in a circular orbit of radius a about M , where $M \gg m$, the total energy of the system is

$$E = - \frac{G M m}{2a}$$

with the choice of the arbitrary constant in the potential energy given in the point 5., above. The total energy is negative for any bound system, that is, one in which the orbit is closed, such as an elliptical orbit. The kinetic and potential energies are

$$K = \frac{G M m}{2a}$$

$$V = - \frac{G M m}{a}$$

8. The escape speed from the surface of the earth is

$$v_e = \sqrt{\frac{2 G M_E}{R_E}} = \sqrt{2 g R_E}$$

and has a value of 11.2 km s^{-1} .

9. If a particle is outside a uniform spherical shell or solid sphere with a spherically symmetric internal mass distribution, the sphere attracts the particle as though the mass of the sphere or shell were concentrated at the centre of the sphere.
10. If a particle is inside a uniform spherical shell, the gravitational force on the particle is zero. If a particle is inside a homogeneous solid sphere, the force on the particle acts toward the centre of the sphere. This force is exerted by the spherical mass interior to the particle.

| Physical Quantity | Symbol | Dimensions | Unit | Remarks |
|--------------------------------|---------------------------------|-----------------------|--------------------------------|---|
| Gravitational Constant | G | $[M^{-1} L^3 T^{-2}]$ | $\text{N m}^2 \text{ kg}^{-2}$ | 6.67×10^{-11} |
| Gravitational Potential Energy | $V(r)$ | $[M L^2 T^{-2}]$ | J | $-\frac{GMm}{r}$ (scalar) |
| Gravitational Potential | $U(r)$ | $[L^2 T^{-2}]$ | J kg^{-1} | $-\frac{GM}{r}$ (scalar) |
| Gravitational Intensity | \mathbf{E} or \mathbf{g} | $[L T^{-2}]$ | m s^{-2} | $\frac{GM}{r^2} \hat{\mathbf{r}}$ (vector) |

POINTS TO PONDER

- In considering motion of an object under the gravitational influence of another object the following quantities are conserved:
 - Angular momentum
 - Total mechanical energy
 Linear momentum is **not** conserved
- Angular momentum conservation leads to Kepler's second law. However, it is not special to the inverse square law of gravitation. It holds for any central force.
- In Kepler's third law (see Eq. (7.1) and $T^2 = K_s R^3$). The constant K_s is the same for all planets in circular orbits. This applies to satellites orbiting the Earth [(Eq. (7.38))].
- An astronaut experiences weightlessness in a space satellite. This is not because the gravitational force is small at that location in space. It is because both the astronaut and the satellite are in "free fall" towards the Earth.
- The *gravitational potential energy* associated with two particles separated by a distance r is given by

$$V = -\frac{G m_1 m_2}{r} + \text{constant}$$

The constant can be given any value. The simplest choice is to take it to be zero. With this choice

$$V = -\frac{G m_1 m_2}{r}$$

This choice implies that $V \rightarrow 0$ as $r \rightarrow \infty$. Choosing location of zero of the gravitational energy is the same as choosing the arbitrary constant in the potential energy. Note that the gravitational force is not altered by the choice of this constant.

- The total mechanical energy of an object is the sum of its kinetic energy (which is always positive) and the potential energy. Relative to infinity (i.e. if we presume that the potential energy of the object at infinity is zero), the gravitational potential energy of an object is negative. The total energy of a satellite is negative.
- The commonly encountered expression mgh for the potential energy is actually an approximation to the difference in the gravitational potential energy discussed in the point 6, above.
- Although the gravitational force between two particles is central, the force between two finite rigid bodies is not necessarily along the line joining their centre of mass. For a spherically symmetric body however the force on a particle external to the body is as if the mass is concentrated at the centre and this force is therefore central.
- The gravitational force on a particle inside a spherical shell is zero. However, (unlike a metallic shell which shields electrical forces) the shell does not shield other bodies outside it from exerting gravitational forces on a particle inside. *Gravitational shielding is not possible.*

EXERCISES

7.1 Answer the following :

- You can shield a charge from electrical forces by putting it inside a hollow conductor. Can you shield a body from the gravitational influence of nearby matter by putting it inside a hollow sphere or by some other means ?
- An astronaut inside a small space ship orbiting around the earth cannot detect gravity. If the space station orbiting around the earth has a large size, can he hope to detect gravity ?
- If you compare the gravitational force on the earth due to the sun to that due to the moon, you would find that the Sun's pull is greater than the moon's pull. (you can check this yourself using the data available in the succeeding exercises). However, the tidal effect of the moon's pull is greater than the tidal effect of sun. Why ?

- 7.2** Choose the correct alternative :
- Acceleration due to gravity increases/decreases with increasing altitude.
 - Acceleration due to gravity increases/decreases with increasing depth (assume the earth to be a sphere of uniform density).
 - Acceleration due to gravity is independent of mass of the earth/mass of the body.
 - The formula $-GMm(1/r_2 - 1/r_1)$ is more/less accurate than the formula $mg(r_2 - r_1)$ for the difference of potential energy between two points r_2 and r_1 distance away from the centre of the earth.
- 7.3** Suppose there existed a planet that went around the Sun twice as fast as the earth. What would be its orbital size as compared to that of the earth ?
- 7.4** Io, one of the satellites of Jupiter, has an orbital period of 1.769 days and the radius of the orbit is 4.22×10^8 m. Show that the mass of Jupiter is about one-thousandth that of the sun.
- 7.5** Let us assume that our galaxy consists of 2.5×10^{11} stars each of one solar mass. How long will a star at a distance of 50,000 ly from the galactic centre take to complete one revolution ? Take the diameter of the Milky Way to be 10^5 ly.
- 7.6** Choose the correct alternative:
- If the zero of potential energy is at infinity, the total energy of an orbiting satellite is negative of its kinetic/potential energy.
 - The energy required to launch an orbiting satellite out of earth's gravitational influence is more/less than the energy required to project a stationary object at the same height (as the satellite) out of earth's influence.
- 7.7** Does the escape speed of a body from the earth depend on (a) the mass of the body, (b) the location from where it is projected, (c) the direction of projection, (d) the height of the location from where the body is launched?
- 7.8** A comet orbits the sun in a highly elliptical orbit. Does the comet have a constant (a) linear speed, (b) angular speed, (c) angular momentum, (d) kinetic energy, (e) potential energy, (f) total energy throughout its orbit? Neglect any mass loss of the comet when it comes very close to the Sun.
- 7.9** Which of the following symptoms is likely to afflict an astronaut in space (a) swollen feet, (b) swollen face, (c) headache, (d) orientational problem.
- 7.10** In the following two exercises, choose the correct answer from among the given ones: The gravitational intensity at the centre of a hemispherical shell of uniform mass density has the direction indicated by the arrow (see Fig 7.11) (i) a, (ii) b, (iii) c, (iv) 0.

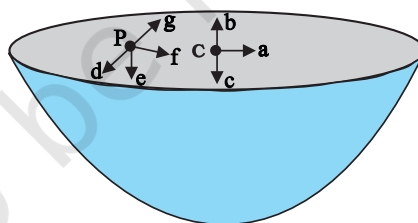

Fig. 7.11

- 7.11** For the above problem, the direction of the gravitational intensity at an arbitrary point P is indicated by the arrow (i) d, (ii) e, (iii) f, (iv) g.
- 7.12** A rocket is fired from the earth towards the sun. At what distance from the earth's centre is the gravitational force on the rocket zero ? Mass of the sun = 2×10^{30} kg, mass of the earth = 6×10^{24} kg. Neglect the effect of other planets etc. (orbital radius = 1.5×10^{11} m).
- 7.13** How will you 'weigh the sun', that is estimate its mass? The mean orbital radius of the earth around the sun is 1.5×10^8 km.
- 7.14** A saturn year is 29.5 times the earth year. How far is the saturn from the sun if the earth is 1.50×10^8 km away from the sun ?
- 7.15** A body weighs 63 N on the surface of the earth. What is the gravitational force on it due to the earth at a height equal to half the radius of the earth ?

- 7.16** Assuming the earth to be a sphere of uniform mass density, how much would a body weigh half way down to the centre of the earth if it weighed 250 N on the surface ?
- 7.17** A rocket is fired vertically with a speed of 5 km s^{-1} from the earth's surface. How far from the earth does the rocket go before returning to the earth ? Mass of the earth = $6.0 \times 10^{24} \text{ kg}$; mean radius of the earth = $6.4 \times 10^6 \text{ m}$; $G = 6.67 \times 10^{-11} \text{ N m}^2 \text{ kg}^{-2}$.
- 7.18** The escape speed of a projectile on the earth's surface is 11.2 km s^{-1} . A body is projected out with thrice this speed. What is the speed of the body far away from the earth? Ignore the presence of the sun and other planets.
- 7.19** A satellite orbits the earth at a height of 400 km above the surface. How much energy must be expended to rocket the satellite out of the earth's gravitational influence? Mass of the satellite = 200 kg; mass of the earth = $6.0 \times 10^{24} \text{ kg}$; radius of the earth = $6.4 \times 10^6 \text{ m}$; $G = 6.67 \times 10^{-11} \text{ N m}^2 \text{ kg}^{-2}$.
- 7.20** Two stars each of one solar mass ($= 2 \times 10^{30} \text{ kg}$) are approaching each other for a head on collision. When they are a distance 10^9 km , their speeds are negligible. What is the speed with which they collide ? The radius of each star is 10^4 km . Assume the stars to remain undistorted until they collide. (Use the known value of G).
- 7.21** Two heavy spheres each of mass 100 kg and radius 0.10 m are placed 1.0 m apart on a horizontal table. What is the gravitational force and potential at the mid point of the line joining the centres of the spheres ? Is an object placed at that point in equilibrium? If so, is the equilibrium stable or unstable ?

APPENDICES

APPENDIX A 1 THE GREEK ALPHABET

| | | | | | | | | |
|---------|---|---|---------|---|---|---------|---|------|
| Alpha | A | α | Iota | I | ι | Rho | P | ρ |
| Beta | B | β | Kappa | K | κ | Sigma | Σ | σ |
| Gamma | Γ | γ | Lambda | Λ | λ | Tau | T | τ |
| Delta | Δ | δ | Mu | M | μ | Upsilon | Υ | υ |
| Epsilon | E | ε | Nu | N | ν | Phi | Φ | φ, ϕ |
| Zeta | Z | ζ | Xi | Ξ | ξ | Chi | Χ | χ |
| Eta | H | η | Omicron | O | ο | Psi | Ψ | ψ |
| Theta | Θ | θ | Pi | Π | π | Omega | Ω | ω |

APPENDIX A 2 COMMON SI PREFIXES AND SYMBOLS FOR MULTIPLES AND SUB-MULTIPLES

| Multiple | | | Sub-Multiple | | |
|-----------|--------|--------|--------------|--------|--------|
| Factor | Prefix | Symbol | Factor | Prefix | symbol |
| 10^{18} | Exa | E | 10^{-18} | atto | a |
| 10^{15} | Peta | P | 10^{-15} | femto | f |
| 10^{12} | Tera | T | 10^{-12} | pico | p |
| 10^9 | Giga | G | 10^{-9} | nano | n |
| 10^6 | Mega | M | 10^{-6} | micro | μ |
| 10^3 | kilo | k | 10^{-3} | milli | m |
| 10^2 | Hecto | h | 10^{-2} | centi | c |
| 10^1 | Deca | da | 10^{-1} | deci | d |

APPENDIX A 3
SOME IMPORTANT CONSTANTS

| Name | Symbol | Value |
|-------------------------------|--------------------|---|
| Speed of light in vacuum | c | $2.9979 \times 10^8 \text{ m s}^{-1}$ |
| Charge of electron | e | $1.602 \times 10^{-19} \text{ C}$ |
| Gravitational constant | G | $6.673 \times 10^{-11} \text{ N m}^2 \text{ kg}^{-2}$ |
| Planck constant | h | $6.626 \times 10^{-34} \text{ J s}$ |
| Boltzmann constant | k | $1.381 \times 10^{-23} \text{ J K}^{-1}$ |
| Avogadro number | N_A | $6.022 \times 10^{23} \text{ mol}^{-1}$ |
| Universal gas constant | R | $8.314 \text{ J mol}^{-1} \text{ K}^{-1}$ |
| Mass of electron | m_e | $9.110 \times 10^{-31} \text{ kg}$ |
| Mass of neutron | m_n | $1.675 \times 10^{-27} \text{ kg}$ |
| Mass of proton | m_p | $1.673 \times 10^{-27} \text{ kg}$ |
| Electron-charge to mass ratio | e/m_e | $1.759 \times 10^{11} \text{ C/kg}$ |
| Faraday constant | F | $9.648 \times 10^4 \text{ C/mol}$ |
| Rydberg constant | R | $1.097 \times 10^7 \text{ m}^{-1}$ |
| Bohr radius | a_0 | $5.292 \times 10^{-11} \text{ m}$ |
| Stefan-Boltzmann constant | σ | $5.670 \times 10^{-8} \text{ W m}^{-2} \text{ K}^{-4}$ |
| Wien's Constant | b | $2.898 \times 10^{-3} \text{ m K}$ |
| Permittivity of free space | ϵ_0 | $8.854 \times 10^{-12} \text{ C}^2 \text{ N}^{-1} \text{ m}^{-2}$ |
| | $1/4\pi\epsilon_0$ | $8.987 \times 10^9 \text{ N m}^2 \text{ C}^{-2}$ |
| Permeability of free space | μ_0 | $4\pi \times 10^{-7} \text{ T m A}^{-1}$ $\cong 1.257 \times 10^{-6} \text{ Wb A}^{-1} \text{ m}^{-1}$ |

Other useful constants

| Name | Symbol | Value |
|--|------------------|------------------------------------|
| Mechanical equivalent of heat | J | 4.186 J cal^{-1} |
| Standard atmospheric pressure | 1 atm | $1.013 \times 10^5 \text{ Pa}$ |
| Absolute zero | 0 K | $-273.15 \text{ }^\circ\text{C}$ |
| Electron volt | 1 eV | $1.602 \times 10^{-19} \text{ J}$ |
| Unified Atomic mass unit | 1 u | $1.661 \times 10^{-27} \text{ kg}$ |
| Electron rest energy | mc^2 | 0.511 MeV |
| Energy equivalent of 1 u | $1 \text{ u}c^2$ | 931.5 MeV |
| Volume of ideal gas(0 °C and 1atm) | V | 22.4 L mol^{-1} |
| Acceleration due to gravity (sea level, at equator) | g | 9.78049 m s^{-2} |

APPENDIX A 4 CONVERSION FACTORS

Conversion factors are written as equations for simplicity.

Length

$$1 \text{ km} = 0.6215 \text{ mi}$$

$$1 \text{ mi} = 1.609 \text{ km}$$

$$1 \text{ m} = 1.0936 \text{ yd} = 3.281 \text{ ft} = 39.37 \text{ in}$$

$$1 \text{ in} = 2.54 \text{ cm}$$

$$1 \text{ ft} = 12 \text{ in} = 30.48 \text{ cm}$$

$$1 \text{ yd} = 3 \text{ ft} = 91.44 \text{ cm}$$

$$1 \text{ lightyear} = 1 \text{ ly} = 9.461 \times 10^{15} \text{ m}$$

$$1 \text{ \AA} = 0.1 \text{ nm}$$

Area

$$1 \text{ m}^2 = 10^4 \text{ cm}^2$$

$$1 \text{ km}^2 = 0.3861 \text{ mi}^2 = 247.1 \text{ acres}$$

$$1 \text{ in}^2 = 6.4516 \text{ cm}^2$$

$$1 \text{ ft}^2 = 9.29 \times 10^{-2} \text{ m}^2$$

$$1 \text{ m}^2 = 10.76 \text{ ft}^2$$

$$1 \text{ acre} = 43,560 \text{ ft}^2$$

$$1 \text{ mi}^2 = 460 \text{ acres} = 2.590 \text{ km}^2$$

Volume

$$1 \text{ m}^3 = 10^6 \text{ cm}^3$$

$$1 \text{ L} = 1000 \text{ cm}^3 = 10^{-3} \text{ m}^3$$

$$1 \text{ gal} = 3.786 \text{ L}$$

$$1 \text{ gal} = 4 \text{ qt} = 8 \text{ pt} = 128 \text{ oz} = 231 \text{ in}^3$$

$$1 \text{ in}^3 = 16.39 \text{ cm}^3$$

$$1 \text{ ft}^3 = 1728 \text{ in}^3 = 28.32 \text{ L} = 2.832 \times 10^4 \text{ cm}^3$$

Speed

$$1 \text{ km h}^{-1} = 0.2778 \text{ m s}^{-1} = 0.6215 \text{ mi h}^{-1}$$

$$1 \text{ mi h}^{-1} = 0.4470 \text{ m s}^{-1} = 1.609 \text{ km h}^{-1}$$

$$1 \text{ mi h}^{-1} = 1.467 \text{ ft s}^{-1}$$

Magnetic Field

$$1 \text{ G} = 10^{-4} \text{ T}$$

$$1 \text{ T} = 1 \text{ Wb m}^{-2} = 10^4 \text{ G}$$

Angle and Angular Speed

$$\pi \text{ rad} = 180^\circ$$

$$1 \text{ rad} = 57.30^\circ$$

$$1^\circ = 1.745 \times 10^{-2} \text{ rad}$$

$$1 \text{ rev min}^{-1} = 0.1047 \text{ rad s}^{-1}$$

$$1 \text{ rad s}^{-1} = 9.549 \text{ rev min}^{-1}$$

Mass

$$1 \text{ kg} = 1000 \text{ g}$$

$$1 \text{ tonne} = 1000 \text{ kg} = 1 \text{ Mg}$$

$$1 \text{ u} = 1.6606 \times 10^{-27} \text{ kg}$$

$$1 \text{ kg} = 6.022 \times 10^{26} \text{ u}$$

$$1 \text{ slug} = 14.59 \text{ kg}$$

$$1 \text{ kg} = 6.852 \times 10^{-2} \text{ slug}$$

$$1 \text{ u} = 931.50 \text{ MeV}/c^2$$

Density

$$1 \text{ g cm}^{-3} = 1000 \text{ kg m}^{-3} = 1 \text{ kg L}^{-1}$$

Force

$$1 \text{ N} = 0.2248 \text{ lbf} = 10^5 \text{ dyn}$$

$$1 \text{ lbf} = 4.4482 \text{ N}$$

$$1 \text{ kgf} = 2.2046 \text{ lbf}$$

Time

$$1 \text{ h} = 60 \text{ min} = 3.6 \text{ ks}$$

$$1 \text{ d} = 24 \text{ h} = 1440 \text{ min} = 86.4 \text{ ks}$$

$$1 \text{ y} = 365.24 \text{ d} = 31.56 \text{ Ms}$$

Pressure

$$1 \text{ Pa} = 1 \text{ N m}^{-2}$$

$$1 \text{ bar} = 100 \text{ kPa}$$

$$1 \text{ atm} = 101.325 \text{ kPa} = 1.01325 \text{ bar}$$

$$1 \text{ atm} = 14.7 \text{ lbf/in}^2 = 760 \text{ mm Hg}$$

$$= 29.9 \text{ in Hg} = 33.8 \text{ ft H}_2\text{O}$$

$$1 \text{ lbf in}^{-2} = 6.895 \text{ kPa}$$

$$1 \text{ torr} = 1 \text{ mm Hg} = 133.32 \text{ Pa}$$

Energy

1 kW h = 3.6 MJ

1 cal = 4.186 J

1 ft lbf = 1.356 J = 1.286×10^{-3} Btu

1 L atm = 101.325 J

1 L atm = 24.217 cal

1 Btu = 778 ft lb = 252 cal = 1054.35 J

1 eV = 1.602×10^{-19} J

1 u c^2 = 931.50 MeV

1 erg = 10^{-7} J

Power

1 horsepower (hp) = 550 ft lbf/s
= 745.7 W

1 Btu min⁻¹ = 17.58 W

1 W = 1.341×10^{-3} hp
= 0.7376 ft lbf/s

Thermal Conductivity

1 W m⁻¹ K⁻¹ = 6.938 Btu in/hft² °F

1 Btu in/hft² °F = 0.1441 W/m K

**APPENDIX A 5
MATHEMATICAL FORMULAE****Geometry**Circle of radius r : circumference = $2\pi r$;

area = πr^2

Sphere of radius r : area = $4\pi r^2$;

volume = $\frac{4}{3}\pi r^3$

Right circular cylinder of radius r
and height h : area = $2\pi r^2 + 2\pi r h$;

volume = $\pi r^2 h$;

Triangle of base a and altitude h .

area = $\frac{1}{2} a h$

Quadratic FormulaIf $ax^2 + bx + c = 0$,

then $x = \frac{-b \pm \sqrt{b^2 - 4ac}}{2a}$

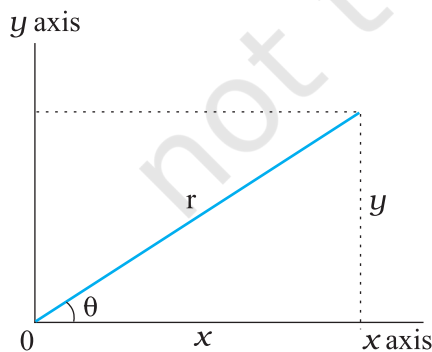
Trigonometric Functions of Angle θ **Fig. A 5.1**

$$\begin{aligned} \sin \theta &= \frac{y}{r} & \cos \theta &= \frac{x}{r} \\ \tan \theta &= \frac{y}{x} & \cot \theta &= \frac{x}{y} \\ \sec \theta &= \frac{r}{x} & \csc \theta &= \frac{r}{y} \end{aligned}$$

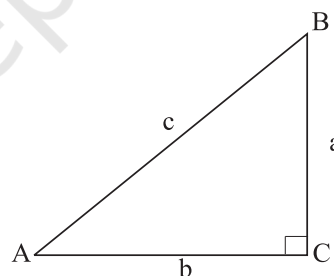
Pythagorean TheoremIn this right triangle, $a^2 + b^2 = c^2$ **Fig. A 5.2****Triangles**Angles are A, B, C Opposite sides are a, b, c Angles $A + B + C = 180^\circ$

$$\frac{\sin A}{a} = \frac{\sin B}{b} = \frac{\sin C}{c}$$

$$c^2 = a^2 + b^2 - 2ab \cos C$$

Exterior angle $D = A + C$

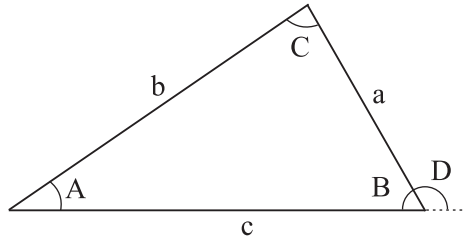

Fig. A 5.3

Mathematical Signs and Symbols

- = equals
- ≅ equals approximately
- ~ is the order of magnitude of
- ≠ is not equal to
- ≡ is identical to, is defined as
- > is greater than (>> is much greater than)
- < is less than (<< is much less than)
- ≥ is greater than or equal to (or, is no less than)
- ≤ is less than or equal to (or, is no more than)
- ± plus or minus
- ∝ is proportional to
- ∑ the sum of
- \bar{x} or $\langle x \rangle$ or x_{av} the average value of x

Trigonometric Identities

$$\begin{aligned} \sin(90^\circ - \theta) &= \cos \theta \\ \cos(90^\circ - \theta) &= \sin \theta \\ \sin \theta / \cos \theta &= \tan \theta \\ \sin^2 \theta + \cos^2 \theta &= 1 \\ \sec^2 \theta - \tan^2 \theta &= 1 \\ \csc^2 \theta - \cot^2 \theta &= 1 \\ \sin 2\theta &= 2 \sin \theta \cos \theta \\ \cos 2\theta &= \cos^2 \theta - \sin^2 \theta = 2\cos^2 \theta - 1 \\ &= 1 - 2\sin^2 \theta \\ \sin(\alpha \pm \beta) &= \sin \alpha \cos \beta \pm \cos \alpha \sin \beta \\ \cos(\alpha \pm \beta) &= \cos \alpha \cos \beta \mp \sin \alpha \sin \beta \\ \tan(\alpha \pm \beta) &= \frac{\tan \alpha \pm \tan \beta}{1 \mp \tan \alpha \tan \beta} \\ \sin \alpha \pm \sin \beta &= 2 \sin \frac{1}{2}(\alpha \pm \beta) \cos \frac{1}{2}(\alpha \mp \beta) \end{aligned}$$

$$\begin{aligned} \cos \alpha + \cos \beta &= 2 \cos \frac{1}{2}(\alpha + \beta) \cos \frac{1}{2}(\alpha - \beta) \\ \cos \alpha - \cos \beta &= -2 \sin \frac{1}{2}(\alpha + \beta) \sin \frac{1}{2}(\alpha - \beta) \end{aligned}$$

Binomial Theorem

$$(1-x)^n = 1 - \frac{nx}{1!} + \frac{n(n-1)x^2}{2!} + \dots (x^2 < 1)$$

$$(1-x)^n = 1 - \frac{nx}{1!} + \frac{n(n+1)x^2}{2!} + \dots (x^2 < 1)$$

Exponential Expansion

$$e^x = 1 + x + \frac{x^2}{2!} + \frac{x^3}{3!} + \dots$$

Logarithmic Expansion

$$\ln(1+x) = x - \frac{1}{2}x^2 + \frac{1}{3}x^3 - \dots (|x| < 1)$$

Trigonometric Expansion

(θ in radians)

$$\begin{aligned} \sin \theta &= \theta - \frac{\theta^3}{3!} + \frac{\theta^5}{5!} - \dots \\ \cos \theta &= 1 - \frac{\theta^2}{2!} + \frac{\theta^4}{4!} - \dots \\ \tan \theta &= \theta + \frac{\theta^3}{3} + \frac{2\theta^5}{15} - \dots \end{aligned}$$

Products of Vectors

Let \hat{i} , \hat{j} and \hat{k} be unit vectors in the x , y and z directions. Then

$$\hat{i} \cdot \hat{i} = \hat{j} \cdot \hat{j} = \hat{k} \cdot \hat{k} = 1, \hat{i} \cdot \hat{j} = \hat{j} \cdot \hat{k} = \hat{k} \cdot \hat{i} = 0$$

$\hat{i} \times \hat{i} = \hat{j} \times \hat{j} = \hat{k} \times \hat{k} = 0, \hat{i} \times \hat{j} = \hat{k}, \hat{j} \times \hat{k} = \hat{i}, \hat{k} \times \hat{i} = \hat{j}$
Any vector \mathbf{a} with components $a_x, a_y,$ and a_z along the $x, y,$ and z axes can be written,

$$\mathbf{a} = a_x \hat{i} + a_y \hat{j} + a_z \hat{k}$$

Let \mathbf{a} , \mathbf{b} and \mathbf{c} be arbitrary vectors with magnitudes a , b and c . Then

$$\mathbf{a} \times (\mathbf{b} + \mathbf{c}) = (\mathbf{a} \times \mathbf{b}) + (\mathbf{a} \times \mathbf{c})$$

$$(\mathbf{sa}) \times \mathbf{b} = \mathbf{a} \times (\mathbf{sb}) = s(\mathbf{a} \times \mathbf{b}) \quad (s \text{ is a scalar})$$

Let θ be the smaller of the two angles between \mathbf{a} and \mathbf{b} . Then

$$\mathbf{a} \cdot \mathbf{b} = \mathbf{b} \cdot \mathbf{a} = a_x b_x + a_y b_y + a_z b_z = ab \cos \theta$$

$$|\mathbf{a} \times \mathbf{b}| = ab \sin \theta$$

$$\begin{aligned} \mathbf{a} \times \mathbf{b} &= -\mathbf{b} \times \mathbf{a} = \begin{vmatrix} \hat{\mathbf{i}} & \hat{\mathbf{j}} & \hat{\mathbf{k}} \\ a_x & a_y & a_z \\ b_x & b_y & b_z \end{vmatrix} \\ &= (a_y b_z - b_y a_z) \hat{\mathbf{i}} + (a_z b_x - b_z a_x) \hat{\mathbf{j}} + (a_x b_y - b_x a_y) \hat{\mathbf{k}} \\ \mathbf{a} \cdot (\mathbf{b} \times \mathbf{c}) &= \mathbf{b} \cdot (\mathbf{c} \times \mathbf{a}) = \mathbf{c} \cdot (\mathbf{a} \times \mathbf{b}) \\ \mathbf{a} \times (\mathbf{b} \times \mathbf{c}) &= (\mathbf{a} \cdot \mathbf{c}) \mathbf{b} - (\mathbf{a} \cdot \mathbf{b}) \mathbf{c} \end{aligned}$$

APPENDIX A 6 SI DERIVED UNITS

A 6.1 Some SI Derived Units expressed in SI Base Units

| Physical quantity | SI Unit | |
|--|---------------------------|---|
| | Name | Symbol |
| Area | square metre | m ² |
| Volume | cubic metre | m ³ |
| Speed, velocity | metre per second | m/s or m s ⁻¹ |
| Angular velocity | radian per second | rad/s or rad s ⁻¹ |
| Acceleration | metre per second square | m/s ² or m s ⁻² |
| Angular acceleration | radian per second square | rad/s ² or rad s ⁻² |
| Wave number | per metre | m ⁻¹ |
| Density, mass density | kilogram per cubic metre | kg/m ³ or kg m ⁻³ |
| Current density | ampere per square metre | A/m ² or A m ⁻² |
| Magnetic field strength, magnetic intensity, magnetic moment density | ampere per metre | A/m or A m ⁻¹ |
| Concentration (of amount of substance) | mole per cubic metre | mol/m ³ or mol m ⁻³ |
| Specific volume | cubic metre per kilogram | m ³ /kg or m ³ kg ⁻¹ |
| Luminance, intensity of illumination | candela per square metre | cd/m ² or cd m ⁻² |
| Kinematic viscosity | square metre per second | m ² /s or m ² s ⁻¹ |
| Momentum | kilogram metre per second | kg m s ⁻¹ |
| Moment of inertia | kilogram square metre | kg m ² |
| Radius of gyration | metre | m |
| Linear/superficial/volume expansivities | per kelvin | K ⁻¹ |
| Flow rate | cubic metre per second | m ³ s ⁻¹ |

A 6.2 SI Derived Units with special names

| Physical quantity | SI Unit | | | |
|---|-----------|----------|------------------------------------|---|
| | Name | Symbol | Expression in terms of other units | Expression in terms of SI base Units |
| Frequency | hertz | Hz | - | s^{-1} |
| Force | newton | N | - | $kg\ m\ s^{-2}$ or $kg\ m/s^2$ |
| Pressure, stress | pascal | Pa | N/m^2 or $N\ m^{-2}$ | $kg\ m^{-1}\ s^{-2}$ or $kg /s^2\ m$ |
| Energy, work, quantity of heat | joule | J | N m | $kg\ m^2\ s^{-2}$ or $kg\ m^2/s^2$ |
| Power, radiant flux | watt | W | J/s or $J\ s^{-1}$ | $kg\ m^2\ s^{-3}$ or $kg\ m^2/s^3$ |
| Quantity of electricity, electric charge | coulomb | C | - | A s |
| Electric potential, potential difference, electromotive force | volt | V | W/A or $W\ A^{-1}$ | $kg\ m^2\ s^{-3}\ A^{-1}$ or $kg\ m^2/s^3\ A$ |
| Capacitance | farad | F | C/V | $A^2\ s^4\ kg^{-1}\ m^{-2}$ |
| Electric resistance | ohm | Ω | V/A | $kg\ m^2\ s^{-3}\ A^{-2}$ |
| Conductance | siemens | S | A/V | $m^{-2}\ kg^{-1}\ s^3\ A^2$ |
| Magnetic flux | weber | Wb | V s or J/A | $kg\ m^2\ s^{-2}\ A^{-1}$ |
| Magnetic field, magnetic flux density, magnetic induction | tesla | T | Wb/ m^2 | $kg\ s^{-2}\ A^{-1}$ |
| Inductance | henry | H | Wb/A | $kg\ m^2\ s^{-2}\ A^{-2}$ |
| Luminous flux, luminous power | lumen | lm | - | cd /sr |
| Illuminance | lux | lx | lm/ m^2 | $m^{-2}\ cd\ sr^{-1}$ |
| Activity (of a radio nuclide/radioactive source) | becquerel | Bq | - | s^{-1} |
| Absorbed dose, absorbed dose index | gray | Gy | J/kg | m^2/s^2 or $m^2\ s^{-2}$ |

A 6.3 Some SI Derived Units expressed by means of SI Units with special names

| Physical quantity | SI Unit | | |
|--|---|------------------------------|--------------------------------------|
| | Name | Symbol | Expression in terms of SI base units |
| Magnetic moment | joule per tesla | $J\ T^{-1}$ | $m^2\ A$ |
| Dipole moment | coulomb metre | C m | s A m |
| Dynamic viscosity | poiseulles or pascal second or newton second per square metre | Pl or Pa s or $N\ s\ m^{-2}$ | $m^{-1}\ kg\ s^{-1}$ |
| Torque, couple, moment of force | newton metre | N m | $m^2\ kg\ s^{-2}$ |
| Surface tension | newton per metre | N/m | $kg\ s^{-2}$ |
| Power density, irradiance, heat flux density | watt per square metre | W/ m^2 | $kg\ s^{-3}$ |

| | | | |
|--|---------------------------|-------------------------------------|---|
| Heat capacity, entropy | joule per kelvin | J/K | $\text{m}^2 \text{kg s}^{-2} \text{K}^{-1}$ |
| Specific heat capacity, specific entropy | joule per kilogram kelvin | J/kg K | $\text{m}^2 \text{s}^{-2} \text{K}^{-1}$ |
| Specific energy, latent heat | joule per kilogram | J/kg | $\text{m}^2 \text{s}^{-2}$ |
| Radiant intensity | watt per steradian | W sr^{-1} | $\text{kg m}^2 \text{s}^{-3} \text{sr}^{-1}$ |
| Thermal conductivity | watt per metre kelvin | $\text{W m}^{-1} \text{K}^{-1}$ | $\text{m kg s}^{-3} \text{K}^{-1}$ |
| Energy density | joule per cubic metre | J/m^3 | $\text{kg m}^{-1} \text{s}^{-2}$ |
| Electric field strength | volt per metre | V/m | $\text{m kg s}^{-3} \text{A}^{-1}$ |
| Electric charge density | coulomb per cubic metre | C/m^3 | $\text{m}^{-3} \text{A s}$ |
| Electric flux density | coulomb per square metre | C/m^2 | $\text{m}^{-2} \text{A s}$ |
| Permittivity | farad per metre | F/m | $\text{m}^{-3} \text{kg}^{-1} \text{s}^4 \text{A}^2$ |
| Permeability | henry per metre | H/m | $\text{m kg s}^{-2} \text{A}^{-2}$ |
| Molar energy | joule per mole | J/mol | $\text{m}^2 \text{kg s}^{-2} \text{mol}^{-1}$ |
| Angular momentum, Planck's constant | joule second | J s | $\text{kg m}^2 \text{s}^{-1}$ |
| Molar entropy, molar heat capacity | joule per mole kelvin | J/mol K | $\text{m}^2 \text{kg s}^{-2} \text{K}^{-1} \text{mol}^{-1}$ |
| Exposure (x-rays and γ -rays) | coulomb per kilogram | C/kg | $\text{kg}^{-1} \text{s A}$ |
| Absorbed dose rate | gray per second | Gy/s | $\text{m}^2 \text{s}^{-3}$ |
| Compressibility | per pascal | Pa^{-1} | $\text{m kg}^{-1} \text{s}^2$ |
| Elastic moduli | newton per square metre | N/m^2 or N m^{-2} | $\text{kg m}^{-1} \text{s}^{-2}$ |
| Pressure gradient | pascal per metre | Pa/m or N m^{-3} | $\text{kg m}^{-2} \text{s}^{-2}$ |
| Surface potential | joule per kilogram | J/kg or N m/kg | $\text{m}^2 \text{s}^{-2}$ |
| Pressure energy | pascal cubic metre | Pa m^3 or N m | $\text{kg m}^2 \text{s}^{-2}$ |
| Impulse | newton second | N s | kg m s^{-1} |
| Angular impulse | newton metre second | N m s | $\text{kg m}^2 \text{s}^{-1}$ |
| Specific resistance | ohm metre | Ωm | $\text{kg m}^3 \text{s}^{-3} \text{A}^{-2}$ |
| Surface energy | joule per square metre | J/m^2 or N/m | kg s^{-2} |

APPENDIX A 7

GENERAL GUIDELINES FOR USING SYMBOLS FOR PHYSICAL QUANTITIES, CHEMICAL ELEMENTS AND NUCLIDES

- Symbols for physical quantities are normally single letters and printed in italic (or sloping) type. However, in case of the two letter symbols, appearing as a factor in a product, some spacing is necessary to separate this symbol from other symbols.
- Abbreviations, i.e., shortened forms of names or expressions, such as p.e. for potential energy, are not used in physical equations. These abbreviations in the text are written in ordinary normal/roman (upright) type.
- Vectors are printed in bold and normal/roman (upright) type. However, in class room situations, vectors may be indicated by an arrow on the top of the symbol.
- Multiplication or product of two physical quantities is written with some spacing between them. Division of one physical quantity by another may be indicated with a horizontal bar or with

solidus, a slash or a short oblique stroke mark (/) or by writing it as a product of the numerator and the inverse first power of the denominator, using brackets at appropriate places to clearly distinguish between the numerator and the denominator.

- Symbols for chemical elements are written in normal/roman (upright) type. The symbol is not followed by a full stop.

For example, Ca, C, H, He, U, etc.

- The attached numerals specifying a nuclide are placed as a left subscript (atomic number) and superscript (mass number).

For example, a U-235 nuclide is expressed as ${}_{92}^{235}\text{U}$ (with 235 expressing the mass number and 92 as the atomic number of uranium with chemical symbol U).

- The right superscript position is used, if required, for indicating a state of ionisation (in case of ions).

For example, Ca^{2+} , PO_4^{3-}

APPENDIX A 8

GENERAL GUIDELINES FOR USING SYMBOLS FOR SI UNITS, SOME OTHER UNITS, AND SI PREFIXES

- Symbols for units of physical quantities are printed/written in Normal/Roman (upright) type.
- Standard and recommended symbols for units are written in lower case roman (upright) type, starting with small letters. The shorter designations for units such as kg, m, s, cd, etc., are symbols and not the abbreviations. The unit names are never capitalised. However, the unit symbols are capitalised only if the symbol for a unit is derived from a proper name of scientist, beginning with a capital, normal/roman letter.

For example, m for the unit 'metre', d for the unit 'day', atm for the unit 'atmospheric pressure', Hz for the unit 'hertz', Wb for the unit 'weber', J for the unit 'joule', A for the unit 'ampere', V for the unit 'volt', etc. The single exception is L, which is the symbol for the unit 'litre'. This exception is made to avoid confusion of the lower case letter l with the Arabic numeral 1.

- Symbols for units do not contain any final full stop at the end of recommended letter and remain unaltered in the plural, using only singular form of the unit.

For example, for a length of 25 centimetres the unit symbol is written as 25 cm and not 25 cms or 25 cm. or 25 cms., etc.

- Use of solidus (/) is recommended only for indicating a division of one letter unit symbol by another unit symbol. Not more than one solidus is used.

For example :

m/s^2 or m s^{-2} (with a spacing between m and s^{-2}) but not m/s/s ;

$1 \text{ Pl} = 1 \text{ N s m}^{-2} = 1 \text{ N s/m}^2 = 1 \text{ kg/s m} = 1 \text{ kg m}^{-1} \text{ s}^{-1}$, but not 1 kg/m/s ;

J/K mol or $\text{J K}^{-1} \text{ mol}^{-1}$, but not J/K/mol ; etc.

- Prefix symbols are printed in normal/roman (upright) type without spacing between the prefix symbol and the unit symbol. Thus certain approved prefixes written very close to the unit symbol are used to indicate decimal fractions or multiples of a SI unit, when it is inconveniently small or large.

For example :

megawatt (1 MW = 10^6 W);

centimetre (1 cm = 10^{-2} m);

kilometre (1 km = 10^3 m);

millivolt (1 mV = 10^{-3} V);

nanosecond (1 ns = 10^{-9} s);

picofarad (1 pF = 10^{-12} F);

microsecond (1 μs = 10^{-6} s);

gigahertz (1 GHz = 10^9 Hz);

kilowatt-hour ($1 \text{ kW h} = 10^3 \text{ W h} = 3.6 \text{ MJ} = 3.6 \times 10^6 \text{ J}$);
 microampere ($1 \mu\text{A} = 10^{-6} \text{ A}$); micron ($1 \mu\text{m} = 10^{-6} \text{ m}$);
 angstrom ($1 \text{ \AA} = 0.1 \text{ nm} = 10^{-10} \text{ m}$); etc.

The unit 'micron' which equals 10^{-6} m , i.e. a micrometre, is simply the name given to convenient sub-multiple of the metre. In the same spirit, the unit 'fermi', equal to a femtometre or 10^{-15} m has been used as the convenient length unit in nuclear studies. Similarly, the unit 'barn', equal to 10^{-28} m^2 , is a convenient measure of cross-sectional areas in sub-atomic particle collisions. However, the unit 'micron' is preferred over the unit 'micrometre' to avoid confusion of the 'micrometre' with the length measuring instrument called 'micrometer'. These newly formed multiples or sub-multiples (cm, km, μm , μs , ns) of SI units, metre and second, constitute a new composite inseparable symbol for units.

- When a prefix is placed before the symbol of a unit, the combination of prefix and symbol is considered as a new symbol, for the unit, which can be raised to a positive or negative power without using brackets. These can be combined with other unit symbols to form compound unit. Rules for binding-in indices are not those of ordinary algebra.

For example :

cm^3 means always $(\text{cm})^3 = (0.01 \text{ m})^3 = (10^{-2} \text{ m})^3 = 10^{-6} \text{ m}^3$, but never 0.01 m^3 or 10^{-2} m^3 or 1 cm^3 (prefix c with a spacing with m^3 is meaningless as prefix c is to be attached to a unit symbol and it has no physical significance or independent existence without attachment with a unit symbol).

Similarly, mA^2 means always $(\text{mA})^2 = (0.001 \text{ A})^2 = (10^{-3} \text{ A})^2 = 10^{-6} \text{ A}^2$, but never 0.001 A^2 or 10^{-3} A^2 or mA^2 ;

$1 \text{ cm}^{-1} = (10^{-2} \text{ m})^{-1} = 10^2 \text{ m}^{-1}$, but not 1 c m^{-1} or 10^{-2} m^{-1} ;

$1 \mu\text{s}^{-1}$ means always $(10^{-6} \text{ s})^{-1} = 10^6 \text{ s}^{-1}$, but not $1 \times 10^{-6} \text{ s}^{-1}$;

1 km^2 means always $(\text{km})^2 = (10^3 \text{ m})^2 = 10^6 \text{ m}^2$, but not 10^3 m^2 ;

1 mm^2 means always $(\text{mm})^2 = (10^{-3} \text{ m})^2 = 10^{-6} \text{ m}^2$, but not 10^{-3} m^2 .

- A prefix is never used alone. It is always attached to a unit symbol and written or fixed before (pre-fix) the unit symbol.

For example :

$10^3/\text{m}^3$ means $1000/\text{m}^3$ or 1000 m^{-3} , but not k/m^3 or k m^{-3} .

$10^6/\text{m}^3$ means $10,00,000/\text{m}^3$ or $10,00,000 \text{ m}^{-3}$, but not M/m^3 or M m^{-3}

- Prefix symbol is written very close to the unit symbol without spacing between them, while unit symbols are written separately with spacing when units are multiplied together.

For example :

m s^{-1} (symbols m and s^{-1} , in lower case, small letter m and s, are separate and independent unit symbols for metre and second respectively, with spacing between them) means 'metre per second', but not 'milli per second'.

Similarly, ms^{-1} [symbol m and s are written very close to each other, with prefix symbol m (for prefix milli) and unit symbol s, in lower case, small letter (for unit 'second') without any spacing between them and making ms as a new composite unit] means 'per millisecond', but never 'metre per second'.

mS^{-1} [symbol m and S are written very close to each other, with prefix symbol m (for prefix milli) and unit symbol S, in capital roman letter S (for unit 'siemens') without any spacing between them, and making mS as a new composite unit] means 'per millisiemens', but never 'per millisecond'.

C m [symbol C and m are written separately, representing unit symbols C (for unit 'coulomb') and m (for unit 'metre'), with spacing between them] means 'coulomb metre', but never 'centimetre', etc.

- The use of double prefixes is avoided when single prefixes are available.

For example :

- $10^{-9} \text{ m} = 1 \text{ nm}$ (nanometre), but not $1 \text{ m}\mu\text{m}$ (millimicrometre),
 $10^{-6} \text{ m} = 1 \mu\text{m}$ (micron), but not 1 mmm (millimillimetre),
 $10^{-12} \text{ F} = 1 \text{ pF}$ (picofarad), but not $1 \mu\mu\text{F}$ (micromicrofarad),
 $10^9 \text{ W} = 1 \text{ GW}$ (giga watt), but not 1 kMW (kilomegawatt), etc.
- The use of a combination of unit and the symbols for units is avoided when the physical quantity is expressed by combining two or more units.
 For example :
 joule per mole kelvin is written as J/mol K or $\text{J mol}^{-1} \text{ K}^{-1}$, but not joule/mole K or J/ mol kelvin or J/mole K, etc.
 joule per tesla is written as J/T or J T^{-1} , but not joule /T or J per tesla or J/tesla, etc.
 newton metre second is written as N m s , but not Newton m second or N m second or N metre s or newton metre s, etc.
 joule per kilogram kelvin is written as J/kg K or $\text{J kg}^{-1} \text{ K}^{-1}$, but not J/kilog K or joule/kg K or J/ kg kelvin or J/kilogram K, etc.
 - To simplify calculations, the prefix symbol is attached to the unit symbol in the numerator and not to the denominator.
 For example :
 10^6 N/m^2 is written more conveniently as MN/m^2 , in preference to N/mm^2 .
 A preference has been expressed for multiples or sub-multiples involving the factor 1000, $10^{\pm 3n}$ where n is the integer.
 - Proper care is needed when same symbols are used for physical quantities and units of physical quantities.
 For example :
 The physical quantity weight (W) expressed as a product of mass (m) and acceleration due to gravity (g) may be written in terms of symbols W , m and g printed in italic (or sloping) type as $W = m g$, preferably with a spacing between m and g . It should not be confused with the unit symbols for the units watt (W), metre (m) and gram (g). However, in the equation $W = m g$, the symbol W expresses the weight with a unit symbol J, m as the mass with a unit symbol kg and g as the acceleration due to gravity with a unit symbol m/s^2 . Similarly, in equation $F = m a$, the symbol F expresses the force with a unit symbol N, m as the mass with a unit symbol kg, and a as the acceleration with a unit symbol m/s^2 . These symbols for physical quantities should not be confused with the unit symbols for the units 'farad' (F), 'metre' (m) and 'are' (a).
 Proper distinction must be made while using the symbols h (prefix hecto, and unit hour), c (prefix centi, and unit carat), d (prefix deci and unit day), T (prefix tera, and unit tesla), a (prefix atto, and unit are), da (prefix deca, and unit deciare), etc.
 - SI base unit 'kilogram' for mass is formed by attaching SI prefix (a multiple equal to 10^3) 'kilo' to a cgs (centimetre, gram, second) unit 'gram' and this may seem to result in an anomaly. Thus, while a thousandth part of unit of length (metre) is called a millimetre (mm), a thousandth part of the unit of mass (kg) is not called a millikilogram, but just a gram. This appears to give the impression that the unit of mass is a gram (g) which is not true. Such a situation has arisen because we are unable to replace the name 'kilogram' by any other suitable unit. Therefore, as an exception, name of the multiples and sub-multiples of the unit of mass are formed by attaching prefixes to the word 'gram' and not to the word 'kilogram'.
 For example :
 $10^3 \text{ kg} = 1 \text{ megagram (1 Mg)}$, but not 1 kilo kilogram (1 kkg);
 $10^{-6} \text{ kg} = 1 \text{ milligram (1 mg)}$, but not 1 microkilogram (1 μkg);
 $10^{-3} \text{ kg} = 1 \text{ gram (1g)}$, but not 1 millikilogram (1 mkg), etc.

It may be emphasised again that you should use the internationally approved and recommended symbols only. Continual practice of following general rules and guidelines in unit symbol writing would make you learn mastering the correct use of SI units, prefixes and related symbols for physical quantities in a proper perspective.

APPENDIX A 9
DIMENSIONAL FORMULAE OF PHYSICAL QUANTITIES

| S.No | Physical quantity | Relationship with other physical quantities | Dimensions | Dimensional formula |
|------|---|--|--|---------------------|
| 1. | Area | Length \times breadth | $[L^2]$ | $[M^0 L^2 T^0]$ |
| 2. | Volume | Length \times breadth \times height | $[L^3]$ | $[M^0 L^3 T^0]$ |
| 3. | Mass density | Mass/volume | $[M]/[L^3]$ or $[M L^{-3}]$ | $[M L^{-3} T^0]$ |
| 4. | Frequency | 1/time period | $1/[T]$ | $[M^0 L^0 T^{-1}]$ |
| 5. | Velocity, speed | Displacement/time | $[L]/[T]$ | $[M^0 L T^{-1}]$ |
| 6. | Acceleration | Velocity /time | $[L T^{-1}]/[T]$ | $[M^0 L T^{-2}]$ |
| 7. | Force | Mass \times acceleration | $[M][L T^{-2}]$ | $[M L T^{-2}]$ |
| 8. | Impulse | Force \times time | $[M L T^{-2}][T]$ | $[M L T^{-1}]$ |
| 9. | Work, Energy | Force \times distance | $[M L T^{-2}] [L]$ | $[M L^2 T^{-2}]$ |
| 10. | Power | Work/time | $[M L^2 T^{-2}]/[T]$ | $[M L^2 T^{-3}]$ |
| 11. | Momentum | Mass \times velocity | $[M] [L T^{-1}]$ | $[M L T^{-1}]$ |
| 12. | Pressure, stress | Force/area | $[M L T^{-2}]/[L^2]$ | $[M L^{-1} T^{-2}]$ |
| 13. | Strain | $\frac{\text{Change in dimension}}{\text{Original dimension}}$ | $[L] / [L]$ or $[L^3] / [L^3]$ | $[M^0 L^0 T^0]$ |
| 14. | Modulus of elasticity | Stress/strain | $\frac{[M L^{-1} T^{-2}]}{[M^0 L^0 T^0]}$ | $[M L^{-1} T^{-2}]$ |
| 15. | Surface tension | Force/length | $[M L T^{-2}]/[L]$ | $[M L^0 T^{-2}]$ |
| 16. | Surface energy | Energy/area | $[M L^2 T^{-2}]/[L^2]$ | $[M L^0 T^{-2}]$ |
| 17. | Velocity gradient | Velocity/distance | $[L T^{-1}]/[L]$ | $[M^0 L^0 T^{-1}]$ |
| 18. | Pressure gradient | Pressure/distance | $[M L^{-1} T^{-2}]/[L]$ | $[M L^{-2} T^{-2}]$ |
| 19. | Pressure energy | Pressure \times volume | $[M L^{-1} T^{-2}] [L^3]$ | $[M L^2 T^{-2}]$ |
| 20. | Coefficient of viscosity | Force/area \times velocity gradient | $\frac{[M L T^{-2}]}{[L^2][L T^{-1} / L]}$ | $[M L^{-1} T^{-1}]$ |
| 21. | Angle, Angular displacement | Arc/radius | $[L]/[L]$ | $[M^0 L^0 T^0]$ |
| 22. | Trigonometric ratio (sin θ , cos θ , tan θ , etc.) | Length/length | $[L]/[L]$ | $[M^0 L^0 T^0]$ |
| 23. | Angular velocity | Angle/time | $[L^0]/[T]$ | $[M^0 L^0 T^{-1}]$ |

| | | | | |
|-----|-----------------------------------|---|--|---------------------|
| 24. | Angular acceleration | Angular velocity/time | $[T^{-1}]/[T]$ | $[M^0L^0T^{-2}]$ |
| 25. | Radius of gyration | Distance | $[L]$ | $[M^0LT^0]$ |
| 26. | Moment of inertia | Mass \times (radius of gyration) ² | $[M] [L^2]$ | $[ML^2 T^0]$ |
| 27. | Angular momentum | Moment of inertia \times angular velocity | $[ML^2] [T^{-1}]$ | $[ML^2 T^{-1}]$ |
| 28. | Moment of force, moment of couple | Force \times distance | $[MLT^{-2}] [L]$ | $[ML^2 T^{-2}]$ |
| 29. | Torque | Angular momentum/time, Or Force \times distance | $[ML^2 T^{-1}] / [T]$ or $[MLT^{-2}] [L]$ | $[ML^2 T^{-2}]$ |
| 30. | Angular frequency | $2\pi \times$ Frequency | $[T^{-1}]$ | $[M^0L^0T^{-1}]$ |
| 31. | Wavelength | Distance | $[L]$ | $[M^0LT^0]$ |
| 32. | Hubble constant | Recession speed/distance | $[LT^{-1}]/[L]$ | $[M^0L^0T^{-1}]$ |
| 33. | Intensity of wave | (Energy/time)/area | $[ML^2 T^{-2}]/[L^2]$ | $[ML^0T^{-3}]$ |
| 34. | Radiation pressure | $\frac{\text{Intensity of wave}}{\text{Speed of light}}$ | $[MT^{-3}]/[LT^{-1}]$ | $[ML^{-1} T^{-2}]$ |
| 35. | Energy density | Energy/volume | $[ML^2 T^{-2}] / [L^3]$ | $[ML^{-1} T^{-2}]$ |
| 36. | Critical velocity | $\frac{\text{Reynold's number} \times \text{coefficient of viscosity}}{\text{Mass density} \times \text{radius}}$ | $\frac{[M^0L^0T^0][ML^{-1} T^{-1}]}{[ML^{-3}][L]}$ | $[M^0LT^{-1}]$ |
| 37. | Escape velocity | $(2 \times \text{acceleration due to gravity} \times \text{earth's radius})^{1/2}$ | $[LT^{-2}]^{1/2} \times [L]^{1/2}$ | $[M^0LT^{-1}]$ |
| 38. | Heat energy, internal energy | Work (= Force \times distance) | $[MLT^{-2}] [L]$ | $[ML^2 T^{-2}]$ |
| 39. | Kinetic energy | $(1/2) \text{ mass} \times (\text{velocity})^2$ | $[M] [LT^{-1}]^2$ | $[ML^2 T^{-2}]$ |
| 40. | Potential energy | Mass \times acceleration due to gravity \times height | $[M] [LT^{-2}] [L]$ | $[ML^2 T^{-2}]$ |
| 41. | Rotational kinetic energy | $\frac{1}{2} \times \text{moment of inertia} \times (\text{angular velocity})^2$ | $[M^0L^0T^0] [ML^2] \times [T^{-1}]^2$ | $[ML^2 T^{-2}]$ |
| 42. | Efficiency | $\frac{\text{Output work or energy}}{\text{Input work or energy}}$ | $\frac{[ML^2 T^{-2}]}{[ML^2 T^{-2}]}$ | $[M^0L^0T^0]$ |
| 43. | Angular impulse | Torque \times time | $[ML^2 T^{-2}] [T]$ | $[ML^2 T^{-1}]$ |
| 44. | Gravitational constant | $\frac{\text{Force} \times (\text{distance})^2}{\text{mass} \times \text{mass}}$ | $\frac{[MLT^{-2}][L^2]}{[M] [M]}$ | $[M^{-1}L^3T^{-2}]$ |
| 45. | Planck constant | Energy/frequency | $[ML^2 T^{-2}] / [T^{-1}]$ | $[ML^2 T^{-1}]$ |

| | | | | |
|-----|---|---|--|--|
| 46. | Heat capacity, entropy | Heat energy / temperature | $[ML^2 T^{-2}]/[K]$ | $[ML^2 T^{-2} K^{-1}]$ |
| 47. | Specific heat capacity | $\frac{\text{Heat Energy}}{\text{Mass} \times \text{temperature}}$ | $[ML^2 T^{-2}]/[M] [K]$ | $[M^0 L^2 T^{-2} K^{-1}]$ |
| 48. | Latent heat | Heat energy/mass | $[ML^2 T^{-2}]/[M]$ | $[M^0 L^2 T^{-2}]$ |
| 49. | Thermal expansion coefficient or Thermal expansivity | $\frac{\text{Change in dimension}}{\text{Original dimension} \times \text{temperature}}$ | $[L] / [L][K]$ | $[M^0 L^0 K^{-1}]$ |
| 50. | Thermal conductivity | $\frac{\text{Heat energy} \times \text{thickness}}{\text{Area} \times \text{temperature} \times \text{time}}$ | $\frac{[ML^2 T^{-2}][L]}{[L^2] [K] [T]}$ | $[MLT^{-3} K^{-1}]$ |
| 51. | Bulk modulus or (compressibility) ⁻¹ | $\frac{\text{Volume} \times (\text{change in pressure})}{(\text{change in volume})}$ | $\frac{[L^3] [ML^{-1} T^{-2}]}{[L^3]}$ | $[ML^{-1} T^{-2}]$ |
| 52. | Centripetal acceleration | (Velocity) ² / radius | $[LT^{-1}]^2 / [L]$ | $[M^0 LT^{-2}]$ |
| 53. | Stefan constant | $\frac{(\text{Energy} / \text{area} \times \text{time})}{(\text{Temperature})^4}$ | $\frac{[ML^2 T^{-2}]}{[L^2] [T] [K]^4}$ | $[ML^0 T^{-3} K^{-4}]$ |
| 54. | Wien constant | Wavelength × temperature | $[L] [K]$ | $[M^0 LT^0 K]$ |
| 55. | Boltzmann constant | Energy/temperature | $[ML^2 T^{-2}]/[K]$ | $[ML^2 T^{-2} K^{-1}]$ |
| 56. | Universal gas constant | $\frac{\text{Pressure} \times \text{volume}}{\text{mole} \times \text{temperature}}$ | $\frac{[ML^{-1} T^{-2}][L^3]}{[\text{mol}] [K]}$ | $[ML^2 T^{-2} K^{-1} \text{mol}^{-1}]$ |
| 57. | Charge | Current × time | $[A] [T]$ | $[M^0 L^0 TA]$ |
| 58. | Current density | Current / area | $[A] / [L^2]$ | $[M^0 L^{-2} T^0 A]$ |
| 59. | Voltage, electric potential, electromotive force | Work/charge | $[ML^2 T^{-2}]/[AT]$ | $[ML^2 T^{-3} A^{-1}]$ |
| 60. | Resistance | $\frac{\text{Potential difference}}{\text{Current}}$ | $\frac{[ML^2 T^{-3} A^{-1}]}{[A]}$ | $[ML^2 T^{-3} A^{-2}]$ |
| 61. | Capacitance | Charge/potential difference | $\frac{[AT]}{[ML^2 T^{-3} A^{-1}]}$ | $[M^{-1} L^{-2} T^4 A^2]$ |
| 62. | Electrical resistivity or (electrical conductivity) ⁻¹ | $\frac{\text{Resistance} \times \text{area}}{\text{length}}$ | $\frac{[ML^2 T^{-3} A^{-2}]}{[L^2]/[L]}$ | $[ML^3 T^{-3} A^{-2}]$ |
| 63. | Electric field | Electrical force/charge | $[MLT^{-2}]/[AT]$ | $[MLT^{-3} A^{-1}]$ |
| 64. | Electric flux | Electric field × area | $[MLT^{-3} A^{-1}][L^2]$ | $[ML^3 T^{-3} A^{-1}]$ |

| | | | | |
|-----|--|---|--|---------------------------------|
| 65. | Electric dipole moment | Torque/electric field | $\frac{[ML^2 T^{-2}]}{[MLT^{-3} A^{-1}]}$ | $[M^0 LTA]$ |
| 66. | Electric field strength or electric intensity | $\frac{\text{Potential difference}}{\text{distance}}$ | $\frac{[ML^2 T^{-3} A^{-1}]}{[L]}$ | $[MLT^{-3} A^{-1}]$ |
| 67. | Magnetic field, magnetic flux density, magnetic induction | $\frac{\text{Force}}{\text{Current} \times \text{length}}$ | $[MLT^{-2}]/[A][L]$ | $[ML^0 T^{-2} A^{-1}]$ |
| 68. | Magnetic flux | Magnetic field \times area | $[MT^{-2} A^{-2}][L^2]$ | $[ML^2 T^{-2} A^{-1}]$ |
| 69. | Inductance | $\frac{\text{Magnetic flux}}{\text{Current}}$ | $\frac{[ML^2 T^{-2} A^{-1}]}{[A]}$ | $[ML^2 T^{-2} A^{-2}]$ |
| 70. | Magnetic dipole moment | Torque/magnetic field or current \times area | $[ML^2 T^{-2}]/[MT^{-2} A^{-1}]$ or $[A][L^2]$ | $[M^0 L^2 T^0 A]$ |
| 71. | Magnetic field strength, magnetic intensity or magnetic moment density | $\frac{\text{Magnetic moment}}{\text{Volume}}$ | $\frac{[L^2 A]}{[L^3]}$ | $[M^0 L^{-1} T^0 A]$ |
| 72. | Permittivity constant (of free space) | $\frac{\text{Charge} \times \text{charge}}{4\pi \times \text{electric force} \times (\text{distance})^2}$ | $\frac{[AT][AT]}{[MLT^{-2}][L]^2}$ | $[M^{-1} L^{-3} T^4 A^2]$ |
| 73. | Permeability constant (of free space) | $\frac{2\pi \times \text{force} \times \text{distance}}{\text{current} \times \text{current} \times \text{length}}$ | $\frac{[M^0 L^0 T^0][MLT^{-2}][L]}{[A][A][L]}$ | $[MLT^{-2} A^{-2}]$ |
| 74. | Refractive index | $\frac{\text{Speed of light in vacuum}}{\text{Speed of light in medium}}$ | $[LT^{-1}]/[LT^{-1}]$ | $[M^0 L^0 T^0]$ |
| 75. | Faraday constant | Avogadro constant \times elementary charge | $[AT]/[\text{mol}]$ | $[M^0 L^0 TA \text{ mol}^{-1}]$ |
| 76. | Wave number | $2\pi/\text{wavelength}$ | $[M^0 L^0 T^0]/[L]$ | $[M^0 L^{-1} T^0]$ |
| 77. | Radiant flux, Radiant power | Energy emitted/time | $[ML^2 T^{-2}]/[T]$ | $[ML^2 T^{-3}]$ |
| 78. | Luminosity of radiant flux or radiant intensity | $\frac{\text{Radiant power or radiant flux of source}}{\text{Solid angle}}$ | $[ML^2 T^{-3}]/[M^0 L^0 T^0]$ | $[ML^2 T^{-3}]$ |
| 79. | Luminous power or luminous flux of source | $\frac{\text{Luminous energy emitted}}{\text{time}}$ | $[ML^2 T^{-2}]/[T]$ | $[ML^2 T^{-3}]$ |

| | | | | |
|-----|--|--|---|--|
| 80. | Luminous intensity or illuminating power of source | $\frac{\text{Luminous flux}}{\text{Solid angle}}$ | $\frac{[\text{ML}^2 \text{T}^{-3}]}{[\text{M}^0 \text{L}^0 \text{T}^0]}$ | $[\text{ML}^2 \text{T}^{-3}]$ |
| 81. | Intensity of illumination or luminance | $\frac{\text{Luminous intensity}}{(\text{distance})^2}$ | $[\text{ML}^2 \text{T}^{-3}]/[\text{L}^2]$ | $[\text{ML}^0 \text{T}^{-3}]$ |
| 82. | Relative luminosity | $\frac{\text{Luminous flux of a source of given wavelength}}{\text{luminous flux of peak sensitivity wavelength (555 nm) source of same power}}$ | $\frac{[\text{ML}^2 \text{T}^{-1}]}{[\text{ML}^2 \text{T}^{-3}]}$ | $[\text{M}^0 \text{L}^0 \text{T}^0]$ |
| 83. | Luminous efficiency | $\frac{\text{Total luminous flux}}{\text{Total radiant flux}}$ | $[\text{ML}^2 \text{T}^{-3}] / [\text{ML}^2 \text{T}^{-3}]$ | $[\text{M}^0 \text{L}^0 \text{T}^0]$ |
| 84. | Illuminance or illumination | $\frac{\text{Luminous flux incident}}{\text{area}}$ | $[\text{ML}^2 \text{T}^{-3}]/[\text{L}^2]$ | $[\text{ML}^0 \text{T}^{-3}]$ |
| 85. | Mass defect | (sum of masses of nucleons)-(mass of the nucleus) | [M] | $[\text{ML}^0 \text{T}^0]$ |
| 86. | Binding energy of nucleus | Mass defect \times (speed of light in vacuum) ² | [M] [L T ⁻¹] ² | $[\text{ML}^2 \text{T}^{-2}]$ |
| 87. | Decay constant | 0.693/half life | [T ⁻¹] | $[\text{M}^0 \text{L}^0 \text{T}^{-1}]$ |
| 88. | Resonant frequency | $(\text{Inductance} \times \text{capacitance})^{-\frac{1}{2}}$ | $[\text{ML}^2 \text{T}^{-2} \text{A}^{-2}]^{-\frac{1}{2}} \times$ $[\text{M}^{-1} \text{L}^{-2} \text{T}^4 \text{A}^2]^{-\frac{1}{2}}$ | $[\text{M}^0 \text{L}^0 \text{A}^0 \text{T}^{-1}]$ |
| 89. | Quality factor or Q-factor of coil | $\frac{\text{Resonant frequency} \times \text{inductance}}{\text{Resistance}}$ | $\frac{[\text{T}^{-1}][\text{ML}^2 \text{T}^{-2} \text{A}^{-2}]}{[\text{ML}^2 \text{T}^{-3} \text{A}^{-2}]}$ | $[\text{M}^0 \text{L}^0 \text{T}^0]$ |
| 90. | Power of lens | (Focal length) ⁻¹ | [L ⁻¹] | $[\text{M}^0 \text{L}^{-1} \text{T}^0]$ |
| 91. | Magnification | $\frac{\text{Image distance}}{\text{Object distance}}$ | [L] / [L] | $[\text{M}^0 \text{L}^0 \text{T}^0]$ |
| 92. | Fluid flow rate | $\frac{(\pi/8) (\text{pressure}) \times (\text{radius})^4}{(\text{viscosity coefficient}) \times (\text{length})}$ | $\frac{[\text{ML}^{-1} \text{T}^{-2}] [\text{L}^4]}{[\text{ML}^{-1} \text{T}^{-1}] [\text{L}]}$ | $[\text{M}^0 \text{L}^3 \text{T}^{-1}]$ |
| 93. | Capacitive reactance | (Angular frequency \times capacitance) ⁻¹ | $[\text{T}^{-1}]^{-1} [\text{M}^{-1} \text{L}^{-2} \text{T}^4 \text{A}^2]^{-1}$ | $[\text{ML}^2 \text{T}^{-3} \text{A}^{-2}]$ |
| 94. | Inductive reactance | (Angular frequency \times inductance) | $[\text{T}^{-1}][\text{ML}^2 \text{T}^{-2} \text{A}^{-2}]$ | $[\text{ML}^2 \text{T}^{-3} \text{A}^{-2}]$ |

ANSWERS

Chapter 1

- 1.1** (a) 10^{-6} ; (b) 1.5×10^4 ; (c) 5; (d) 11.3, 1.13×10^4 .
- 1.2** (a) 10^7 ; (b) 10^{-16} ; (c) 3.9×10^4 ; (d) 6.67×10^{-8} .
- 1.5** 500
- 1.6** (c)
- 1.7** 0.035 mm
- 1.9** 94.1
- 1.10** (a) 1; (b) 3; (c) 4; (d) 4; (e) 4; (f) 4.
- 1.11** 8.72 m^2 ; 0.0855 m^3
- 1.12** (a) 2.3 kg; (b) 0.02 g
- 1.13** The correct formula is $m = m_0(1 - v^2/c^2)^{-1/2}$
- 1.14** $\cong 3 \times 10^{-7} \text{ m}^3$
- 1.15** $\cong 10^4$; intermolecular separation in a gas is much larger than the size of a molecule.
- 1.16** Near objects make greater angle than distant (far off) objects at the eye of the observer. When you are moving, the angular change is less for distant objects than nearer objects. So, these distant objects seem to move along with you, but the nearer objects in opposite direction.
- 1.17** $1.4 \times 10^3 \text{ kg m}^{-3}$; the mass density of the Sun is in the range of densities of liquids / solids and *not* gases. This high density arises due to inward gravitational attraction on outer layers due to inner layers of the Sun.

Chapter 2

- 2.1** (a), (b)
- 2.2** (a) A....B, (b) A....B, (c) B....A, (d) Same, (e) B....A....once.
- 2.4** 37 s
- 2.5** 3.06 m s^{-2} ; 11.4 s

- 2.6** (a) Vertically downwards; (b) zero velocity, acceleration of 9.8 m s^{-2} downwards; (c) $x > 0$ (upward and downward motion); $v < 0$ (upward), $v > 0$ (downward), $a > 0$ throughout; (d) 44.1 m, 6 s.
- 2.7** (a) True; (b) False; (c) True (if the particle rebounds instantly with the same speed, it implies infinite acceleration which is unphysical); (d) False (true only when the chosen positive direction is along the direction of motion)
- 2.10** (a) 5 km h^{-1} , 5 km h^{-1} ; (b) 0, 6 km h^{-1} ; (c) $\frac{15}{8} \text{ km h}^{-1}$, $\frac{45}{8} \text{ km h}^{-1}$
- 2.11** Because, for an arbitrarily small interval of time, the magnitude of displacement is equal to the length of the path.
- 2.12** All the four graphs are impossible. (a) a particle cannot have two different positions at the same time; (b) a particle cannot have velocity in opposite directions at the same time; (c) speed is always non-negative; (d) total path length of a particle can never decrease with time. (Note, the arrows on the graphs are meaningless).
- 2.13** No, wrong. $x-t$ plot does not show the trajectory of a particle. Context: A body is dropped from a tower ($x = 0$) at $t = 0$.
- 2.14** 105 m s^{-1}
- 2.15** (a) A ball at rest on a smooth floor is kicked, it rebounds from a wall with reduced speed and moves to the opposite wall which stops it; (b) A ball thrown up with some initial velocity rebounding from the floor with reduced speed after each hit; (c) A uniformly moving cricket ball turned back by hitting it with a bat for a very short time-interval.
- 2.16** $x < 0$, $v < 0$, $a > 0$; $x > 0$, $v > 0$, $a < 0$; $x < 0$, $v > 0$, $a > 0$.
- 2.17** Greatest in 3, least in 2; $v > 0$ in 1 and 2, $v < 0$ in 3.
- 2.18** Acceleration magnitude greatest in 2; speed greatest in 3; $v > 0$ in 1, 2 and 3; $a > 0$ in 1 and 3, $a < 0$ in 2; $a = 0$ at A, B, C, D.

Chapter 3

- 3.1** Volume, mass, speed, density, number of moles, angular frequency are scalars; the rest are vectors.
- 3.2** Work, current
- 3.3** Impulse
- 3.4** Only (c) and (d) are permissible
- 3.5** (a) T, (b) F, (c) F, (d) T, (e) T
- 3.6** Hint: The sum (difference) of any two sides of a triangle is never less (greater) than the third side. Equality holds for collinear vectors.
- 3.7** All statements except (a) are correct
- 3.8** 400 m for each; B
- 3.9** (a) O; (b) O; (c) 21.4 km h^{-1}
- 3.10** Displacement of magnitude 1 km and direction 60° with the initial direction; total path length = 1.5 km (third turn); null displacement vector; path length = 3 km (sixth turn); 866 m, 30° , 4 km (eighth turn)

- 3.11** (a) 49.3 km h^{-1} ; (b) 21.4 km h^{-1} . No, the average speed equals average velocity magnitude only for a straight path.
- 3.12** 150.5 m
- 3.13** 50 m
- 3.14** 9.9 m s^{-2} , along the radius at every point towards the centre.
- 3.15** 6.4 g
- 3.16** (a) False (true only for uniform circular motion)
(b) True, (c) True.
- 3.17** (a) $\mathbf{v}(t) = (3.0 \hat{\mathbf{i}} - 4.0t \hat{\mathbf{j}})$ $\hat{\mathbf{a}}(t) = -4.0 \hat{\mathbf{j}}$
(b) 8.54 m s^{-1} , 70° with x -axis.
- 3.18** (a) 2 s , 24 m , 21.26 m s^{-1}
- 3.19** $\sqrt{2}$, 45° with the x -axis; $\sqrt{2}$, -45° with the x -axis, $(5/\sqrt{2}, -1/\sqrt{2})$.
- 3.20** (b) and (e)
- 3.21** Only (e) is true
- 3.22** 182 m s^{-1}

Chapter 4

- 4.1** (a) to (d) No net force according to the First Law
(e) No force, since it is far away from all material agencies producing electromagnetic and gravitational forces.
- 4.2** The only force in each case is the force of gravity, (neglecting effects of air) equal to 0.5 N vertically downward. The answers do not change, even if the motion of the pebble is not along the vertical. The pebble is not at rest at the highest point. It has a constant horizontal component of velocity throughout its motion.
- 4.3** (a) 1 N vertically downwards (b) same as in (a)
(c) same as in (a); force at an instant depends on the situation at that instant, not on history.
(d) 0.1 N in the direction of motion of the train.
- 4.4** (i) T
- 4.5** $a = -2.5 \text{ m s}^{-2}$. Using $v = u + at$, $0 = 15 - 2.5t$ i.e., $t = 6.0 \text{ s}$
- 4.6** $a = 1.5/25 = 0.06 \text{ m s}^{-2}$
 $F = 3 \times 0.06 = 0.18 \text{ N}$ in the direction of motion.
- 4.7** Resultant force = 10 N at an angle of $\tan^{-1}(3/4) = 37^\circ$ with the direction of 8 N force.
Acceleration = 2 m s^{-2} in the direction of the resultant force.
- 4.8** $a = -2.5 \text{ m s}^{-2}$, Retarding force = $465 \times 2.5 = 1.2 \times 10^3 \text{ N}$
- 4.9** $F - 20,000 \times 10 = 20000 \times 5.0$, i.e., $F = 3.0 \times 10^5 \text{ N}$
- 4.10** $a = -20 \text{ m s}^{-2}$ $0 \leq t \leq 30 \text{ s}$
 $t = -5 \text{ s}$: $x = ut = -10 \times 5 = -50 \text{ m}$

$$t = 25 \text{ s} : \quad x = ut + (\frac{1}{2}) at^2 = (10 \times 25 - 10 \times 625) \text{ m} = -6 \text{ km}$$

$t = 100 \text{ s} :$ First consider motion up to 30 s

$$x_1 = 10 \times 30 - 10 \times 900 = -8700 \text{ m}$$

$$\text{At } t = 30 \text{ s, } v = 10 - 20 \times 30 = -590 \text{ m s}^{-1}$$

For motion from 30 s to 100 s : $x_2 = -590 \times 70 = -41300 \text{ m}$

$$x = x_1 + x_2 = -50 \text{ km}$$

4.11 (a) Velocity of car (at $t = 10 \text{ s}$) = $0 + 2 \times 10 = 20 \text{ m s}^{-1}$

By the First Law, the horizontal component of velocity is 20 m s^{-1} throughout.

Vertical component of velocity (at $t = 11 \text{ s}$) = $0 + 10 \times 1 = 10 \text{ m s}^{-1}$

Velocity of stone (at $t = 11 \text{ s}$) = $\sqrt{20^2 + 10^2} = \sqrt{500} = 22.4 \text{ m s}^{-1}$ at an angle of $\tan^{-1}(\frac{1}{2})$ with the horizontal.

(b) 10 m s^{-2} vertically downwards.

4.12 (a) At the extreme position, the speed of the bob is zero. If the string is cut, it will fall vertically downwards.

(b) At the mean position, the bob has a horizontal velocity. If the string is cut, it will fall along a parabolic path.

4.13 The reading on the scale is a measure of the force on the floor by the man. By the Third Law, this is equal and opposite to the normal force N on the man by the floor.

(a) $N = 70 \times 10 = 700 \text{ N}$; Reading is 70 kg

(b) $70 \times 10 - N = 70 \times 5$; Reading is 35 kg

(c) $N - 70 \times 10 = 70 \times 5$; Reading is 105 kg

(d) $70 \times 10 - N = 70 \times 10$; Reading would be zero; the scale would read zero.

4.14 (a) In all the three intervals, acceleration and, therefore, force are zero.

(b) 3 kg m s^{-1} at $t = 0$; (c) -3 kg m s^{-1} at $t = 4 \text{ s}$.

4.15 If the 20 kg mass is pulled,

$$600 - T = 20 a, \quad T = 10 a$$

$$a = 20 \text{ m s}^{-2}, \quad T = 200 \text{ N}$$

If the 10 kg mass is pulled, $a = 20 \text{ m s}^{-2}$, $T = 400 \text{ N}$

4.16 $T - 8 \times 10 = 8 a, \quad 12 \times 10 - T = 12 a$

$$\text{i.e. } a = 2 \text{ m s}^{-2}, \quad T = 96 \text{ N}$$

4.17 By momentum conservation principle, total final momentum is zero. Two momentum vectors cannot sum to a null momentum unless they are equal and opposite.

4.18 Impulse on each ball = $0.05 \times 12 = 0.6 \text{ kg m s}^{-1}$ in magnitude. The two impulses are opposite in direction.

4.19 Use momentum conservation : $100 v = 0.02 \times 80$

$$v = 0.016 \text{ m s}^{-1} = 1.6 \text{ cm s}^{-1}$$

4.20 Impulse is directed along the bisector of the initial and final directions. Its magnitude is $0.15 \times 2 \times 15 \times \cos 22.5^\circ = 4.2 \text{ kg m s}^{-1}$

4.21 $v = 2\pi \times 1.5 \times \frac{40}{60} = 2\pi \text{ m s}^{-1}$

$$T = \frac{mv^2}{R} = \frac{0.25 \times 4\pi^2}{1.5} = 6.6 \text{ N}$$

$$200 = \frac{mv_{\max}^2}{R}, \text{ which gives } v_{\max} = 35 \text{ m s}^{-1}$$

- 4.22** Alternative (b) is correct, according to the First Law
- 4.23** (a) The horse-cart system has no external force in empty space. The mutual forces between the horse and the cart cancel (Third Law). On the ground, the contact force between the system and the ground (friction) causes their motion from rest.
 (b) Due to inertia of the body not directly in contact with the seat.
 (c) A lawn mower is pulled or pushed by applying force at an angle. When you push, the normal force (N) must be more than its weight, for equilibrium in the vertical direction. This results in greater friction ($f \propto N$) and, therefore, a greater applied force to move. Just the opposite happens while pulling.
 (d) To reduce the rate of change of momentum and hence to reduce the force necessary to stop the ball.

Chapter 5

- 5.1** (a) +ve (b) -ve (c) -ve (d) +ve (e) -ve
- 5.2** (a) 882 J ; (b) -247 J; (c) 635 J ; (d) 635 J;
 Work done by the net force on a body equals change in its kinetic energy.
- 5.3** (a) $x > a$; 0 (c) $x < a$, $x > b$; $-V_1$
 (b) $-\infty < x < \infty$; V_1 (d) $-b/2 < x < -a/2$, $a/2 < x < b/2$; $-V_1$
- 5.5** (a) rocket; (b) For a conservative force work done over a path is minus of change in potential energy. Over a complete orbit, there is no change in potential energy; (c) K.E. increases, but P.E. decreases, and the sum decreases due to dissipation against friction; (d) in the second case.
- 5.6** (a) decrease; (b) kinetic energy; (c) external force; (d) total linear momentum, and also total energy (if the system of two bodies is isolated).
- 5.7** (a) F ; (b) F ; (c) F ; (d) F (true usually but not always, why?)
- 5.8** (a) No
 (b) Yes
 (c) Linear momentum is conserved during an inelastic collision, kinetic energy is, of course, not conserved even after the collision is over.
 (d) elastic.
- 5.9** (b) t
- 5.10** (c) $t^{3/2}$
- 5.11** 12 J
- 5.12** The electron is faster, $v_e / v_p = 13.5$
- 5.13** 0.082 J in each half ; -0.163 J
- 5.14** Yes, momentum of the molecule + wall system is conserved. The wall has a recoil momentum such that the momentum of the wall + momentum of the outgoing molecule equals momentum of the incoming molecule, assuming the wall to be stationary initially. However, the recoil momentum produces negligible velocity because of the large mass of the wall. Since kinetic energy is also conserved, the collision is elastic.
- 5.15** 43.6 kW
- 5.16** (b)
- 5.17** It transfers its entire momentum to the ball on the table, and does not rise at all.
- 5.18** 5.3 m s^{-1}

- 5.19** 27 km h⁻¹ (no change in speed)
5.20 50 J
5.21 (a) $m = \rho Avt$ (b) $K = \rho Av^3t / 2$ (c) $P = 4.5$ kW
5.22 (a) 49,000 J (b) 6.45×10^{-3} kg
5.23 (a) 200 m² (b) comparable to the roof of a large house of dimension 14m 14m.

Chapter 6

- 6.1** The geometrical centre of each. No, the CM may lie outside the body, as in case of a ring, a hollow sphere, a hollow cylinder, a hollow cube etc.
6.2 Located on the line joining H and C1 nuclei at a distance of 1.24 Å from the H end.
6.3 The speed of the CM of the (trolley + child) system remains unchanged (equal to v) because no external force acts on the system. The forces involved in running on the trolley are internal to this system.
6.6 $l_z = xp_y - yp_x$, $l_x = yp_z - zp_y$, $l_y = zp_x - xp_z$
6.8 72 cm
6.9 3675 N on each front wheel, 5145 N on each back wheel.
6.10 Sphere
6.11 Kinetic Energy = 3125 J; Angular Momentum = 62.5 J s
6.12 (a) 100 rev/min (use angular momentum conservation).
 (b) The new kinetic energy is 2.5 times the initial kinetic energy of rotation. The child uses his internal energy to increase his rotational kinetic energy.
6.13 25 s⁻²; 10 m s⁻²
6.14 36 kW
6.15 at R/6 from the center of original disc opposite to the center of cut portion.
6.16 66.0 g
6.17 6.75×10^{12} rad s⁻¹

Chapter 7

- 7.1** (a) No.
 (b) Yes, if the size of the space ship is large enough for him to detect the variation in g .
 (c) Tidal effect depends inversely on the cube of the distance unlike force, which depends inversely on the square of the distance.
7.2 (a) decreases; (b) decreases; (c) mass of the body; (d) more.
7.3 Smaller by a factor of 0.63.
7.5 3.54×10^8 years.
7.6 (a) Kinetic energy, (b) less,
7.7 (a) No, (b) No, (c) No, (d) Yes

[The escape velocity is independent of mass of the body and the direction of projection. It depends upon the gravitational potential at the point from where the body is launched. Since this potential depends (slightly) on the latitude and height of the point, the escape

velocity (speed) depends (slightly) on these factors.]

7.8 All quantities vary over an orbit except angular momentum and total energy.

7.9 (b), (c) and (d)

7.10 and **7.11** For these two problems, complete the hemisphere to sphere. At both P, and C, potential is constant and hence intensity = 0. Therefore, for the hemisphere, (c) and (e) are correct.

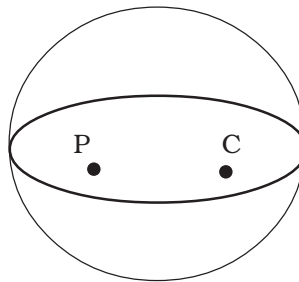

7.12 2.6×10^8 m

7.13 2.0×10^{30} kg

7.14 1.43×10^{12} m

7.15 28 N

7.16 125 N

7.17 8.0×10^6 m from the earth's centre

7.18 31.7 km/s

7.19 5.9×10^9 J

7.20 2.6×10^6 m/s

7.21 0, 2.7×10^{-8} J/kg; an object placed at the mid point is in an unstable equilibrium

© NCERT
not to be republished